

Cleaner

FOR DRAIN AND PIPE CLEANING, INSPECTION AND REHABILITATION PROFESSIONALS

www.cleaner.com | MAY 2016



STARRING IN A SUPPORT ROLE

SEWER AND DRAIN CLEANING COMPANY BUILDS ITS REPUTATION
AS AN EXTENSION OF THE LOCAL PLUMBING INDUSTRY **PAGE 34**

MONEY MACHINES

Portable inspection for tight places

TOUGH JOB

Seven months of large-diameter rehab

BETTER BUSINESS

Don't give in on your prices

Mini-Jet Mini-Price

Starting at just
\$975 US



Special Introductory Offer

Spray Wand included **FREE**
with purchase of complete unit.

For more info: www.drainbrain.com/jets

You don't always need a heavy duty jetter to clear a clogged drain. General's JM-1000 Mini-Jet™ brings surprising cleaning power to the job. And with its light weight, you'll be blasting away before you could get your big jetter off the truck and into position.

Clear small lines, clogged sinks, and laundry drains from 1-1/2" to 3" in diameter – up to 75 feet long – with 1500 pounds of thrust. Pulse technology helps slide the hose around tight bends and farther down lines.

At only 22 lbs, General's tough Mini-Jet resists job-site abuse, too. The pump and motor assembly are safely contained in a rugged diamond plate metal case.



Pound for pound and dollar for dollar, the Mini-Jet is a great (and small) investment.

For more information, contact the Drain Brains® at General at 800-245-6200 or 412-771-6300, or visit www.drainbrain.com/jets.



General
PIPE CLEANERS

The toughest tools down the line.™



© General Wire Spring 2016



MARIA
MAKES SURE WE
DON'T HAVE
ANY INVENTORY
ISSUES.

DARN
SURE.

Because building tough reliable trucks
takes tough reliable people.

With over 15 years at Vac-Con, nothing gets moved out of inventory without Maria knowing about it. Maria lives out "more power to you" every day. It's not just our tagline, it's in everything we do: our technology, our culture, and our leadership. Yes, our trucks are engineered to be powerful, but they're also built by smart people who keep the end-users in mind. They give you a machine that gets the job done. **GO ON-LINE TO LEARN MORE.**

VAC-CON.COM

VAC-CON IS A SUBSIDIARY OF HOLDEN INDUSTRIES, INC.. A 100% EMPLOYEE-OWNED COMPANY



VAC-CON
MORE POWER TO YOU

A HOLDEN INDUSTRIES Company

WGR SWITCHER™

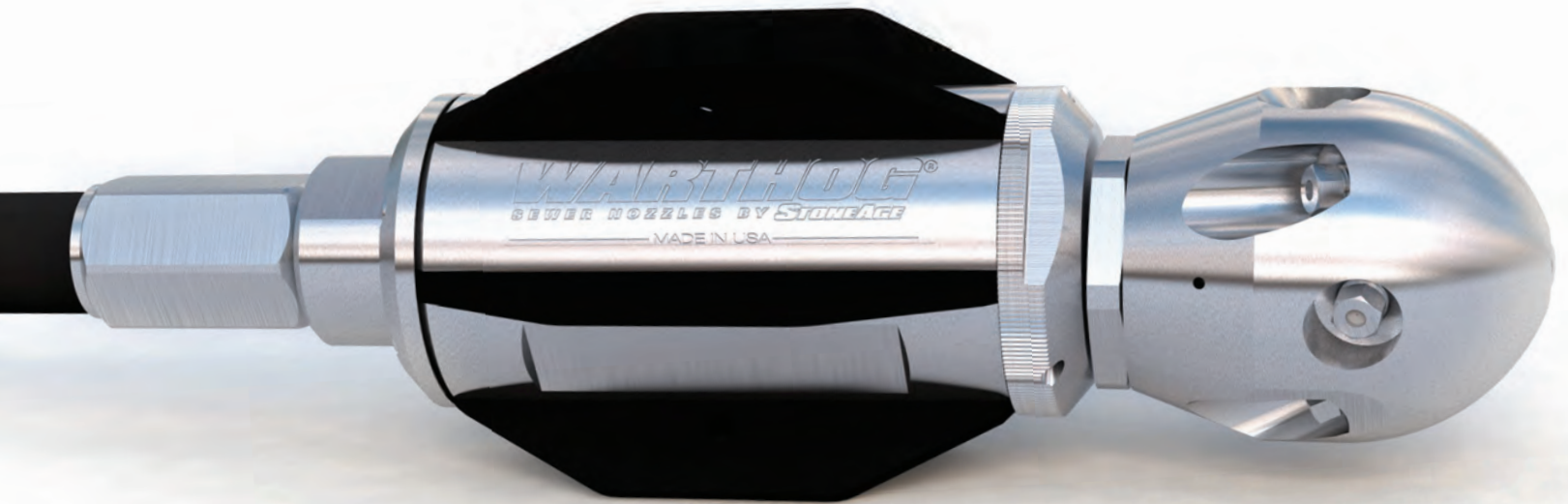

SWITCH FROM CLEANING TO FLUSHING
WITHOUT EVER LEAVING THE PIPE.



SEE HOW IT WORKS:
WWW.STONEAGETOOLS.COM/SWITCHER

WARTHOG
SEWER NOZZLES BY **StoneAge**®

1-866-795-1586 • WWW.SEWERNOZZLES.COM

Proudly Manufactured in the USA



An instant, wireless View into any sewer.



Sewer assessment—it's essential to prioritizing CCTV and maintenance work, planning cleaning and rehab, and achieving compliance. Controlled wirelessly with a touchscreen tablet, the patented new **Quickview airHD** camera lets you look inside any sewer with:

No cables at all!

Touchscreen control

Detailed HD video

In-manhole centering

Motorized tilt

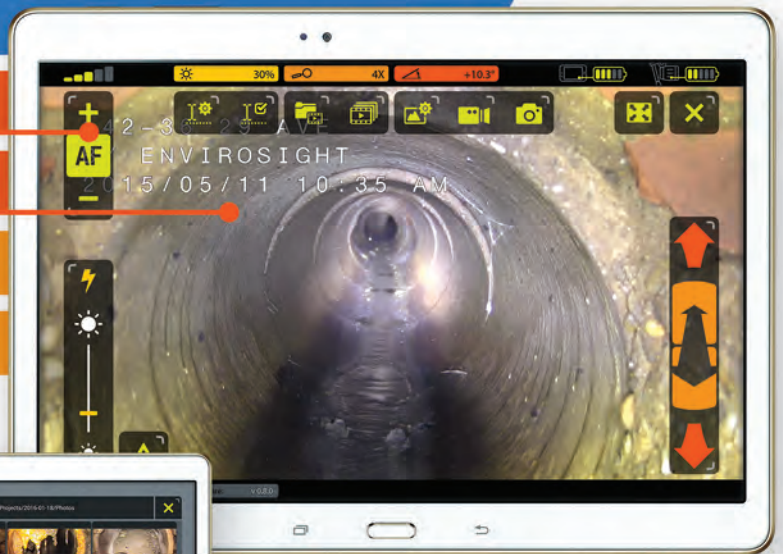

Full wireless control, viewing, recording, annotation, playback and sharing capabilities.

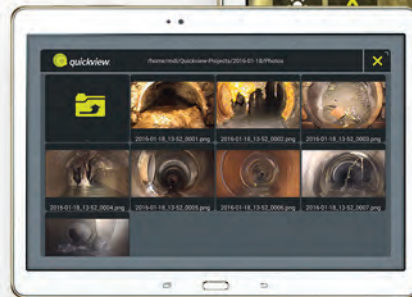

Phased Assessment Strategy for Sewers (PASS) starts with zoom assessment. This FREE white paper explains why: envirosight.com/pass



get a **demo**

Envirosight

envirosight.com/airhd • (973) 252-6700

Full range of underground infrastructure inspection equipment, service and rentals.



departments

- 12 **From the Editor: Traveling a Different Path**
Don't be afraid to look for a new way to make your business stand out.
By Luke Laggis
- 14 **@cleaner.com**
Be sure to check out our exclusive online content.
- 30 **Money Machines: Remote Patrol**
Portable camera system reaches pipes in places typical CCTV trucks would dare not venture.
By Ken Wysocky
- 42 **WWETT Spotlight: Two for One**
Jetstream's TwinForce waterblasting system handles any job, big or small.
By Kyle Rogers
- 46 **Money Manager: Keep On Deducting**
Now that a strong federal tax benefit for equipment purchases is permanent, it's time to think more strategically about machinery purchases.
By Erik Gunn
- 50 **Better Business: Win the Sale Without Losing on Price**
Use these strategies to turn price objections into opportunities to educate your customers.
By Judy Kneiszel
- 58 **Tough Job: Night Moves**
Contractor gets creative with work schedule to minimize disruptions while rehabbing more than 5,000 feet of sewer interceptor.
By Kyle Rogers
- 64 **Product Focus:**
Residential and Commercial Sewer and Pipe Maintenance
By Craig Mandli
- 73 **Case Study:**
Residential and Commercial Sewer and Pipe Maintenance
By Craig Mandli
- 76 **Product News**
Product Spotlight: Water Cannon duct cleaners attach to any pressure washer.
By Luke LeNoble
- 78 **Industry News**

features

- 18 **Profile: Lining the Path to Success**
Co-workers take experience and customer service focus and turn it into a profitable business.
By Ken Wysocky
- 34 **Profile: Starring in a Support Role**
Sewer and drain cleaning company builds its reputation as an extension of the local plumbing industry.
By Marian Bond
- 54 **Portable Jetter & Cable Machine Company Directory**



ON THE COVER:

Plumber's Service has built a strong reputation providing sewer and drain cleaning services for plumbing contractors in the Greater Detroit area. The team includes (from left) Jim Simpson, Brandon Myre and owner Jeff Goan. (Photo by Amy Voigt)

COMING IN JUNE 2016

ISSUE FOCUS:

Location and Leak Detection, Drainline TV Inspection Equipment

- **SAFETY FIRST:** Tougher laws protect workers
- **MONEY MANAGER:** Prepare for life after work
- **TECH PERSPECTIVE:** The low-down on high-tech locators

TWO SOLUTIONS FOR LATERAL REHABILITATION

PERMA-LATERAL™ LINING

REHABILITATING RESIDENTIAL HOME
LATERALS TO MAIN SEWER.
PATENTED TECHNOLOGY.



INNERSEAL™

REHABILITATING TEE AND WYE CONNECTIONS
FROM THE CITY SEWER MAIN TO RESIDENTIAL
SEWER LATERALS. PATENTED TECHNOLOGY.
MEETS ASTM F2561-11.



TURN-KEY BOX TRUCKS

ZERO DOWN FINANCING
NO PAYMENTS FOR 90-DAYS

TURN-KEY TRAILERS



AFTER

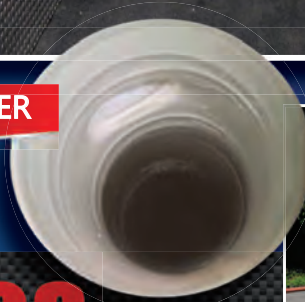

AFTER



LIVE DEMOS

MAY 4 - CHICAGO
MAY 18 - PHILADELPHIA

PERMA-LINER™
INDUSTRIES, LLC.

www.perma-liner.com

CALL
1-866-336-2568
TO LEARN MORE



NEED CIPP LINER?

SEE MTC.

WE PROVIDE:

- CIPP liner (4" to 120")
- Pressure pipe
- Full-wrap laterals
- Point repair kits
- Install equipment
- Field support
- Easy payment



844.593.6946
manufacturedtechnologies.com

TRYTEK 3" to 6" Lateral Cutter

NEW! TRYDENT 80 Cutter System

- > For interior or exterior relined pipes
- > Access pipe systems through clean-out ports or rooftop vents
- > Navigate standard 90 degree elbows in 3" pipe
- > Includes 100' of hose reach



www.trytek.com

Contact us for more information:
Phone: 717-428-1477
 Fax: 717-428-2865
 Email: trytek@trytek.com
 250 N. Main St.
 Jacobus, PA 17407 USA

Serving the
 industry for over
25 years

Cleaner

FOR DRAIN AND PIPE CLEANING, INSPECTION AND REHABILITATION PROFESSIONALS

Published monthly by COLE Publishing, Inc.

1720 Maple Lake Dam Rd., PO Box 220, Three Lakes, WI 54562

Call toll-free 800-257-7222 | Outside of U.S. or Canada call 715-546-3346
 Mon-Fri., 7:30 a.m.-5 p.m. CST

Website: www.cleaner.com | Email: info@cleaner.com | Fax: 715-546-3786

SUBSCRIPTION INFORMATION: A one year (12 issue) subscription to *Cleaner* in the United States or Canada is free to qualified subscribers. A qualified subscriber is any individual or company in the United States or Canada that is involved in the inspection, cleaning, repair and installation of residential and commercial sewer lines. Non-qualified subscriptions are available at a cost of \$60 per year in the United States and Canada/Mexico. Subscriptions to all other foreign countries cost \$80 per year. To qualify, visit www.cleaner.com/order/subscription or call 800-257-7222.

Our subscriber list is occasionally made available to carefully selected companies whose products or services may be of interest to you. Your privacy is important to us. If you prefer not to be a part of these lists, please contact Nicole at nicole@colepublishing.com.

CLASSIFIED ADVERTISING: Submit classified ads online at www.cleaner.com/classifieds/place_ad. RATE: No Photo Classified \$25 for 20 words, each additional word \$1. All classified advertising must be PAID IN ADVANCE. DEADLINE: Classifieds must be received by the first of the month for insertion in the next month's edition. PHONE-IN ADS ARE NOT ACCEPTED. Ads may be faxed only when charging to MasterCard, VISA, Amex or Discover. Please supply all credit card information with faxed ads. Be sure to include your phone number (with area code) in your ad. Make checks payable to COLE Publishing Inc. and mail with classified ad to the address above. CLASSIFIED ADVERTISING APPEARS NATIONWIDE AND ON THE INTERNET. Not responsible for errors beyond first insertion.

DISPLAY ADVERTISING: Contact one of our sales staff at 800-994-7990. Publisher reserves the right to reject advertising which in its opinion is misleading, unfair or incompatible with the character of the publication.

REPRINTS AND BACK ISSUES: Visit www.cleaner.com for options and pricing. To order reprints, call Jeff Lane at 800-257-7222 (715-546-3346) or email jeffl@colepublishing.com. To order back issues, call Nicole at 800-257-7222 (715-546-3346) or email nicole@colepublishing.com.

CIRCULATION: Circulation averages 26,460 copies per month. This figure includes both U.S. and international distribution.

© 2016 COLE Publishing Inc.

No part may be reproduced without permission of the publisher.



Kayla Bisnette Jim Koshuta



- www.facebook.com/CleanerMag
- www.twitter.com/CleanerMagazine
- www.plus.google.com
- www.youtube.com/CleanerMagazine
- www.linkedin.com/company/cleaner-magazine



SEPTEMBER 12-13, 2016
 WISCONSIN STATE FAIR PARK,
 MILWAUKEE, WISCONSIN



FEBRUARY 22-25, 2017
 Indiana Convention Center,
 Indianapolis, Indiana
www.wwettshow.com

PROVEN FUNCTIONALITY AND VERSATILITY. NEW TECHNOLOGY.

RIDGID® COMPACT2 INSPECTION SYSTEM

Introducing our CS6Pak digital recording monitor and Compact2 camera reel.

Redesigned to provide easier transport and smoother docking of the monitor to the reel, this system is simple to use. Best of all, the added self-leveling camera head and digital recording capabilities allow you to easily view and share your inspection footage with anyone, anywhere.

©2016, RIDGID, Inc. The Emerson logo and RIDGID logo are registered trademarks of Emerson Electric Co. or RIDGID, Inc. in the U.S. and other countries. All other trademarks belong to their respective holders.

★ REQUEST A FREE ONSITE DEMO AT 800.769.7743 | RIDGID.COM/COMPACT2 ★

RIDGID

EMERSON
Commercial & Residential Solutions

A

A.R. North America, Inc.79

ALLAN J. COLEMAN
SINCE 1965

Allan J. Coleman Co. 23, 67

AMAZING MACHINERY

Amazing Machinery, Inc.51

AQUA MOLE

Aqua Mole Technologies, Inc. 32

ARIES INDUSTRIES, INC.

Aries Industries, Inc.49

Arthur Products Co.56

C

Cable Center, The 28, 75

CAM SPRAY

Cam Spray48

CAT PUMPS

Cat Pumps37

CENTRAL OKLAHOMA WINNELSON

Central Oklahoma Winnelson 40

CIPP SERVICES, LLC

CIPP Services, LLC16

CLOVERLEAF TOOL CO.

Cloverleaf Tool Co.32

COAST MANUFACTURING

Coast Manufacturing52

COXREELS

Coxreels52

CUES

CUES57

D

DEEP TREKKER
Exploring New Horizons

Deep Trekker60

DRAINABLES DIRECT

Drainables Direct15

DURACABLE
Manufacturing Company

Duracable Manufacturing Co.63

E

Electric Eel

Electric Eel Mfg.26

Envirosight

Envirosight, LLC5

enz usa inc.

Enz USA, Inc.40

F

Solutions

F. S. Solutions41

Forbest Products Co.32

G

GapVax

GapVax, Inc.87

General PIPE CLEANERS

General Pipe Cleaners2

GORLITZ SEWER & DRAIN, INC.

Gorlitz Sewer & Drain, Inc.45

GUZZLER

Guzzler Manufacturing11

H

Hannay Reels
The real leader

Hannay Reels59

J

Jetstream

Jetstream of Houston53

JETTERS NORTHWEST33

K

Ken-Way Corporation81

L

Lansas

Lansas Products20-21

LaPlace Equipment Co.26

LIBERTY FINANCIAL
Financial Group

Liberty Financial Group39

M

MRP

Milwaukee Rubber Products, Inc.79

Mongoose Jetters

Mongoose Jetters by Sewer Equipment ...61

MTC8

MyTana

MyTana Mfg. Company, Inc.43

N

NLB Corp.

NLB Corp.17

NozzTeq

NozzTeq, Inc.74

O

OceanQuip LLC

Oceanquip Cables, LLC44

P

PERMA-LINER INDUSTRIES, LLC

Perma-Liner Industries, LLC7

Petersen Products Co.26

PICOTE SOLUTIONS

Picote Solutions28

Pipeline Analytics

Pipeline Analytics52

PIPELOGIX

PipeLogix, Inc.69

Piranha Hose Products69

PRIMELINE

PrimeLine Products, Inc.39

Pulsar 2000 Line Tracer

Pulsar 2000, Inc.44

Q

Quik-Lining Systems, Inc.12

R

R.S. Technical Services, Inc.31

RapidView IBAK North America27

Ratech ELECTRONICS

Ratech Electronics, Ltd.47

REELCRAFT INDUSTRIES, INC.62

RIDGID

RIDGID9

Root Rat

Root Rat44

ROOTX

RootX13

S

SCOOTER VIDEO

Scooter Video71

Sewer Equipment Co. of Nevada48

SOUTHLAND TOOL MFG. INC.

Southland Tool Mfg., Inc.25

SPARTAN

Spartan Tool, LLC88

STONEAGE

StoneAge, Inc.4

T

T&T TOOLS

T&T Tools, Inc.74

Trenchless Solutions, Inc.74

TRYTEK

TRY TEK Machine Works, Inc.8

TST Sweden AB69

U

UltraSHORE PRODUCTS

Ultra Shore56

V

VAC-CON

Vac-Con, Inc.3

VACALL

Vacall - Gradall Industries29

VARCO

VARCO56

VIVAX METROTECH

Vivax-Metrotech Corp.16

VSI Rentals62

W

WATER CANNON

Water Cannon, Inc. - MWBE86

Westmoor Ltd.48

Marketplace 80-81

Classifieds 82-84

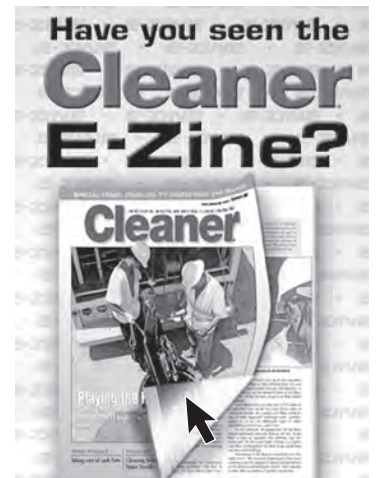

Go to **cleaner.com** to view the e-zine.

Cleaner It's FREE! Subscribe online at www.cleaner.com



Your Guzzler comes with a pit crew



Guzzler is a registered trademark of Guzzler Manufacturing.
©2015 All Rights Reserved.

When you buy a Guzzler®, you get more than the toughest, most reliable industrial vacuum truck in the business. You also get the full backing of the Guzzler team – for parts and service, round-the-clock support, training, consulting and industry expertise. Think of us as the pit crew dedicated to taking care of you and your truck. We can even help you expand your business by exploring new markets and applications for your Guzzler truck. With your Guzzler pit crew, the competition can eat your dust.

**For a demo or to meet your Guzzler pit crew,
call 800-627-3171 or visit www.guzzler.com/pitcrew.**

Guzzler products are serviced and supported by FS SolutionsSM



Luke Laggis
editor@cleaner.com

Traveling a Different Path

Don't be afraid to look for a new way to make your business stand out

By Luke Laggis

like it when people go against the grain. If you follow everyone else, you're likely to get the same results as everyone else. That might be acceptable, but it's never going to be exceptional. Some people have a bigger vision.

Both of the companies profiled in this issue of *Cleaner* have chosen their own routes to success. Plumber's Service has spent six decades serving as the drain cleaning extension of countless plumbing businesses in the Greater Detroit area. It was the vision of company founders Richard and Millie Goan right from the start. Subcontracting was nothing new, but the Goans looked at it differently. They wanted to carve out a strong reputation with a sort of nonidentity.

They recognized that the majority of plumbers in their operating area were ill-equipped to effectively handle drain cleaning jobs and sought a

partnership where they could become a high-quality and noncompetitive extension of the plumber's business. Plumber's Service does not advertise. There are no wraps on their trucks. When they're working as subcontractors, customers for the most part think they are the plumbing company that hired them.

The fact that the model is still working today speaks to its inventiveness, and to the quality with which the company, now under the leadership of the Goans' son, Jeff, carries out its mission. They focus on drain cleaning and rehabilitation and let plumbers focus on what they do best.

Liner Guys hasn't been around anywhere near as long, but the company established a niche that's every bit as effective and valuable. Partners Steve Stefanidis and Mike Rodger established the company with a narrow focus on sewer lateral cleaning, inspection and rehabilitation. They both had experience and they knew there was opportunity in their market.

The London, Ontario, market the company serves is composed of mostly older homes with aging lateral connections, providing a good potential customer base. On top of that, there aren't many competitors providing the same services, and none who specialize like Liner Guys.

Stefanidis and Rodger used their knowledge and experience to identify a space in which they could prosper, and then set out to educate their potential customer base about the ways in which Liner Guys' services could help them.

In a few short years, the company has been able to establish its position and create demand for its services, with gross revenue increasing about 30 percent in each of the last two years.

Providing an alternative to traditional lateral replacement created a foundation for Liner Guys' success. An alternative customer base made the difference for Plumber's Service. Neither company followed the common path.

Fitting in might be comfortable, but sometimes standing out is the only way to be truly successful. Don't be afraid to look for a new way. Don't be afraid to take a chance if it's something you believe in.

Enjoy this month's issue. **C**

Your **TRUSTED** Lateral Lining Manufacturer!

Quik-Lining Systems

CALL TODAY!
605-695-6778

Quik-Lining Systems offers a revolutionary line of Lateral Lining Inversion Equipment for the installation of **Cured In Place Pipe**.

Our equipment saves TIME and MONEY

Can be used in even the most confined spaces!

CONTACT US FOR MORE INFORMATION // 605-695-6778

WWW.QUICKLINING.COM
E-MAIL // JOHN@QUICKLINING.COM

LIKE SOMETHING? HATE SOMETHING? AGREE? DISAGREE?

Share your opinions about *Cleaner* articles through our Letters to the Editor.

Send a note to editor@cleaner.com |



ROOTX



**“GREASE-X DOES
WHAT IT USED
TO TAKE US
WEEKS TO DO.”**

Chad Hunter
Bullhead City, AZ Sewer Utility

THE RIGHT SOLUTION. RIGHT NOW.

Chad Hunter and his crews in the City of Bullhead City Arizona's Sewer Utility had their hands full. Trying to deal with six feet of grease in their lift stations, it was taking their vacuum trucks weeks to get the job done.

Then they started using Grease-X, the proven, easy-to-use way to get rid of fat, oils, and grease. (FOG) Grease-X emulsifies FOG from lift stations and you use Grease-X with your crews, your equipment, and on your own schedule.



GREASE-X



Ready to find out more?

Email us at rootx@rootx.com, or give us a call at 1-800-844-4974.

www.rootx.com

@Cleaner.com

Visit the site daily for new, exclusive content. Read our blogs, find resources and get the most out of *Cleaner* magazine.

OVERHEARD ONLINE

“Don't make the mistake of absorbing every new equipment purchase into your overhead. Where ROI is most easily calculated is when you can bill the equipment directly to the customer.”

— Is New Equipment Worth the Investment?
>>cleaner.com/featured

LEGAL MATTERS

Whistleblower Rights: What You Should Know

If you noticed a legal, health or safety violation on the job site, what would you do? Fortunately, most problems can be resolved internally. But when circumstances are dire, here's what you should know about becoming a whistleblower.

>>cleaner.com/featured



WAVE OF OPPORTUNITY

Cleaners Cash in on El Niño

Contractors throughout California were prepared when the rains began to fall earlier this year, and keeping up with long-neglected sewers and drains have kept residential and commercial cleaners in high demand. Find out how they've been working with customers to keep the stormwater flowing.

>>cleaner.com/featured



WATERBLASTING BASICS

Proper PPE Worth the Investment

Every day, waterjetting contractors needlessly expose their employees to serious injuries — possibly even death — and make their companies vulnerable to negligence lawsuits that all could be avoided by a small investment in personal protective equipment. Take the first step and learn about the three essential pieces of PPE every high-pressure jetter operator needs.

>>cleaner.com/featured



Emails and Alerts

Visit Cleaner.com and sign up for newsletters and alerts. Get exclusive content delivered right to your inbox and you'll stay in the loop on topics important to you!

Join the Discussion



Find us on
Facebook at facebook.com/CleanerMag



or
Twitter at twitter.com/CleanerMagazine



RIDGID[®]

REPAIR CENTER

**YOUR ONE-STOP CERTIFIED
REPAIR & SUPPLY LOCATION**

- RIDGID FACTORY TRAINED & CERTIFIED REPAIR SHOP
- EXPEDITED SERVICE AVAILABLE
- MACHINE & CAMERA REPAIR



DRAINABLES.COM
800.421.4580

SCHEDULE YOUR REPAIR
CALL TODAY!

vCam-5

Inspection Camera

VIVAX
METROTECH
www.vivax-metrotech.com

- Locatable Pushrod
- Interchangeable Camera Heads
- Stainless Steel Construction
- Field Serviceable Spring Terminations

Training Provided Free of Charge

VM-540 Locator



Mini Reel



**200 Foot
Type-CP**

Please call us to schedule an on site, no obligation demonstration!

Vivax-Metrotech Corporation

3251 Olcott Street, Santa Clara CA 95054, USA
 Toll Free: +1-800-446-3392 Tel: +1-408-734-1400
 Fax: +1-408-734-1415 Email: sales@vxmt.com

Can't Find Light Bulbs ?

Don't Scrap A Camera



Upgrade To LED Lights

- Increased Light Output
- Long-life LEDs
- Shock Resistant - Durable
- Cooler - Warm To the Touch
- Extended Life With Minimal Investment

Refurbished Units & Camera Modules Available

Available For Most Camera Brands

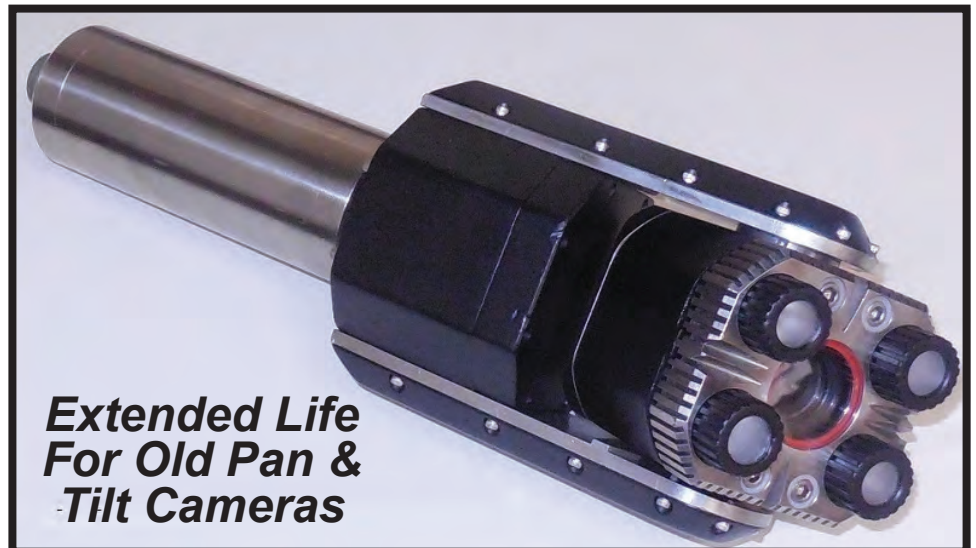

**Extended Life
For Old Pan &
Tilt Cameras**

CIPP Services, Inc. ■ www.cipp-services.com ■ sales@cipp-services.com ■ 815-712-8708

RUNS STRONGER. RUNS LONGER.



DEPENDABILITY MATTERS.

For over forty years, NLB water jetting pumps have set the standard for reliability and durability. If you are looking to increase your productivity and profitability, look to NLB Corporation.



(800) 227-7652 | NLBCORP.COM

www.cleaner.com • Since 1985 May 2016 17

LINING THE PATH TO SUCCESS

CO-WORKERS
TAKE EXPERIENCE
AND CUSTOMER
SERVICE FOCUS
AND TURN IT INTO
A PROFITABLE
BUSINESS

BY KEN WYSOCKY
PHOTOGRAPHY
BY BRUCE BELL



Liner Guys co-owner Mike Rodger monitors the air pressure on an LMK lateral inversion tank while lining a residential sewer lateral.

STEVE STEFANIDIS AND MIKE RODGER ESTABLISHED LINER GUYS BASED ON A PHILOSOPHY AS SIMPLE AND STRAIGHTFORWARD AS THE NAME: **USE THE BEST TECHNOLOGY AVAILABLE TO PROVIDE THE BEST CUSTOMER SERVICE POSSIBLE.**

Judging by the lateral lining company's growth — about a 30 percent increase in gross revenue in each of the last two years — the no-nonsense approach is paying dividends in a competitive lateral lining market in and around London, Ontario.

"We're a customer first kind of business," says Stefanidis, who handles sales and marketing for the company, while Rodger supervises field operations. "Good customer service is rare in today's society. But we believe that customer service requires exactly what it says it is: You bend over backward to do whatever you can for every customer.

"You know you're doing something right when a customer gives you the keys to their home and says, 'I trust you,'" he adds, noting that customers periodically do just that. "That's a major responsibility. I don't always feel comfortable when they do that, but so far it's worked out well."

Customer service informs virtually every aspect of the company, from embracing advanced technology that minimizes disruption for homeowners and helps employees finish jobs faster to setting high hiring standards for employees who can interact properly with customers. It also includes educating customers about the advantages of no-dig technology, which is still relatively unknown in the regional market the company serves, Stefanidis says.

Steve Stefanidis (left) and Mike Rodger formed Liner Guys in 2012 in London, Ontario, focusing on lateral cleaning, inspection and lining.



“You know you’re doing something right when a customer gives you the keys to their home and says, ‘I TRUST YOU.’ THAT’S A MAJOR RESPONSIBILITY.”

Steve Stefanidis



<< **LEFT:** Steve Stefanidis feeds a RIDGID SeeSnake camera into the inversion tank's camera port to confirm that the liner is inflating properly.

>> **RIGHT:** Dennis Matthew lubricates the outside of a liner while he and Steve Stefanidis load it into the lining unit.

Lansas[®] PRODUCTS

Manufactured by Vanderlans & Sons, Inc.



MANHOLE VACCUUM TESTING

Lansas has a full line of vacuum testing components and kits available.

21" - 27" Multi-Size Vacuum Test Head and Super Vac™.



"SMART BOX™" LINE ACCEPTANCE TEST KIT

From plugs to panels we manufacture all components needed for line acceptance and leak locating.



JOINT TESTER

We have joint testers available in single and double bladder designs for pipe sizes 24" - 144". These units are available in high and low pressure models for use in pipe lines which allow up to 5% deflection.

SST PLUGS

Single Size Test Plug (SST) with smart air test triple hose.





profile

LINER GUYS, INC. LONDON, ONTARIO

FOUNDED: 2012
OWNERS: Steve Stefanidis and Mike Rodger

EMPLOYEES: 4
SPECIALTIES: Sewer lateral inspections, cleaning and lining

SERVICE AREA: 200-mile radius around London

WEBSITE: www.linerguys.ca

Even the company name (Rodger's idea) is intended to make things easier for customers. "We threw a thousand ideas out there and Liner Guys just stuck," Stefanidis recalls. "It was just the two of us back then and it defined the basis of our business. We wanted to convey that we are the guys for lateral lining. It's just that simple."

GETTING STARTED

Rodger and Stefanidis met while they were working for another lining company. After Stefanidis left the firm in 2012, he told Rodger to call him if he ever wanted to form a company on their own. "He called me a week later and asked me if I was serious," Stefanidis says. "We then held a meeting with our families and that was the birth of our lovely business."

The duo was excited about business prospects because market research showed that 70 percent of the city's homes are more than 30 years old — a total of approximately 30,000 homes in all. "We figured it could be profitable for us even if we worked on just 30 percent of those homes," Stefanidis says. "And there are lots of townships around us with homes that are even older than that ... so the business looked very lucrative. The infrastructure here is getting old, and the technology is incredible. It's still amazing to me how we can inject a liner into a pipe and three hours or so later, we have a perfectly formed plastic pipe inside the old one."

To enhance customer service, the duo invested in a CIPP lining system from LMK Technologies. The company also relies on a 34-foot-long wet-out trailer (where the pipe liner gets impregnated with resins prior to installation) made by Atlas Specialty Trailers, and a Hitachi generator.

"We like the LMK system because the inversion tank has a camera port where we can insert our SeeSnake camera and watch the liner inflate," Stefanidis says. "It's much better to be able to see that the liner is open at both ends, rather than guessing."

The company also owns four RIDGID SeeSnake inspection cameras with CS10 color monitors; two RIDGID Scout locators; four RIDGID cutting heads, used for scouring pipelines; a milling machine, made by Picote Solutions, for reinstating laterals; and two Ford F-150 pickup trucks.



CUSTOM JOINT TESTER

This joint tester was designed and built for a water project near Phoenix, Arizona.

Each joint of this 21' diameter pipeline was tested at 32 PSI.

*Custom Designs
Are Always™ Available*

VANDERLANS AND SONS, INC.

California 1-800-452-4902

Atlanta 1-770-509-9309

Chicago 1-800-452-4902

Houston 1-832-831-4458

www.lansas.com



EMPLOYEE PREFERENCES

Stefanidis says he and Rodger are very particular about who they hire to use all this equipment. Employees must be able to not only grasp the intricacies of lining, but also respect and interact well with customers. That includes refraining from smoking, littering and swearing on job sites.

“It’s not difficult to find employees,” he explains. “It’s just difficult to find employees who take pride in their work — who work the way we want them to work. We’re pretty fussy about how our employees interact with customers. We want employees who treat our business like it’s their own.”

There’s a reward for employees who make the grade: no boss/employee hierarchy. “There’s no boss or supervisor in our company,” he says. “We work hand in hand with each other. We don’t want our employees to look at us as bosses, but we also don’t want them to take advantage of that kind of mentality. Our philosophy is let’s all work hard for a good day’s pay and everyone goes home happy.”

When it comes to training, Stefanidis doesn’t think pipe lining is difficult to learn, but he says there’s definitely an art to it, and employees are lucky to have Rodger as a teacher.

“Mike is definitely an artist at lining — he’s a natural. He lives and breathes this stuff. He’s cool, calm and collected and believes that no matter what he comes across, we’ll dive in and fix it.

“He wants things perfect and pristine,” Stefanidis adds. “We take a lot of pride in our work — it truly matters to us that customers are happy.”

EDUCATION IS CRITICAL

Getting people to understand that they don’t have to dig up failing laterals — and deal with the resulting inconveniences created by excavation — remains an uphill battle. Even though trenchless technology has been around for decades, Stefanidis says he still encounters people every day who don’t know the technology exists. “That’s our biggest challenge — changing that dig-it-up mentality.”

CONTINUED >>



Steve Stefanidis does a post-lining inspection with a RIDGID SeeSnake camera and CS10 color monitor.

FREE LATERAL INSPECTIONS GENERATE NEW BUSINESS

An old adage says there’s no such thing as a free lunch, but in London, Ontario, there *is* such a thing as a free lateral inspection, courtesy of Liner Guys Inc.

The free inspections serve two purposes: They generate job leads and differentiate the company from its competitors, says Steve Stefanidis, who co-owns the company with Mike Rodger.

“It gets our foot in the door,” Stefanidis says. “Sure, it’s an expense for us, but getting the lead is worth the expense.”

There is one caveat involved: The inspection is free only if a customer has a problem with a lateral, as opposed to people who, for example, are selling a home and want a free inspection so they can tell prospective buyers the lateral is in good condition. “We charge a fee for those kinds of inspections,” he says.

What if a legitimate customer gets an inspection that reveals a problem, but doesn’t choose Liner Guys to fix it? “We shake their hand, leave a business card with our phone number and tell them to call us if they need us,” he says. “We don’t pressure anyone. And if the lateral is in good condition, we tell them. If there’s a problem, we tell them. If they want a quote, we provide one. There are never any strings attached.

“If no repair is required, the customer is usually happy with the news and they’re going to tell five or six other people how honest we are. ... And then they’re also more likely to call you back when a problem does occur,” he adds.

Stefanidis estimates that in eight out of every 10 inspections, Liner Guys gets the job to reline or clean a lateral. A key factor in that success rate: Customers can watch the inspection on a monitor and see any problems firsthand. If the customer wants a copy of the inspection on a thumb drive or a DVD, the company charges a modest fee.

The company also performs inspections for local plumbers upon request, but they’re not free. So what stops a plumber from circumventing the fee by telling a customer to call Liner Guys and ask for a free inspection? Absolutely nothing, Stefanidis concedes. “There are always companies out there with less integrity than ours,” he says. “It’s a cost of doing business. When you own a company, those are the hills you climb.”

ALLAN J. COLEMAN

SINCE 1905

Call us today!
773-728-2400

5725 North Ravenswood Avenue • Chicago, IL 60660 • info@allanjcoleman.com • www.allanjcoleman.com

OLDEST NAME IN THE BUSINESS — Over 100 YEARS OLD

CS65 Digital Reporting Monitor

- One touch recording
- 1 TB internal hard drive
- 6.5" Daylight viewable LCD display
- Water-resistant keypad
- SeeSnake HQ Software



SeeSnake® MAX rM200 Camera System

- Next Generation Push Cable and Improved Reel Mechanics
- Ultra Compact Camera Head
- Transport Enhancements
- Docking System • Self-Leveling Camera Head



SeeSnake® CS6 Digital Recording Monitor

- Direct-to-USB recording for fast, efficient documentation of inspection jobs
- Water-resistant keypad for direct control of essential camera and monitor functions
- Daylight viewable display for a crisp, clear in-pipe image
- SeeSnake HQ Software to edit, archive, and deliver reports via print, DVD, or online
- On-screen keyboard for basic titling and text entry
- CS6 will dock in the RM-200 Max or operate as a stand alone monitor



RIDGID®

SeeSnake® Mini Camera Reel

- 1 1/2" to 6" Lines up to 200'
- New Self-Leveling Camera Head
- Built-In 512 Hz Sonde
- Metal Frame and Rugged Drum



SR-24 Line Locator with Bluetooth® and GPS

- Omnidirectional antennas
- Large display • Built-In GPS
- Bluetooth® technology
- Smartphone/Tablet App
- Can trace any frequency from 10 Hz to 35,000 Hz



MR-10 Magnetic Locator

- Quickly locate buried iron or steel objects
- Ergonomic rugged design includes carrying case and batteries
- Highly sensitive instrument with audio and visual feedback
- AutoNull feature blocks out nearby metallic interference such as an automobile



SeekTech® SR-20

SeekTech uses omni-directional antennas, guidance arrows and an easy to read mapping display.



NaviTrack® Scout®

Scout is designed to solve demanding remote transmitter (sonde) locates using multi-directional locating technology.

Authorized SeeSnake Repair Center

THE BEST SERVICE AND FAST TURN AROUND!

We Have RIDGID Parts!

If you buy the best, you are only sorry once!

The company employs several strategies to educate customers and make them feel comfortable with the technology. The company's website is its primary education tool, which features nearly a dozen videos — some of their own and some from LMK — that explain various aspects of no-dig technology. "You can explain it all day long, but when someone sees what a finished pipe looks like, there's an 'aha' moment," Stefanidis says, explaining the value of videos.

Stefanidis also shows customers samples of lined pipes, including one where they can slide a liner out of a section of pipe to see what it looks like. He also shows samples of cracked pipes so customers can see how the resin in the liner fills in cracks in the pipe. "Visuals are always key," he says. "It's the best way to show off your product."

In addition, Stefanidis provides customers with testimonials from satisfied clients as well as a list of references they can call. "We give them about 10 references and tell them to call three of them randomly," he explains. "That way they know they're not calling my mother or an uncle. ... They'll get an objective opinion of our performance."

Education is important because trenchless lateral rehabilitation is not always the cheapest route for customers to take. But if properly educated, customers more often than not are willing to pay a premium for pipe lining because it's so much more convenient and less intrusive. "Otherwise you have to dig a hole, fill the hole, let it settle for several months, then put more soil on and so forth," Stefanidis says. Moreover, digging up and replacing a line might require removing a tree or taking out part of a sidewalk, patio or driveway that later must be replaced. "So if you calculate the other benefits, then it's essentially cheaper to do it this way."

ADVERTISING PAYS DIVIDENDS

To get the word out on a larger scale, the company runs ads on a local radio station and pays for signage on the rear of city buses. The radio ads cost anywhere from \$750 to \$1,500 a month for seven 30-second spots in various time slots. The bus signs cost another \$800 to \$1,500 a month. The ads are a bit quirky and humorous, which helps brand the company in a friendly yet memorable way, Stefanidis explains.

"Advertising is not cheap, but it's something a business has to do," he points out. "We're the only ones in our market who do it. People tend to put more legitimacy on things mentioned on the radio or in print, so it made sense



Dennis Matthew (left) helps Mike Rodger get set up to shoot a liner into a 4-inch sewer lateral.

"Our philosophy is let's all work hard
for a good day's pay and
EVERYONE GOES HOME HAPPY."

Steve Stefanidis

in-house? Sure it does, he agrees. "But that's how partnerships are formed. In the future, you never know — we might amalgamate into Liner Guys Heating and Air Conditioning, or maybe add an electrical division, or a home-renovation division, or even get into project management.

"On the other hand, if you carry too many torches, you might lose one," he adds. "So for now, we plan to just focus on what we do best and do it right." **C**

to use these mediums to get more exposure."

When customers call for service, they're asked where they heard about the company; that enables Stefanidis to monitor the ads' effectiveness. So far, so good; he estimates that the bus ads generate about 30 percent of the company's job leads while the radio ads trigger another 20 percent. The rest come from word-of-mouth referrals, he says.

Looking ahead, Stefanidis envisions more steady growth for Liner Guys, but he and Rodger are cautious about growing too fast — jeopardizing quality control and customer satisfaction. "It's easy to ruin your name that way," he says. "That's why we don't have 10 or 20 crews. We don't lack for work and we're going to keep growing, but in a controlled way."

While the company does provide other services, such as lateral cleaning, pipeline inspections and line location, lateral lining generates the bulk of its revenue. But Stefanidis is not concerned about overdependence on pipe lining. He believes that as long as the company continues to provide top-notch customer service, there's enough work available to negate the need to diversify.

"We also pride ourselves on our ability to source things out for customers," he says. "I have contacts for electricians and carpenters, for example. I can supply almost anything they need." But doesn't that give other contractors revenue that Liner Guys could keep

more info

LMK Technologies
815/433-1275
www.lmktechnologies.com

Picote Solutions
219/440-1404
www.picotesolutions.com
(See ad page 28)

RIDGID
800/769-7743
www.ridgid.com
(See ad page 9)

SOUTHLAND TOOL MFG. INC.

Building Innovative Tools for Municipalities



SOLUTIONS TO SEWER CLEANING THROUGH:

- **CONCEPT**
- **DESIGN**
- **PRODUCTION**

Manhole Tools • Debris Baskets • Vac-Traps • Root Saws
Calcium Cutters • Sewer Rods • Handy Clams
Nozzle Extensions • Deep Vac Tube Holder
Grabbers Claws and Hooks • Diamond Tap Cutters
Fiberglass Poles • Hydraulic Cutters • Top Manhole Rollers
Sewer Spoons • Continuous Rod • Carbide Saws



1430 N. Hundley St
Anaheim, CA 92806

ph: 714.632.8198
fax: 714.632.8228

www.SouthlandTool.com



THIS DRUM CAN'T BE BEAT!

Model D-5

The rugged Electric Eel Model D-5 drain and sewer cleaner combines professional quality and affordability in a continuous cable drum machine for cleaning 3" -10" diameter lines up to 100 ft.

The high density polyethylene drum and belt guard will not rust or dent and holds up to 100 ft. of 3/4" diameter Tri-Max cable. Three sealed heavy-duty ball bearings support the drum and a thick wall guide tube extends wear. The D-5 is powered by a heavy-duty 1/2 H.P. capacitor-type motor to provide more torque, and the power feed and drum can be quickly removed.

Additional features include: Large 10" solid wheels for easy maneuvering and stabilization while in operation; extra strength 1-1/4" steel tubing framework; 5 position height adjustment on handle; wheel brake; continuous belt skirts and loading wheel built-in to handle; GFCI on 20 ft. line cord; and an air operated foot switch for easy operation. **Contact us today! Find out more about why the D-5 is the drum that can't be beat!**



Electric Eel® 1-800-833-1212
www.electriceel.com

DRAIN CLEANING TOOLS FOR PROFESSIONALS

LAPLACE EQUIPMENT

RENTALS, SALES & SERVICE

- **WATERBLASTERS:**
PRESSURE TO 40K,
FLOW TO 100 GPM
- WATER JETTING TOOLS
- HYDRO-MOWERS
- 3D NOZZLES
- ROTATING NOZZLES
- HIGH PRESSURE HOSES
- LANCES
- FITTINGS
- TIPS
- SUPPLIES
- EXPERIENCED TEAM FOR PLANNING, TRAINING & SETUP

CALL
985.652.5210
FOR YOUR
WATERBLAST
PROJECT
SOLUTIONS
WWW.H2OBLAST.COM

Petersen® Pipe Plugging Systems



Pipe Plugs and Packers for all your Pressure, Chemical, and Temperature Requirements. Call us to quickly customize a pipe plug or plugging system for your specific application.

Economical Hot Tap Plugging Systems

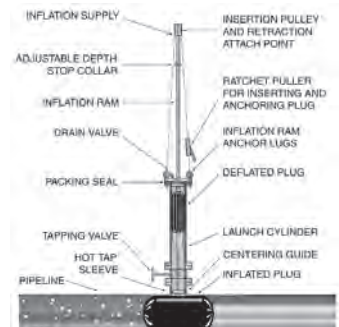

www.pipeplug.com

Petersen PRODUCTS COMPANY
Serving Professionals Since 1916

PHONE 800.769.4973 OR 262.692.2416
FAX 800.669.1434 OR 262.692.2418

Our technology pushes the industry *forward.*



INTRODUCING

NANO

While the NANO® is capable of traveling in pipelines as small as 2" in diameter, you will not be giving up power or flexibility. The NANO® has many of the same features of the larger ORION Zoom including: laser measurement, integrated location transmitter, bright LED lights, pressure regulation and full pan and tilt functionality. Use this amazing camera on your pushrod, tractor or lateral launch system!



(800)-656-4225 | www.rapidview.com



WHY DO LESS WHEN YOU CAN **ACHIEVE** SO MUCH MORE?

Picote Coating System A simple way to renew small diameter drains



Locate your reseller at picotesolutions.com or call 219 440 1404 for further information.

NEW: Picote Worldwide Training Center now open in Anderson, SC.

THE SMART CUTTER™



PRODUCT OF THE YEAR 2012

THE CABLE CENTER 1-800-257-7209

**MIDWEST'S LARGEST FACTORY AUTHORIZED
REPAIR CENTER FOR GATORCAM, GEN-EYE & SEESNAKE**

**24
HOUR
TURNAROUND**

**FREE
FREIGHT
ON ALL RIDGID
CAMERA
KITS**

RIDGID's CS10 Digital Recording Monitor

- USB Thumb Drive
- 12.1" Daylight Readable Display
- Multi Mode Recording
take snapshots, record full video & lean video
- Software Integrations
with SeeSnake HQ & RIDGIDConnect™



**CALL FOR
SPECIAL
PRICING ON
ALL CAMERA
KITS!**

THE CABLE CENTER · 8318 OLIVE BLVD. · ST. LOUIS, MO 63132 · 314-993-3099 · www.thecablecenterinc.com

When jet/vac versatility counts, count on a proven performer

No other jet/vac combination sewer cleaner can compare with the proven performance advantages of Vacall's AllJetVac models, with reliable positive displacement power. More vacuum power up to 27" hg. More jetting power up to 120 gpm. Simplified operation. Lifetime warranties on aluminum water tanks and optional galvanized debris tanks. Standard AllSmartFlow smart controls. Single-engine savings on fuel, maintenance and emissions. And host of options including a new water recycling system. Best of all, each model is designed, built and supported with legendary Gradall quality.

Call 800-382-8302 to learn why nothing works like a Vacall.



GREEN
THAT WORKS

AllJetVac

 **NEW**
Water Recycling Option

POSITIVE SOLUTION



VACALL.COM/AJV

 **ALAMO GROUP**

 **GRADALL**
INDUSTRIES, INC.
Where Ingenuity Works

Remote Patrol

Portable camera system reaches pipes in places typical CCTV trucks would dare not venture

By Ken Wysocky

As much as Hydro-Klean employees rely on the company's 16 CCTV camera trucks and trailers to perform mainline sewer inspections, there are times when technicians have to make like a light-hitting baseball team and play small ball.

That's where the CUBE portable mainline camera inspection system, made by R.S. Technical Services, steps in. Purchased in 2011, the small unit helps technicians inspect pipelines located in easements and other hard-to-access locations, says Matt Deutsch, chief operating officer of the company. Based in Des Moines, Iowa, Hydro-Klean does both municipal work (cleaning, inspection and CIPP lining) and industrial cleaning (vacuum work and hydroblasting).

"We do a lot of remote jobs where it's not easy to go and make a repair," Deutsch explains. "Or we work in sensitive areas where we can't get a camera truck in because of the ground conditions, or we inspect sewers along bike paths with a very thin asphalt overlay that's not designed to handle truck traffic.

"But the CUBE system fits on the back of our John Deere Gator," he continues. "It's like having a big camera truck on the back of an all-terrain vehicle. It's self-contained — everything we need in one small package. We just grab the CUBE and we're ready to go." Deutsch also praises the Gator's capabilities. "It can go just about anywhere — across farm fields and pastures and up different grades and elevations that a truck couldn't get through," he says.

The CUBE can carry up to 1,500 feet of camera cable and features a self-contained, onboard generator and MPEG video-recording capability. "We can save inspection videos right onto thumb drives and hand them to customers at the end of the day," Deutsch says. Housed inside a 1/4-inch-thick, powder-coated and glare-resistant aluminum body, the unit also offers two 500-pound-capacity storage drawers, a high-resolution color monitor and a front-access, 9-gallon pressure washer.

The CUBE also provides Deutsch with something equally valuable: reliability. "Uptime is a No. 1 concern for us," Deutsch explains. "Uptime is the reason we're able to keep our doors open for business ... and we've had no major issues at all with the CUBE.



Hydro-Klean operator Hans Nissen gets ready to launch the camera while foreman Zack Myers handles the controls of the CUBE portable mainline inspection system from R.S. Technical Services. The CUBE system allows Hydro-Klean employees to inspect sewer lines in remote and limited-space situations.

money machines

OWNER: Hydro-Klean LLC, Des Moines, Iowa

MACHINE: CUBE portable pipeline inspection camera system

FUNCTION: Inspecting mainline sewers and other pipelines

FEATURES: Capable of carrying up to 1,500 feet of camera cable; self-contained, onboard generator; MPEG video-recording capability; high-resolution color monitor; 1/4-inch-thick, powder-coated and glare-resistant aluminum body; two 500-pound-capacity storage drawers; a front-access, 9-gallon pressure washer

COST: About \$62,000

WEBSITE: www.hydro-klean.com

"If we're down, we incur the costs associated with that and customers are unhappy," he adds. "Moreover, there are times when we work in concert with other contractors who can't do their piece of the puzzle until we do our piece.

In those cases, downtime has a domino effect. You don't want to be that guy."

Downtime also hurts Hydro-Klean more than some other companies because it pays its employees overtime after they put in an eight-hour day, not after they accumulate a total of 40 hours for the week. "So if they're out there for more than eight-hours because of a breakdown, we're basically eating that time — we can't bill customers for it," he notes. "So uptime is absolutely critical to us."

The CUBE also helps technicians maximize productivity, thanks to its ability to maneuver in tight spots, such as inside manufacturing facilities, or more easily gain access to off-road manholes, for example. That helps crews achieve their feet-per-day inspection goals, Deutsch says.

For one project — inspecting and cleaning a mainline sewer — Hydro-Klean crews were able to work in residents' backyards. In another instance, Hydro-Klean technicians drove the CUBE right through the middle of an acres-big agricultural-manufacturing plant to inspect drainlines.

"It's like having a big camera truck on the back of an all-terrain vehicle. It's self-contained — everything we need in one small package. We just grab the CUBE and we're ready to go."

Matt Deutsch

"The CUBE gives us a way to solve problems like that," Deutsch notes. "The alternative is to drag a bunch of cable around, and sometimes the places we have to go are too far away for even that. And despite its size, we still get the same quality (images) as a big camera truck."

The Gator and the CUBE usually travel on a flatbed trailer, but Deutsch points out his crews have also transported the CUBE in the bed of a pickup truck. They use a forklift to get it onto the Gator or into a pickup truck — the unit features openings that accommodate a forklift's forks.

Training employees to use the CUBE is easy because it operates much like the company's other full-size camera trucks, outfitted by RST, CUES, Aries Industries, RapidView IBAK and Pearpoint. In addition, the CUBE is compatible with all eight of the various RST pipeline inspection cameras the company owns. Furthermore, the CUBE also serves as a marketing tool. Word gets around when a company can handle tough jobs, and Deutsch says he periodically gets calls from customers who've heard about the CUBE's capabilities and reputation as a get-it-done machine.

At a cost of roughly \$62,000, the CUBE represents a sizable investment. "Sure, the up-front cost looks expensive," Deutsch concedes. "But the expense is easier to swallow if you know that it'll allow you to do projects you otherwise wouldn't be able to do.

"The CUBE enables us to do jobs we normally couldn't complete with conventional sewer line inspection equipment," he says. "It allows us to go after the tough jobs — and those are the ones we want. We want to be the company that solves problems other providers can't, and the CUBE helps us do that." **C**

go ahead... take a Quick Peek

DRAINLINE INSPECTION SYSTEM

- ✓ Inspect 2"-10" diameter lines up to 300' in length
- ✓ High resolution, low lux self-levelling color camera
- ✓ Fully locatable with 512Hz in-line transmitter
- ✓ 7" LCD monitor with protective sunshield
- ✓ AC/DC input
- ✓ Keyboard for annotation
- ✓ Video/Audio output
- ✓ Microphone
- ✓ Battery power option

**Want a field demo or more info
on the Quick Peek System?
Call or visit us online today.**

RST Technical Services Inc.
Design and Manufacture of Video Pipeline Inspection Systems



SMALL DIAMETER PIPE INSPECTION

1800.767.1974

www.rstechserv.com

WHY BUY FORBEST

- Our products are the most easy devices to use and record with both USB and SD cards;
- Our products are reliable and the most affordable;
- We offer the lowest service cost and the shortest turn-around.

Economic Inspection Camera System

FB-PIC3188SD

\$550

Specs:

- 7" Color LCD Control Station with SD Card Recorder
- 1" Color Camera Head with 512HZ Built-in Sonde for Option
- 65'/100'/130' Cable Reel Available for Choice
- Heavy-duty Waterproof Case



Layflat Pipe Inspection Camera

FB-PIC3588A/3588BT

- 7" LCD Control Station with Built-in USB Flash and SD Card Recorders and Li-Ion Battery
- 3/8" 150' /200' Cable & Reel w/Electronic Meter Counter
- Crawler for easier push
- 7/8" Stainless Steel Color Camera Head w/Built-in 512HZ Sonde Transmitter for 3588A (1.5" Self-leveling Head w/ Built-in 512HZ Sonde Transmitter for 3588BT)



Mini Self-leveling Color Camera Head

CHD-C26/CHDT-C26



- 1" Mini Self-leveling Color Camera Head
- 512 HZ Built-in Sonde Transmitter for Option
- Compatible with All Forbest Cable Reel and Control Station

Potable Color Sewer/Drain Camera

FB-PIC3188A/3188DN

Specs:

- 65'/100'/130' Cable & Reel
- Color Camera Head
- 7" LCD Monitor w/ w/o DVR & MIC
- Heavy Duty Waterproof Case
- Option 1: upgrade to Color Camera Head w/ Built-in 512HZ Sonde Transmitter
- Option 2: upgrade to 130' Cable & Reel w/Meter Counter



Mid-Range Pipe Inspection Camera

FB-PIC3388UT/3388MT

- 200' Cable & Reel w or w/o Meter Counter
- Self-leveling Camera Head w/Built-in 512HZ Sonde Transmitter
- 10" LCD Monitor w/DVR & MIC
- Recording with USB Flash Drive or SD Card
- Heavy-duty Waterproof Case
- Crawler for easier push



FB-R2012

Specs:

- Frequency: 512HZ
- Operation Mode: NORM/NOISE CONTROL
- Power Supply: 6*AA
- Current: < 55mA
- Sensitivity: NEAR/FAR
- Continuous Adjustable
- Output Intensity: LCD 15 Levels
- Retractable Poles for Easy Use

512HZ Locator

NEW



Promo Price: **\$499**

Luxury Portable Sewer/Drain Camera

FB-PIC4188M/4188H

Specs:

- 130' Cable & Reel w or w/o Meter Counter
- Color Camera Head w/Built-in 512HZ Sonde Transmitter
- 10" LCD Monitor w/DVR & MIC
- Recording with USB Flash Drive & SD Card
- Heavy-duty Waterproof Case



Long Range Pipe Inspection Camera

FB-PIC3288T/3488T

- 300'/400' Cable & Reel w/Meter Counter
- Self-leveling Camera Head w/ Built-in 512HZ Sonde Transmitter
- 10" LCD Monitor w/DVR & MIC
- Recording with USB Flash Drive or SD Card
- Heavy-duty Waterproof Case
- Crawler for easier push



US: 44130 Old Warm Springs Blvd. Fremont, CA 94538 Tel: 510 226 7988 Toll Free: 1 877 369 1199

www.forbestusa.net

Canada: 9040 Leslie St. Unit 1, Richmond Hill, ON L4B 3M4 Tel: 905 709 6226 Toll Free: 1 877 369 1199

Email: forbestusa@gmail.com

Inside The Pipe "GRIPPER" Tool



Easy To Use Pneumatic Tool For Grabbing Objects in Sewers & Ventilation systems

- Makes 90° Bend in 4" Pipe
- Air Powered (15psi) Operation up to 82' Standard or Longer Distances Possible (Option)
- Fast & Simple Maintenance
- "No" detection needed
- Camera Hook Up Optional
- Easy In/Out using Fiberglass Push Rods, Cable or Sectional Rods
- 2.16" dia. x 9.45" length - Weight 10#
- Pliers Teeth Grabbers Optional

Cost \$2400.00 + Freight

CLOVERLEAF Tool Co.®

"Quality Products at Affordable Prices"
P. O. Box 110757 • Bradenton, Florida 34211 USA
Toll Free: 800-365-6583
Tel: 941-739-0707 • Fax: 941-739-0001
www.cloverleaftool.com • email: sales@cloverleaftool.com



CUSTOM DRILLED NOZZLES

SIX PACK KIT™



NOW OFFERING JETTING HOSE! CALL FOR A QUOTE

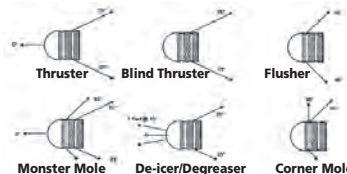

NPT Size	Price	Savings*
1/8"	\$224	\$37
1/4"	\$254	\$44
3/8"	\$294	\$52
1/2"	\$373	\$67

*Compared to individual prices

• Each nozzle is **custom drilled** to match your pump's flow and pressure specs for **optimized nozzle performance**.

• Custom drilling means **your choice of spray patterns**.

• Each nozzle is made with **heat treated 416 stainless steel** for superior corrosion and wear resistance, and rated up to 10,000 psi.

• Most orders shipped within **one business day**.

• **100% satisfaction guarantee**.

CALL TOLL FREE: 877-457-2782

North Royalton, OH 44133 • www.aquamole.com • Fax: 440-237-2987

877-901-1936

THE NEW

**BRUTE
JETTING**

www.jettersonorthwest.com
SYSTEM

BY

JETTERS NORTHWEST

ALL-IN-ONE

MOUNTABLE-SKID



PORTABLE-CART



CHOOSE:

12 GPM 3000 PSI or 9 GPM 4000 PSI

**BRUTE POWER...BRUTE
PERFORMANCE...NEW VERSATILITY!**

www.Jettersonorthwest.com

2222 15th Avenue West Seattle, WA 98119

BY MARIAN BOND
PHOTOGRAPHY BY AMY VOIGT

STARRING IN A SUPPORT ROLE

SEWER AND DRAIN CLEANING COMPANY BUILDS ITS REPUTATION
AS AN EXTENSION OF THE LOCAL PLUMBING INDUSTRY

**RICHARD AND MILLIE GOAN LAUNCHED
PLUMBER'S SERVICE IN 1955 WITH A UNIQUE VISION.**

“They wanted to create this partnership where the plumber would be represented by a high-quality and noncompetitive extension of their business,” says Jeff Goan, who took over his parents’ business in 1994. “Even today, at least 50 percent of our business is with plumbing contractors. We work closely with them and we are there when they need us, 24 hours a day, seven days a week.



Plumber's Service owner Jeff Goan on a job site in Grosse Pointe, Michigan.

We do not advertise. There are no wraps on our trucks. When we go out for ‘Bob’s Plumbing,’ for the most part the customer thinks we are ‘Bob’s Plumbing.’ We are a bit of an anomaly.”

Goan points out that most plumbing trucks are filled to the brim with tools and fixtures. Drain cleaning vans are just as full with their own specific equipment, so to be fully equipped to do it all, it would take a semi. Instead, Plumber’s Service focuses on sewer and drain cleaning and rehabilitation, and lets plumbers focus on what they do best. The result is greater specialization on both sides and better work all the way around.

While the company maintains its focus on serving plumbing contractors, the customer base has grown along with the company’s reputation. Plumber’s Service now serves property management companies, mechanical contractors and even a few municipalities. The company doesn’t advertise, so the occasional residential client comes on the referral of a relative, neighbor or friend.

“We provide good customer service and follow-up,” says Goan. “If our service technician finds any problems, we will follow up with the plumbing contractor to see if they want us to proceed to do any continued maintenance, or structural lining or cable maintenance. We offer a number of options for their client.”

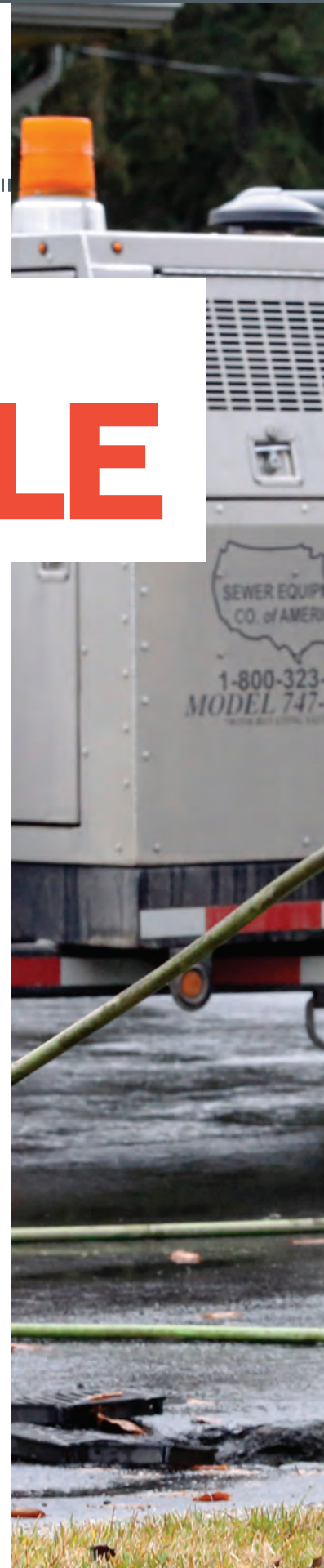

Plumber's Service technicians Jim Simpson (left) and Brandon Myre feed jetter hose in through a clean-out while working to unclog a lateral line.



profile

PLUMBER'S SERVICE

SERVING THE GREATER DETROIT AREA

OWNER: Jeff Goan

YEARS IN BUSINESS: 61

CUSTOMER BASE: Plumbing companies, property management firms, residential and HVAC mechanical contractors

SERVICES: Sewer and drain cleaning, jetting, leak detection, radio detection, pipe bursting and structural pipe lining

EMPLOYEES: 20





Plumber's Service owner Jeff Goan (center) speaks with Rick Dube, owner of Rick Dube Plumbing in Detroit, as Goan's crew sets up to clear a lateral line for one of Dube's customers.

THE FAMILY CONNECTION

Jeff Goan is the owner of Plumber's Service, but he's not the only one with an important role in the company and family ties to its founders.

Jeff's brother, Jim Goan, has been a part of this company for many years, handling human resources, payroll, insurance, and tax and regulation issues. He also serves as a sounding board and adviser.

"My brother is a business backbone for me, as he keeps me on point, and with an MBA in business he has much to contribute," Goan says. "He also has experience working in the lines over the years and while attending college, and in his off hours while he was working in the health care industry for several years."

Jim Goan says he tries to be someone his brother can consult with on the major issues and stressful situations that arise in any business.

On the subject of finding qualified technicians, the brothers agree it is one of the biggest challenges. Jeff Goan says that young people are just not going into the trades. He finds their best employees are those who tried to make it in other fields until they realize that they are in a job with no real future or opportunity to make enough to support a family.

"We look for a guy with the qualities we want, someone who wants to be successful, someone who wants to learn everything we can teach," Goan says. "It can take time to get the expertise where a person can do a lot of this work in a confident manner. We want our customer to have confidence in our technician to handle the problem."

Working with and for plumbing companies, especially as a primary revenue source, calls for an arrangement when it comes to collecting and billing. Goan says their process is flexible. Sometimes the plumbing contractor will provide invoices to Plumber's Service, and they will handle the transaction. Other times they will do the work, and the customer will pay the plumbing company directly through their billing.

"We have our standard rates for our services, but with the plumbers we give a commission for work we do for them, so they actually get better pricing."

They promote the company through direct mail to plumbing contractors in their service area, which includes a 50-mile radius around the greater Detroit region. If they are required to go beyond that area, they charge extra for travel.

GETTING WITH THE PROGRAM

Goan says that his father was a visionary who was open to new technology as it came along, using some of the early locating equipment to trace the paths of buried lines.

"This had always been a challenge to precisely locate the damaged areas," he says. "We got into televising lines in the 1980s. Pipe bursting came along in 2000, and structural lining around 2005."

Plumber's Service has added jetting, radio detection and confined space entry, but they continue with excavation when necessary. The company has a dual-reel trailer jetter (3,000 psi/40 gpm) from Sewer Equipment, and contracts with several firms when a jet/vac truck is needed for cleaning catch basins, oil interceptors or industrial waste



Jeff Goan (left) speaks with cable dispatcher Sheri House about a customer while Leah Wills works on invoices at the company headquarters in Milford, Michigan.

handling and disposal. They have a variety of Pearpoint/SPX and Vivax-Metrotech cameras in their inspection arsenal.

“Conditions in the area are typical of older neighborhoods, with Orangeburg (pipe) that is often failing, and clay pipe that isn’t watertight and allows root intrusion at the joints,” Goan says. “Then we have cast iron pipe, which deteriorates and rusts out. These all offer opportunities for our services. We find Orangeburg (pipe) can be repaired with pipe bursting and sometimes relining.”

“I CARE ABOUT THESE PEOPLE.

If they are struggling personally or financially we try to be helpful, and I think we deal even-handedly. If there is a problem, I’ll pull an individual aside and work to solve the issue.”

Jeff Goan

He says the Formadrain structural lining and Pipe Genie pipe bursting systems have been successful in clay and cast iron pipes as well.

Goan has 14 technicians who typically work on either the “dig crew” or the “cable crew.” They are specialists, but they are also cross-trained for any situation that requires their services. The dig crew takes care of televising, jetting, pipe bursting and excavation work. The cable crew is appropriately equipped with all the cable equipment.

“They snake the line, cable it, get it open using a full diameter cutter and they are taught to restore a 6-inch pipeline back to 6 inches,” Goan says. “Some customers request a yearly service call to keep the lines open.”

The Formula for Success is Simple.

- Hire good people.
- Take care of your customers.
- Buy the best equipment.

Industry leaders prefer Cat Pumps, the most reliable, longest-lasting pump.

Model 3550
Rated to 10 gpm and 6,000 psi

When it has to run, make it Cat Pumps.

www.catpumps.com
(763) 780-5440 | info@catpumps.com

© 2015 Cat Pumps All Rights Reserved. 15429 12/15



Jim Simpson unspools hose from a trailer-mounted Sewer Equipment jetter while setting up for a cleaning job in Grosse Pointe, Michigan.

“I WANT EVERYONE TO REALIZE THAT WE OFFER AN IMPORTANT PRODUCT AND THEY SHOULD FEEL GOOD ABOUT THE JOB.

We can have a nice level of satisfaction because we are solving a problem that is important for our customer, both the plumber and the homeowner or business.”

Jeff Goan

Goan has a lot of confidence in these two crews to perform their duties, and he values open working relationships with his employees.

“Ultimately, decision-making that affects the company on a bigger scale comes down to me,” he says. “Day to day I can depend on my crew members to handle their chores. On the dig crew I have 20-year employee Danny Harris, and on the cable crew I have another longtime employee George Cissney. They are always available to their crews when they need advice. I am only brought in for consultation when required.

“I care about these people,” Goan says. “If they are struggling personally or financially we try to be helpful, and I think we deal even-handedly. If there is a problem, I’ll pull an individual aside and work to solve the issue.

“I want everyone to realize that we offer an important product and they should feel good about the job. We can have a nice level of satisfaction because we are solving a problem that is important for our customer, both the plumber and the homeowner or business.

“Yes, the guys get frustrated sometimes, but we look for the person with the qualities we want, someone who will stick with us and wants to be successful in this line of work. Someone willing to learn everything we can teach. It takes a lot of time to get that expertise where an individual can work in a confident manner.”

Goan points out that they offer good benefits that include health insurance for their 20 employees, plus vision and dental, a 401(k) plan and vacation pay.

TAPPING INTO THE TASK

Goan says they start each day at the company’s headquarters — a 6-acre property with offices and two buildings for equipment — by gathering to review the day’s jobs and assignments.

“When I come in each morning I like for the guys to get together, deciding who goes where and does what and how it gets distributed, and I participate,” he says. “We figure what customers need to be contacted from the previous day’s work. As for myself, I’ll have appointments my office staff will have lined up. A plumber might be having an issue on a specific job and want me to consult. I will go to that job, take a camera with me and decide what we want to do. That kind of thing is a part of my day-to-day activities.

“Whenever I bring on new equipment, I’m always in the field with my crew, training them on it — teaching how to do it, going through the hard

Flexible and Affordable Financing Options



Financing for New and Used Equipment

Trucks • Tanks • Trailers • Toilets • Cameras • Jetters
Computer Hardware & Software



LIBERTY FINANCIAL
A DIVISION OF NAVITAS LEASE CORP.

7 Church Road, Hatfield, PA 19440
Phone: 800.422.1844
Fax: 888.883.9380
Visit our website: www.libertyfg.com

Call Michael DeGroat (ext 112)

Commercial Equipment Financing Call 800-422-1844

knocks of learning how to pipe burst and any related problems, going through harder knocks on how to do CIPP and how to avoid tragedies. I want to have a confident staff of guys who can get the job done without me there. We will still review the job together, but I like it when I can get to the point where I can confidently give them a bursting or lining job. I like to train with them, get them comfortable. I like that part of the job."

He says that early on his workers were apprehensive about lining because they were used to bringing in a machine and digging it up, but as they got more comfortable with the Formadrain system they understood the value it brought to their own work and to the customer.

"Pipe bursting is complicated. Lining is complex," Goan says. "It takes a mechanical person. But we want to give our customers another choice. I like having an option that avoids the excavation work, as it has a dramatic impact on the property, and most important, my guys are on the surface and not in a trench line or a trench box." c

more info

Formadrain, Inc.
888/337-6764
www.formadrain.com

Pearpoint/SPX
800/688-8094
www.pearpoint.com

Pipe Genie Manufacturing
877/411-7473
www.pipegenie.com

Sewer Equipment
877/735-4640
www.sewerequipment.com

Vivax-Metrotech Corp.
800/446-3392
www.vivax-metrotech.com
(See ad page 16)

One Stop Shopping for Your Trenchless Needs!

24/7 Support / Free Training



Cured in Place Pipe
- Quik Shot 3"-8" Lateral Lining
- Try Tek CWP 6"-18" Mainline Lining
- Ambient, Hot Water or Steam Cure Available
- Epoxy, Silicate, or Polyester Resins



Try Tek Robotic Cutters
- Trydent 80 Cutter 3-6" Lines
- Legacy Cutter 6-15"



NozTeq Sewer Cleaning Nozzles & Root Cutters
- Lumberjack - Predator Series



PrimeLiner Sectional Lining Equipment & Supplies
- Materials sold in Bulk
- Pipe Repair Kits available



Cherne PipeLine Plugs & Testing Equipment
- Test Balls/Muni-Balls - Air Testing
- Smoke Testing



Epoxytec Manhole/Wetwell Rehabilitation
- DIY Products - CPP - Uroflex



Trelleborg/NPC Pipe Seals
- Internal Joint Seals - Liner End Seals
- External Joint Seals - Chimney Seals



DeNeef Chemical Grouting
- Mainline Grouting - Wellpoint Grouting
- Sealing underground Structures

www.PrimeLineProducts.com
877-409-7888 407-772-8131

SHAKE, RATTLE & ROLL through the toughest jobs

with enz[®] Rotopuls Vibration Nozzles

Pipe diameter range: 1.5" - 4"



For removal of medium to hard deposits
in plastic, steel or concrete pipes

- Ideal for waterless urinal 2-3" pipes
- Small size allows for navigating tough bends
- Provides hard vibration impact
- Used to clean waterless urinals in the Smithsonian



CALL 1 877 ENZUSA1
For a dealer near you
www.enzusainc.com



1585 Beverly Ct., Unit 115 | Aurora, IL 60502

YOUR SOURCE FOR RIDGID



CS6 Digital
Recording
Monitor



CS10 Digital
Recording Monitor
with Flash Drive



LT1000 Laptop
Interface System



SeeSnake[®]
Compact 2
Camera
Reel



SeeSnake[®] MAX rM200
Camera System



DVDPak



microDrain Reel

CENTRAL OKLAHOMA

Winnelson

COMPANY

8% ONE YEAR FINANCING AVAILABLE!
Longer lease rates also available. Call Keith for details.

BUYING A SEESNAKE?

**CALL US FOR
GREAT PRICING &
FREE SHIPPING!**

**WE
WILL NOT BE
UNDERSOLD**

- Call Us Evenings and Weekends -

Keith: 405-602-9155 &

Jim: 405-205-3974

CALL TOLL FREE: **888-947-8761**

5037 NW 10th
Oklahoma City, OK 73127

www.centralwinnelson.com

Parts, Parts, & More Parts



Direct to You.

When you need parts in a hurry there is one source to remember – FS SOLUTIONS®. FS Solutions centers stock thousands of parts for all makes and models of vacuum trucks, waterblasting equipment and hydro-excavators. And FS SOLUTIONS is the authorized genuine OEM parts distributor for JETSTREAM®, GUZZLER®, and VACTOR® HXX®.

Parts are available at nationwide locations for pick up or quick shipment.



A proud member of the Federal Signal Family.

FS Solutions® Vactor® HXX® Jetstream® and Guzzler® are registered trademarks of Federal Signal.

www.fssolutionsgroup.com 1.800.822.8785

© 2015 Federal Signal Corporation

Two for One

Jetstream's TwinForce waterblasting system handles any job, big or small

By Kyle Rogers

Today's high-flow cleaning nozzles require some serious horsepower. Yet not every job needs a great deal of flow. Enter the TwinForce dual-pump waterblasting system from Jetstream, a subsidiary of Federal Signal Corporation.

The system can provide 650 hp for high-flow applications, but because that power is provided by separate 325 hp engines, it is also a good fit for smaller jobs. Jetstream displayed the TwinForce at the 2016 Water & Wastewater Equipment, Treatment & Transport Show.

"There's a remote manifold at the end, so you can have 650 hp or you can have two 325 hp completely independent units," says Jetstream engineer Eric Rust. "That's a huge benefit. Someone taking on a huge cleaning job can use all 650 hp, and then if they follow with a smaller job, they can split the units apart."

The system, which has been on the market for almost two years, uses all of Jetstream's standard components. It just doubles them.

"The name is of course the TwinForce because there is two of everything, packaged as one," Rust says.

The system is built around Jetstream's UNx fluid end, designed for easy servicing and fast conversion between operating pressures of 8,000 psi up to 40,000 psi. Dual fuel tanks provide eight hours of runtime between refuelings.

Rust says Jetstream developed the dual system primarily to serve industry trends. Instead of manually handling a cleaning tool, more of Jetstream's customers are turning to automation. That creates an opportunity to do higher-flow applications, but achieving such flow also requires more horsepower.

"When using a tool, there's a lot of thrust and 325 hp is basically all a person can handle. But then you're limited to only so many gallons per minute," Rust says. "If you're going with automation, you can clean faster with more volume, but now you need the equipment that can run these big cleaning tools. If you have a tool that can produce 100 gpm, you need the horsepower to be able to get there."

When operating as one, the dual units can provide up to 125 gpm at 8,000 psi. With a single 325 hp unit, 62 gpm is the maximum flow at 8,000 psi.

Though the goal of achieving more total horsepower was the impetus behind developing the TwinForce, it is the system's versatility that has caught customers' attention, Rust says.



Richard Padilla, right, a regional sales manager with Jetstream, explains a few features of the TwinForce dual-pump waterblasting system to an attendee at the 2016 WWETT Show. (Photo by Craig Mandli)

"We didn't go into the market focusing on versatility," he says. "We went into the market saying, 'We need to be able to feed this tool 100 gpm. This is how we're going to do it.' But a lot of our customer feedback has been about the versatility. It's very unique that it is a dual setup. If I need to run a big cleaning tool that requires 100 gpm, I have that option. If I have a smaller job that only requires 30 gpm, I can run just one of the 325 hp units and not waste all the extra fuel and water. And if one of the engines or something on one of the pumps were to go down, I still have the ability to clean with the other unit. Maybe it's at a slower rate, but it's functioning and I'm still able to do my job. I don't have to wait to get another unit from the shop or have it repaired.

"Giving the system exposure to a whole bunch of people who didn't know it existed is the benefit of coming to this show." 800/231-8192; www.waterblast.com. **C**

The M30 Portable Gas Jetter



**Good on grease,
septic systems or
whatever the season
brings your way!**

The **M30** is suitable for 1½" - 6" lines,
and rejuvenating drain fields.

It delivers 4.5 GPM at 3000 PSI
measured at the nozzle, and is
effective on grease, sand, food,
paper products, and other soft
obstructions.

Components allow for jetting
indoors while the gas engine
remains outside.

MyTana is your ONE Source for
all the tools the sewer and drain
cleaning professional needs.
And personal customer service
to help you—in the shop
or in the field.

MyTana

1.800.328.8170
www.MyTana.com

 Made in the U.S.A.



*Request your FREE,
FULL LINE catalog today!*
1.800.328.8170



CABLE MACHINES – JETTERS – PUSH CAMERAS FOR MAIN LINES AND DRAIN LINES • LOCATORS • RELATED PARTS • ACCESSORIES
Factory Direct Customer Service Competent • Polite • Clear (M–F 7am - 5pm CST)

Pulsar 2000 Line Tracer

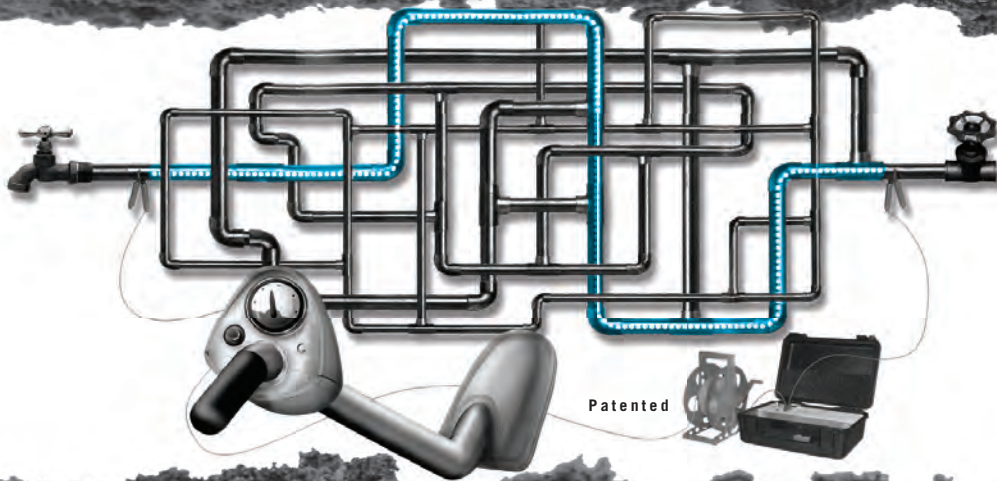

**Locate Lines
Locate Water Leaks
Training Video**

It's a jumble out there.

www.Pulsar2000.com
DISTRIBUTORS WANTED



The Pulsar 2000 line tracer is designed primarily to locate metallic pipes. The Pulsar 2000 is a directional line tracer. Connect the Pulsar's powerful and unique transmitter to your target pipe and locate only that pipe. Locating can be accomplished under floors, in walls and in ceilings. The Pulsar 2000 does not require grounding.

Leak detection personnel... The Pulsar 2000 is a must have locator. Now you can quickly identify the pipe location, thereby reducing the search area of the leak.

100% satisfaction guarantee... We are so sure that you will see the time saving benefit of the Pulsar 2000, we will let you return it for a full refund if you are not satisfied. If

you want to learn more about the Pulsar 2000 and our leak locating equipment, please call 1-888-752-5463 or e-mail jsml@aol.com for a free demonstration video or CD and references of satisfied customers.

We have been using the Pulsar 2000 along with the XL2 fluid detector and Geophones since January 1989 in our leak locating business. Our leak locates are **accurate 95% of the time**, but I can honestly say, the line we trace is always there. Our equipment is user-friendly and requires very little training, as you will see on the video. Purchase the Pulsar 2000 line tracer, XL2 fluid detector and Geophones, and start locating leaks immediately.

This Is The Nozzle You've Been Waiting For

^{*Patented}
Root Rat  **root cutter nozzle**

1/2"
7-35 gpm/1500-10,000 psi

3/8"
3-10 gpm/2000-7500 psi

3/4-1"
40-160 gpm/1500-4000 psi

Custom Built Jetters
Hot or cold water jetters from 4 gpm at 4000 psi to 12 gpm at 4000 psi, skid or cart frames or small trailer systems.

Root Rat Combo Kit
3/4" - 1" root rat combo kit. Use a reducer adapter to go from 1" to 3/4".

*"The Root Rat is the easiest and most versatile root cutter nozzle I have ever used. The Root Rat works where other nozzles fail."
Tim Jones, owner of Eastern Sewer Jetting*

MADE IN THE USA

WE SELL AND SERVICE COLD WATER JETTERS

We Sell Parts, Pumps, Unloaders, Hoses, Jet Tips, ETC.

Visa, Mastercard, Discover, AmEx Accepted

CHEMPURE PRODUCTS CORP.
1-800-288-7873 • 330.874.4300

www.rootrat.net

Down time is expensive.

DO YOU HAVE A SPARE CABLE IN THE TRUCK?



AFTERMARKET CONNECTORS • CABLES

ALL cables and connectors are individually inspected and tested before shipment.

REASONABLE PRICES

Seacon/Turck



OceanQuip LLC
ORCA TOUGH CABLES

504 738 7833 p/f • jfowler307@aol.com

www.OceanquipLLC.com



GORLITZ SEWER & DRAIN INC.

Norwalk Blvd. Santa Fe Springs, Ca. 90670

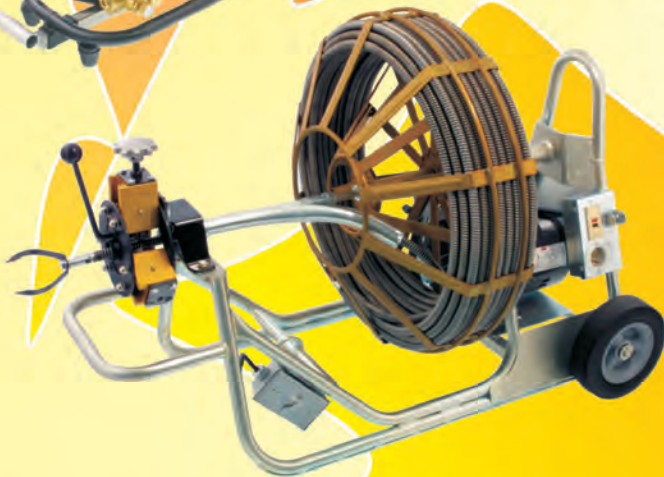
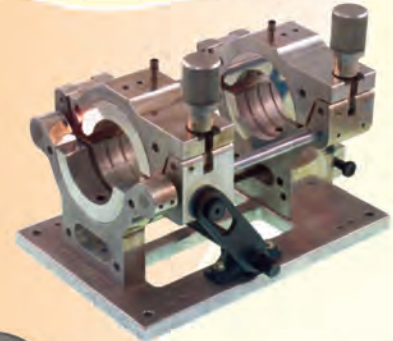

MACHINES
FEEDERS
CABLES
RAMPS
CONNECTORS
LEADERS
CHUCKS
ENDS
RETRIEVERS
SPLICES
AUGERS

—

JETTERS
NOZZLES
HOSES

—

TRENCHLESS
PIPE SYSTEMS

—

SOCKET
FUSION KITS

Engineering, Dedication, Quality, Sales and Service All In One Stop!

www.gorlitz.com
 Email: sales@gorlitz.com
 GORLITZ on Facebook



Tel: (562) 944-3060
 Fax: (562) 944-7630



Erik Gunn is a magazine writer and editor in Racine, Wisconsin.

Keep On Deducting

Now that a strong federal tax benefit for equipment purchases is permanent, it's time to think more strategically about machinery purchases

By Erik Gunn

There's some good news on the tax front for small companies that spend big bucks on equipment.

After more than a decade of year-to-year uncertainty, an important federal tax deduction on equipment purchases has been made permanent — part of the big federal tax and spending measure that Congress passed and the president signed late in 2015. The deduction is found in Section 179 of the U.S. tax code, and it lets small businesses take an immediate federal tax deduction on the price of certain kinds of new equipment in the year it's purchased.

YEARLY CLIFFHANGER

Back in the 20th century, Section 179 was a pretty small deal — you could only take it for equipment costing less than \$25,000, and you could only take the full deduction for a total of \$125,000 worth of equipment purchases in a year.

“What is the return on investment and payback period of the asset to be purchased? ... There may be a startup period where the machine is slowly eased into service over a period of months. As more clients discover your new equipment is available, the more the equipment will earn its keep.”

Randall Turner

In the economic slump that followed the 9/11 attacks, Congress gave Section 179 a temporary big boost, setting the cap at \$500,000 for individual pieces of equipment that can be expensed in the year they are placed into service. Congress also raised the cap for all equipment purchases in a year that would qualify for the full deduction up to \$2 million. In the nearly 15 years since then, the higher limits have been renewed every time they were about to expire. That's been an annual ritual for several years now.

The latest spending plan ends that annual ritual by making those higher limits permanent (or at least as permanent as anything gets in Washington). No more late-December cliffhangers about the future of Section 179.

“This is something truly directed at small businesses,” says Patricia Hintz, who practices tax law at the Milwaukee law firm of Quarles & Brady.

Here's how it works in practice:

Suppose in 2015 you bought a new specialized truck for \$100,000. Traditionally, a purchase like that has to be depreciated over a fixed period of time. That means you can't deduct the full cost the year you buy the vehicle — instead, you deduct a portion of the cost over several years, using a formula that also reflects its depreciating value.

FINANCIAL FLEXIBILITY

(Depending on a lot of factors, you might even want to stick with that approach. That's way beyond the scope of this column, though — and what we say here is no substitute for what your professional legal and financial advisers who know the details of your business circumstances can tell you.)

Section 179 allows you to take the full deduction in year one for that \$100,000 truck. By the way, you can take it no matter whether you're paying for the truck in full when you buy it or whether you finance the purchase so you're paying for it over several years. On the tax forms, the Section 179 deduction, if you take it, is for the full \$100,000.

That \$100,000 comes off the total taxable income of your business — or your own taxable income if your business, like most smaller firms, is organized as an S corporation or a limited liability corporation (LLC), with the income passing straight through to the owner.

“It takes your income down dollar for dollar,” Hintz says. “The actual effect to your taxes depends on what bracket you're in.”

To someone for whom the marginal tax bracket is 30 percent, “an additional \$100,000 deduction will reduce your tax bill by \$30,000,” she explains.

LIMITS AND COMPLICATIONS

If you spend more than \$2 million a year on equipment that qualifies for the Section 179 treatment, the tax break starts to phase out.

And the provision only applies to equipment; other kinds of expenses — such as real estate — don't qualify for the immediate deduction it offers.

There are some other wrinkles. First, you don't have to take the Section 179 deduction for the entire cost; if it's to your financial advantage to take only part of it and depreciate the rest of the cost over the next several years, you have that choice. Second, you *can't* benefit from the full deduction if your business reports a net loss for the year — or would if the full deduction was counted. But you can carry forward the deduction to future years so long as you claim it to start with.

But complexities like those are yet another reason you must work with your professional adviser before making any decision of this sort. (And if you're losing money or close to it, you have problems a whole lot bigger than how to best deduct the cost of a new truck on your taxes!)

35 YEARS

MULTIPLE INSPECTION SOLUTIONS,
ONE PROVIDER: RATECH.

Ratech now adds a wi-fi interface to its arsenal of innovation.

Always at the forefront in the development, manufacturing and servicing of CCTV systems and equipment, Ratech adds to the growing list of ways you can view and record CCTV video pipeline inspections with their NEW wi-fi interface. Safe, secure, and delivering on the promise of quality and durability industry professionals have demanded from Ratech for over three decades.

Elite SD or USB



Mini Crawler
with Pan n' Tilt



Pan n' Tilt Push Camera
(Includes Reel and Remote Control)



Ratech ELECTRONICS

Video Pipeline Inspection Systems

For more information on these or other products call toll free:
1-800-461-9200 or 905-660-7072 www.ratech-electronics.com

Upload your inspection videos to [YouTube](https://www.youtube.com) Ask us HOW?



THINKING STRATEGICALLY

With or without Section 179, there's another important lesson: Having the robust benefit can unquestionably provide a great help to your bottom line, but it's *never the reason* to make that purchase. You really need to take stock of what the purchase is going to be worth to your business, says Randall Turner, a financial consultant based in Bradford, Pennsylvania, with extensive experience in equipment-heavy industries.

Business owners will — and should — weigh several factors before buying a large asset, Turner explains: what they need vs. what they want, whether to buy new or used, how much they can afford, how they'll pay for it and whether it's the best use of their money.

But then there's "the most unexplored question that really should be the first question," he adds: "What is the return on investment and payback period of the asset to be purchased?"

That requires carefully considering what the real revenue of the new machinery will be — and what it really costs to run it.

"There may be a startup period where the machine is slowly eased into service over a period of months," Turner says. "As more clients discover your new equipment is available, the more the equipment will earn its keep." Or on the flip side, the equipment might go into use at a time of rapidly expanding demand and get put to use overtime right away — only to suddenly go unused after the initial burst of excitement once pent-up demand is exhausted.

So consider the full cost over time — payments, fuel and maintenance, and labor to operate the machine — in your ROI calculation.

"Then the simple test is to compare the expected ROI with how much

return you'd expect to get in an alternative investment with similar risk," Turner says. You need to consider the cash-flow payback over time to see when you start breaking even.

Subtracting costs from the annual revenue, then multiplying by 100, will give you an ROI as a percentage. And you'll need to chart that year to year to determine when you'll break even and start profiting from the machine.

CHANGING TIMES

The world is changing too fast to simply assume a perpetual status quo, Turner points out. "Everyone thinks the world's going to stay like it is," says Turner. "How stable is your market?"

He's seeing banks close their fists now — "looking for excuses not to loan money." That means any purchase should be accompanied by a solid financial prospectus for the acquisition.

And for that reason, even just relying on a standard replacement cycle isn't necessarily the right move. Instead of planning a replacement cycle of five or seven years, "I would look at it every year because every year your environment changes," Turner says.

So where does that leave you? The bottom line is you now have a reliable, robust tax break to count on when buying new equipment. But more than ever, changing circumstances will require you to undertake a careful analysis of equipment needs and your ability to support the purchase for the long term.

And that will be worth a lot more than any tax break, no matter how generous. **c**

Cleaner is FREE! Subscribe online at www.cleaner.com



Professional Grade Equipment



ProVac

Industrial Pumpout System

Ideal For Grease Trap Service



PRO-CHOCK

TRANSPORT HOLD DOWN

Quick & Easy

A Must Have Accessory

www.westmoorltd.com

Westmoor Ltd., 906 West Hamilton Ave, Sherrill, NY 13461

TEL (800) 367-0972



Pressure Washers and Drain Jetting Equipment



Skid and
truck mount
models up
to 7000 psi



Portable Hot
and Cold Water
Diesel Powered Models



Hot and Cold Trailer Models
Up to 7000 psi
Flows up to 40 gpm
Powered Reels
Diesel powered models



We will custom build to your specifications

www.camspray.com

800-648-5011



SEWER EQUIPMENT COMPANY OF NEVADA

12 MILES OFF THE LAS VEGAS STRIP

(702) 527-5100

FAST SHIPPING
CALL US FOR A QUOTE

www.sewerequipmentcompanyofnevada.net

Live Tech Support
Parts & Accessories Available
For All Equipment

Electric Mini Jetters
Prices Starting at \$1,199



Gas Engine Portable Jetters
Prices Starting at \$2,699



Sewer Camera & Locators
Packages Starting at \$2,599
3 Year Warranty



Mainline & Mini Cameras
Prices Starting at \$1,399
3 Year Warranty



WE REPAIR ALL BRANDS OF SEWER CAMERAS

NEW!

MORE WITH **LETS**

LETS6.0



Now you can quickly inspect laterals with the new LETS 6.0 operating in 6-inch to 30-inch diameter mainlines. This completely upgraded system can increase your productivity and uptime:

- Fast camera launching with improved contoured chute
- Efficient 135-degree with-the-flow launch angle
- More power to traverse pipe against flow
- Pan & Tilt camera with self-cleaning lens
- Rear view camera

Keep your crews moving. Get more with LETS.

ARIES
INDUSTRIES, INC.

See what you're missing.

www.ariesindustries.com
(800) 234-7205



Win the Sale Without Losing on Price

Use these strategies to turn price objections into opportunities to educate your customers

By Judy Kneiszel

Cleaning and rehabilitation contractors, like parents, can be undone if they constantly cave in to whining. If parents give in every time a child begs for candy, mom and dad will pay for it in dental bills. A cleaner who gives in every time a potential customer complains about price eventually pays for it with diminished profit margins. Saying yes is easier in the moment, but in the long run it leads to decay.

You can employ several tactics to avoid caving in when a potential customer protests that your price is too high, and still win the contract. Some require you to look at your long game and overall pricing strategy. Others are simple strategies you can try in the middle of your pitch to get the potential customer to shift his or her thinking about price.

1. Know exactly what the customer is objecting to. Sometimes people abruptly cut off a sales pitch early by announcing that the price is simply too high. But if someone has been interested enough to listen to an entire proposal and an objection to the price is only thrown out at the end, you need to determine what the customer means when he or she says your price is too high.

It could mean that the price you are quoting is literally higher than they can afford right now. Financing or an alternate payment structure could be proposed as a solution.

If the customer believes that the same service is available for less from a different provider, try to determine if they are comparing apples to apples. Point out the advantages of your proposal. If your price is higher because you're proposing a longer-term solution, explain how the short-term fix could end up costing more in the long run.

Calling out your proposed price as too high could also mean that the service you are offering is not worth the price to them. The customer may say your price is too high, but what they mean is that it's not too high for what it is, but for what they need. Start over and this time listen to the customer and present an accurate price for what is truly needed, rather than what you'd like to sell them.

2. Get out the calculator. Don't spend a lot of time discussing the total price. Rather than focus on the price of an annual maintenance contract, break it down by the month, week and day to show the cost is reasonable. Explain how the daily cost may be less than the price of a fast-food meal or a good cup of coffee and ask if it isn't worth that small amount to protect their property. Take the price they had in mind or said they could afford and stress the small difference between your price and theirs.

3. Show your hand. It's hard to determine the true price of anything these days. Most retailers offer merchandise at 25 percent off so frequently customers start to wonder if anyone ever pays regular price for anything anymore. So it's no wonder a customer's gut reaction is to feel ripped off

when you give them a number. Explain how you arrived at the price. Have a pricing structure in black and white that you can show the customer and make it a company policy that the price is the price. Show the customer how difficult it was to get the number as low as you did. Explain how long your rates have been in effect even though costs have gone up. Seeing how slim your margins are might make them feel camaraderie with you. If the price is the price for every customer, they'll know what their competitors are paying and may be less likely to balk. Most people just want to feel like they are being treated fairly.

4. Don't take it personally. It's easy to become defensive when a customer rejects the price you've quoted. But don't feel like they are questioning your integrity or your intelligence. They are just doing what today's "buyer beware" culture has conditioned them to do. They are looking to protect their business interests just like you are. So try to put yourself in their place and reiterate the benefits of what you are proposing. Price objection is your invitation to further educate a customer about the quality of your products and services.

5. Act like you've already closed the deal. Even if the customer hasn't signed on the dotted line, talk to them like they have. Say, "When we arrive at your location" or "We'll be cleaning your lines every other month." The customer is less likely to say the price is too high if it seems like you've already struck a deal.

In the end, value is the crucial selling point when dealing with a customer who rebukes your price. You may find yourself explaining how paying a little more for quality service is a better value than saving a little money now but paying later when their sewer line backs up.

Investor Warren Buffett famously said, "Price is what you pay, value is what you get." The key to winning over a cost-conscious customer is getting him or her to appreciate the value of the service you offer, while accepting the price as fair. **C**

It's your magazine.
Tell your story.

Cleaner welcomes news about your drain and pipe cleaning/rehabilitation operation. Send your ideas to editor@cleaner.com or call 800-257-7222.

AMAZING MACHINERY

Your Equipment SUPERSTORE Since 1995

Introducing the
All New
4000PSI @ 18GPM

Brute Jet Max Trailer Jetter



**FREE
WARTHOG
NOZZLE
WITH PURCHASE**

**STARTING AT
\$26,995**

- Twin Kohler Gas Engines with Electric Start
- Belt Drive Ceramic Plunger Pump
- 15 Gallon Gasoline Fuel Tank
- 525 Gallon Water Tank with Plumbing
- Low Water Shutdown
- Automatic Tank Overflow Shutoff
- SUPER DUTY 12V Electric Hose Reel
- 400'-1/2" Low Friction Sewer Hose

- Aqua Pulse Feature & Adjustable Pressure
- Foot Pedal Valve Water Flow Operation
- 6 Piece Sewer Nozzle Kit with Cleaner
- Deluxe Tongue Mounted Tool Box
- 2 Rear-stack Mounted Hose Reels: 200' High Pressure Hose Reel; 100' - 3/4" Garden Hose Reel
- 50' Wash-down Hose
- Wash-down Gun, Wand, & Tips
- For Cleaning up to 16" Sewer Lines

TRAILER SPECIFICATIONS

- 5 x 12 Tandem Axle Trailer
- Electric Trailer Brakes
- Easy Ride, 3500lb Leaf Spring Axles Pump
- Steel Diamond-Plate Floor
- 15" - 6 ply Tires, Alloy Wheels
- Low-Rise Rails for Equipment Protection

*NOTE: This model has 2 Engines and 2 Pumps. These units can be run in Economy Mode (4000PSI @ 9 GPM) with only one engine running or Max Mode (4000PSI @ 18 GPM) with both engines running.

22 MODELS TO CHOOSE FROM, STARTING AT \$7,995

6 Months, No Interest!



Get 6 Months to Pay on Purchases of \$99 or More.
Choose PayPal Credit® at Checkout. Subject to Credit Approval.



Complete Details At
www.AmazingMachinery.com

1-800-504-7435
3807 Old Tasso Rd. • Cleveland, TN 37312

collaborate understand deliver

Demand More from Your Data.



It's what our industry has been waiting for—the power to share inspection results in real-time via the cloud, scale for big data, visualize system-wide condition with GIS, plan/track field operations via Google Maps, and generate high-level deliverables like heat maps, budgetary proposals and 3D system models.



real-time insight

sold & supported by:
www.pipelineanalytics.com • (877) 626-8386



COXREELS[®]

LEADING THE INDUSTRY THROUGH INNOVATION AND QUALITY

COXREELS SINCE 1923

1600 SERIES
V100 SERIES
1125 SERIES
100 SERIES

MADE IN THE USA
QUALITY • SUPPORT

THE BEST MOST RELIABLE & COMPLETE LINE OF HOSE, CORD, AND CABLE REELS

WWW.COXREELS.COM | 800.269.7335 | INFO@COXREELS.COM

Professional-Grade Drain Cleaning Machines, Cables & Accessories

Drain Cleaning Machines

- > Heavy duty construction
- > The most powerful motor in the industry
- > Quick and easy reel changeover
- > A one year rock-solid warranty

Cables

- > Fabricated from high quality wire
- > Most ends & couplings available
- > All sizes and lengths
- > Innercore available

COAST MANUFACTURING
THE PROFESSIONAL CHOICE

WWW.COASTMANUFACTURING.COM
1.800.541.7015

Blast More



Away.

Introducing Jetstream's 650hp TwinForce™ and 600hp 6000 Series Water Blasters

Our two new high flow, high horsepower water blasters pack a punch with up to 650 HP and have the power and reliability to make your job easier. They also come with the Jetstream® RightStart® training program as well as nationwide service support, parts and accessory availability, and water blasting application expertise - so you can focus on your business and increasing productivity.

To learn about how Jetstream can improve your productivity, call 800-231-8192 or visit www.waterblast.com.



A proud member of the Federal Signal Family.

© 2015 Federal Signal Corporation



www.waterblast.com 1.800.231.8192

Jetstream® TwinForce™ and RightStart® are registered trademarks of Jetstream of Houston, LLP.

2016 PORTABLE JETTER & CABLE MACHINE COMPANY DIRECTORY

	MAN/DIST. OF PORTABLE JETTERS	MAN/DIST. OF CABLE MACHINES	DRUM/REEL CAPACITY RANGE	PIPE DIAMETER RANGE	PRESSURE RANGE	VOLUME RANGE
<p>ALLAN J. COLEMAN CO. See ads pages 23, 67 5725 N Ravenswood Ave., Chicago, IL 60660 773-728-2400 • (f) 773-728-2499 www.allanjcoleman.com • info@allanjcoleman.com</p>	●	●	25' - 200'	1 1/4" - 10" 3/4" - 12"	1350 - 4000 PSI	1.3 - 65 GPM
<p>AMAZING MACHINERY, LLC See ad page 51 3807 Old Tasso Rd. NW, Cleveland, TN 37312 800-504-7435 • 423-790-1600 • (f) 800-504-7436 www.amazingmachinery.com • sales@amazingmachinery.com</p>	●	●	35' - 150'	1 1/2" - 16" 2" - 8"	1000 - 6000 PSI	2 - 22 GPM
<p>AMERICAN JETTER See ad page 81 6908 Pine Grove Rd., Knoxville, TN 37914 866-944-3569 • 423-472-2527 • (f) 423-472-2531 www.americanjetter.com • andy@americanjetter.com</p>	●		50' - 500'	1 1/2" - 8"	2000 - 5000 PSI	4 - 10 GPM
<p> CAM SPRAY See ad page 48 520 Brooks Rd., Iowa Falls, IA 50126 800-648-5011 • 641-648-5011 • (f) 641-648-5013 www.camspray.com • sales@camspray.com</p>	●		100' - 500'	2" - 24"	1500 - 5000 PSI	2 - 30 GPM
<p>CENTRAL OKLAHOMA WINNELSON See ad page 40 5037 NW 10th St., Oklahoma City, OK 73127 888-947-8761 • 405-947-8761 • (f) 405-947-1934 www.centralwinnelson.com • krjones@winnelson.com</p>	●	●	Up to 325'	Up to 12"	Up to 3500 PSI	6 GPM
<p>COAST MANUFACTURING See ad page 52 3985 W 12th Ave., Eugene, OR 97402 800-541-7015 • 541-684-0743 • (f) 541-485-3617 www.coastmanufacturing.com sales@coastmanufacturing.com</p>		●	35' - 150'	1" - 10"		
<p>DRAINABLES DIRECT See ad page 15 6615 Maumee Western Rd., Maumee, OH 43537 800-421-4580 • 419-838-6090 • (f) 800-752-8254 www.draincables.com • sales@draincables.com</p>	●	●	25' - 250'	3/4" - 10"	1500 - 3000 PSI	2 - 10 GPM
<p> DURACABLE MANUFACTURING See ad page 63 300 Ashworth Rd., West Des Moines, IA 50265 800-247-4081 • (f) 515-223-4220 www.duracable.com • sales@duracable.com</p>	●	●	Up to 250' Up to 150'	2" - 10" Up to 10"	Up to 3000 PSI	1.4 - 8 GPM
<p>ELECTRIC EEL MFG. See ad page 26 501 W Leffel Ln., Springfield, OH 45501 800-833-1212 • 937-323-4644 • (f) 937-323-3767 www.electriceel.com • info@electriceel.com</p>	●		100' - 300'	1" - 8"	1500 - 3000 PSI	1.7 - 4.7 GPM
<p>FORBEST PRODUCTS CO. See ad page 32 44130 Old Warm Springs Blvd., Fremont, CA 94538 877-369-1199 • 510-226-7988 • (f) 888-604-0107 www.forbestusa.net • forbestusa@gmail.com</p>		●	65' - 400'	1" - 20"		
<p> GENERAL PIPE CLEANERS See ad page 2 1101 Thompson Ave., McKees Rocks, PA 15136 800-245-6200 • 412-771-6300 • (f) 412-771-2771 www.drainbrain.com • info@drainbrain.com</p>	●	●	30' - 400' 25' - 150'	2" - 12" 1 1/4" - 10"	1500 - 3000 PSI	2 - 12 GPM
<p>GORLITZ SEWER & DRAIN, INC. See ad page 45 10132 Norwalk Blvd., Santa Fe Springs, CA 90670 877-446-7548 • 562-944-3060 • (f) 562-944-7630 www.gorlitz.com • sales@gorlitz.com</p>	●	●	50' - 300' 35' - 150'	1 1/4" - 8" 1 1/4" - 8"	1500 - 3500 PSI	2.2 - 8 GPM

PORTABLE JETTER & CABLE MACHINE COMPANY DIRECTORY

	MAN./DIST. OF PORTABLE JETTERS	MAN./DIST. OF CABLE MACHINES	DRUM/REEL CAPACITY RANGE	PIPE DIAMETER RANGE	PRESSURE RANGE	VOLUME RANGE
 JETTTERS NORTHWEST 2222 15th Ave. W, Seattle, WA 98119 800-863-7867 • 206-283-5252 www.jetttersnorthwest.com • media@jetttersnorthwest.com See ad page 33	●		300' - 400'	1 1/2" - 12"	3000 - 4000 PSI	9 - 12 GPM
KEN-WAY CORPORATION 930 Roberts Rd., Sparta, WI 54656 800-533-0551 • 608-269-3752 • (f) 608-269-8129 www.ken-way.com • info@ken-way.com See ad page 81	●	●	25' - 150'	1.25" - 8"	1500 - 3000 PSI	1.5 - 4 GPM
MTECH 7401 First Place, Cleveland, OH 44146 800-362-0240 • 440-646-0996 • (f) 440-646-9953 www.mtechcompany.com • sales@mtechcompany.com See ad page 81	●		300' - 600'	4" - 60"	2000 to 4000 PSI	12 - 80 GPM
MYTANA MFG. CO., INC. 746 Selby Ave., St. Paul, MN 55104 800-328-8170 • 651-222-1738 • (f) 651-222-1739 www.mytana.com • mytana@mytana.com See ad page 43	●		Up to 300' Up to 150'	1 1/2" - 8" 1 1/2" - 12"	1200 - 3000 PSI	2 - 8 GPM
NLB CORP. 29830 Beck Rd., Wixom, MI 48393 800-328-8170 • 248-624-5555 • (f) 248-624-0908 www.nlbcorp.com • nlbmkgt@nlbusa.com See ad page 17		●	200' - 500'	5/8" - 1 1/8"	10000 - 20000 PSI	
 NOZZTEQ INC. 1497 Main St., #354, Dunedin, FL 34698 866-620-5915 • 603-413-6583 • (f) 603-413-6744 www.nozzteq.com • info@nozzteq.com See ad page 74	●		Up to 200'	3" - 8"	2000 - 5000 PSI	15 - 80 GPM
 PICOTE SOLUTIONS 20810 SE 18th Pl., Sammamish, WA 98075 219-440-1404 www.picotesolutions.com • tony@picotesolutions.com See ad page 28		●	1' - 100'	1 1/4" - 10"		
 RIDGID® 400 Clark St., Elyria, OH 44035 800-769-7743 www.RIDGID.com • RIDGIDinfo@emerson.com See ad page 9	●		25' - 300' 90' - 250'	1 1/4" - 10" 3/4" - 10"	1350 - 3000 PSI	1.4 - 5.56 GPM
ROOT RAT PO Box 740, Bolivar, OH 44612 800-288-7873 • 330-874-4300 • (f) 330-874-4448 www.rootrat.net • lloyd@chempure.com See ad page 44	●		100' - 400'	2" - 12"		
 SPARTAN TOOL, LLC 1506 W Division St., Mendota, IL 61342 800-435-3866 www.spartantool.com • customerservice@spartantool.com See ad page 88	●		115' - 500' 25' - 110'	1 1/4" - 36" 1 1/4" - 10"	1000 - 4000 PSI	2.2 - 35 GPM
THE CABLE CENTER, INC. 8318 Olive Blvd., St. Louis, MO 63132 800-257-7209 • (f) 314-432-8024 www.thecablecenterinc.com thecablecenterinc@gmail.com See ads pages 28, 75	●	●	25' - 400'	2" - 13"	1500 - 3000 PSI	2 - 12 GPM
WATER CANNON INC. 4044 W Lake Mary Blvd., Units 104-424, Lake Mary, FL 32746 800-333-9274 • (f) 888-928-9274 www.watercannon.com • sales@watercannon.com See ad page 86	●		50' - 550'	1 1/2" - 12"	1200 - 7000 PSI	2 - 12 GPM

WWW.CLEANER.COM

WATCH HOT NEW INDUSTRY VIDEOS, READ EXCLUSIVE ONLINE CONTENT,
PLACE A CLASSIFIED AD, READ THE CURRENT E-ZINE, SHOP THE CLASSIFIEDS . . .

VARCO

LIQUID WASTE HOSE & ACCESSORIES

ORDER TOLL FREE
866-872-1224

SHOP 24 HOURS A DAY 7 DAYS A WEEK
ONLINE AT WWW.VARCOPIUMPER.COM



VARCO LATERAL LINE/WATER JETTER HOSE

VARCO Branded and MADE IN THE USA;

We get it for cheaper, so we can sell it for cheaper.

- Lateral line hose has become the standard for the septic industry.
- Polyether-urethane cover provides exceptional cut, abrasion and fungus resistance.
- Sizes from 3/8" up to 1", Working pressures up to 4800psi.

PREMIUM PIRANHA SEWER HOSE

	DESCRIPTION	500 ft	600 ft
3/4"	Premium Pirhana Orange 2500psi	\$1,095.00	\$1,314.00
1"	Premium Pirhana Orange 2500psi	\$1,285.00	\$1,540.00
3/4"	Premium Pirhana Blue 3000psi	\$1,154.00	\$1,385.00
1"	Premium Pirhana Blue 3000psi	\$1,485.00	\$1,780.00



NEW
VARCO
JETTERFLEX
HOSE

PREMIUM
PIRANHA
SEWER HOSE



Comes on Plastic Reel - For No Extra Charge! No Cardboard to Get Wet!
Smaller sizes and lengths do not come on reel - check with your customer service rep for details.

PROUDLY
MADE IN
THE USA

NEW VARCO JETTERFLEX LATERAL LINE / JETTER HOSE

4000 psi rated • Safety Green - Pressure Tested • Precoupled assemblies MXM pipe thread fittings

***3/16" ON CLOSEOUT SPECIAL - SAVE 25%**

	50'	75'	100'	150'	200'	250'	300'	400'	500'	600'
1/8"	\$15.28	\$21.25	\$26.38	\$37.49	\$48.60	\$56.74	\$66.88	\$87.15	\$107.45	-
3/16"	\$21.23	\$26.95	\$33.60	\$44.89	\$56.84	\$68.80	\$80.75	\$104.66	\$128.58	\$152.50
1/4"	\$29.85	-	\$55.85	\$81.82	\$107.77	\$126.38	\$150.52	\$198.77	\$247.02	\$295.28
3/8"	\$62.08	\$91.28	\$105.54	\$151.12	\$215.06	\$259.57	\$304.05	\$382.09	\$469.43	\$556.77
1/2"	-	-	\$186.69	-	\$353.97	-	\$518.17	\$660.02	\$853.29	\$972.66

SOURCE KEY
5C16



ARTHUR PRODUCTS CO.
ENGINEERED SOLUTIONS



ALPHA-KIT

INCLUDES:

- Flusher Nozzle
- Penetrator Nozzle
- Deicer/Degreaser
- Sewer hose 50 ft
- Quick disconnect
- Carrying Case



Phone: 1.800.322.0510
Fax: 1.300.722.2698

E-Mail: apc@apclsq.com
Web: www.arthurproducts.com

ultra ultra ultra
LIGHT - VERSATILE - SAFE

ultraSHORE
P R O D U C T S



Quick to Install.
As light as 130lbs.



Roll Your Own.
Optional wheel kit.



Stacks easily with
2' & 4' high panels.

This is What Aluminum Shoring Was Meant to be!



1-800-683-8837

1-800-SHORING

CALL TOLL-FREE NATIONWIDE • 1-800-746-7464

www.shoring.com

"The Standard of the Industry"



Lateral Service Inspection SOLUTIONS

CUES **MPlus+**



PORTABLE

Quickly remove the control unit to be used separately for remote jobsites or for compact storage.



DURABLE

Features a durable and rust resistance 18 gauge stainless steel coiler frame.



RELIABLE

Manufactured for rugged reliability and designed to handle rigorous field use.



- Advanced text writing, observation coding, digital recording and more in a weather/water resistance enclosure.
- Complete integration with CUES mainline CCTV systems and GraniteNet asset management software.
- Robust companion for all trenchless cross-bore operations including pre and post inspection and location.
- Optional mini pan and tilt camera for the MPlus+ XL mainline push inspection with switchable frequency sonde transmitter and built-in wiper system.



800.327.7791 • www.cuesinc.com • salesinfo@cuesinc.com

Night Moves

Contractor gets creative with work schedule to minimize disruptions while rehabbing more than 5,000 feet of sewer interceptor

By Kyle Rogers

Lining a mile of large-diameter sewer pipe is no small task. Doing it in a residential area with strict time constrictions and no bypass is even tougher.

When the East Bay Municipal Utility District in Oakland, California, was ready to rehabilitate a deteriorating section of its collections system in 2012, it turned to J.R. Pipeline. The company had already used the Linabond system in 2000 to reline approximately 2,300 feet of pipe for the utility.

But from tedious preparations to get the pipe ready for lining, to tight windows for completing the work and extensive measures to avoid disturbing local residents, the job proved to be challenging for J.R. Pipeline, says Elisabeth Girma, project manager.

“There were a lot of lessons learned along the way,” she says.



A member of the J.R. Pipeline crew sprays structural polymer on the clean pipe interior.



Hydroblasting the interior of the East Bay Municipal Utility District's 75-year-old Wood Street Interceptor removed old mortar and exposed river rocks, creating a bumpy surface that made lining difficult.

tough job

- PROJECT:** Rehabilitate 5,200 feet of sewer interceptor damaged by corrosion
- CUSTOMER:** East Bay Municipal Utility District
- CONTRACTOR:** J.R. Pipeline, Perris, California
- EQUIPMENT:** Lining system from Linabond Inc.; 805/484-7373; www.linabond.com
- RESULT:** Liner installed successfully without significant disruptions to community

THE PROJECT

EBMUD serves about 650,000 people from nine different communities in an 88-square-mile area on the east shore of San Francisco Bay. An integral part of its collections system is the 9,000-foot-long Wood Street Interceptor, a 105-inch cast-in-place concrete pipe dating back to the late 1940s. Beginning in the mid-1990s, the utility started gradually rehabbing the pipe after identifying areas of extensive corrosion.

The 2012 contract with J.R. Pipeline called for relining more than 5,000 feet of the horseshoe-shaped pipe, as well as spot repairs along another 2,000-foot section. J.R. Pipeline used the Linabond system, a structural polymer spray-applied onto concrete pipe followed by a PVC liner impermeable to corrosives.

The overnight work schedule was the first challenge on the three-year project, Girma says. J.R. Pipeline crews would mobilize around midnight and be ready to enter the pipe by about 2 a.m. The night's work had to be wrapped up around 6 a.m.

“It's part of the main interceptor and there was no redundant pipe,” she says. “The pipe could not be taken out of service, so all the work had to be done at night when the flow was lower.”

Work was done from April to October, the area's dry season. Girma says EBMUD utilized a storage facility, typically only needed during wet-weather conditions, to keep the flow as low as possible throughout the night so crews could work in the pipe. A wood platform was constructed along the repair area about 2 feet above the bottom of the pipe before starting rehab preparations.

“At night the flow was already lower than during the daytime, and the utility would crank up its pump to direct more flow to the treatment plant and storage facility,” Girma says. “About 4 or 5 feet of flow in the pipe would be reduced to a height below the platform.”

“On top of that, we had a blower to clean the air in the pipe. So when we went into the pipe, the air was fresh, the sewage was below the platform and workers could do their work.”

IN THE NEIGHBORHOOD

The overnight work schedule was maintained until this past year, when J.R. Pipeline arrived at a portion of the interceptor running through a residential area and had to account for how the work might disturb the neighborhood. While pre-lining preparations could still be performed entirely underground by accessing the pipe via a manhole in a non-residential area, that strategy was not an option once it was time to actually start the lining process.

“For cleaning the pipe beforehand, we could just go through a manhole where there weren’t residences and walk down 2,000 feet into the residential area. People didn’t even know we were there,” Girma says. “But for the rehab process itself, the lining rig has to be very close to the area being repaired.”

For lining the sections of pipe in the residential area, J.R. Pipeline got permission to extend its daily work schedule to 10 a.m. Underground pipe preparations began at 2 a.m. so that the crew would be ready at 6 a.m. when it was allowed to mobilize above ground in the neighborhood for lining.

“EBMUD did all sorts of hydraulic monitoring to figure out how much longer they could hold the flow for us and determined that they could go until 10 a.m. before we had to be completely out of the pipe,” Girma says. “That was a big challenge because by the time we started doing the rehab work it would be about 7 a.m. and we had to start pulling equipment out of the pipe around 9:30 a.m. So it was going very slowly. We were able to do about 75 feet per day. Sometimes we could do 100 feet if we were lucky, but it was very tight.”

Working in the neighborhood also required additional measures to appease residents. “No Parking” signs had to be placed along the next day’s work route the night before.

“The worst thing that happened was we had to tow some cars. We did it several times throughout the process,” Girma says. “We just tried our best to take a proactive approach and provide notice to the residents and let them know this was a crucial project for the neighborhood.”

CONTINUED >>



J.R. Pipeline had to build a platform about 2 feet above the floor of the pipe to keep workers above the flow of wastewater.

HANNAY WORKS HERE



Put the hardest working reels to work for you with:

Pressure ranges from 300 PSI up to 10,000 PSI

Heavy-duty ribbed discs and one-piece axle hub assemblies

Low, hassle-free maintenance

Reels built to order with fast delivery



Made in U.S.A.



Find your local dealer: hannay.com or 877-467-3357

Hannay Reels®
The reel leader.

>>RIGHT: The J.R. Pipeline crew wrapped up the seven-month rehabilitation of the 9,000-foot-long Wood Street Interceptor in October.

BELOW: Contractors used the Linabond system to rehabilitate the 105-inch cast-in-place pipe, first spraying the interior with structural polymer and then applying sheets of PVC liner.



EBMUD also rented a space from a nearby church to give residents a parking alternative during the times they had to stay off the street. Security guards monitored the area.

PRE-LINING CHALLENGES

Scheduling logistics weren't the only challenge on the job, Girma says. After taking care of spot repairs on previously installed liner in 2012, J.R. Pipeline went into 2013 ready to begin applying the Linabond system to the new sections of corroded pipe. But workers found pipe that needed extensive prep work for lining to be effective.

The first step was bringing in an experienced hydroblasting contractor. Mac & Mac Hydrodemolition of Surrey, British Columbia, scoured the pipe's interior with 20,000 psi at 80 gpm to remove the corrosive buildup without damaging the good portions of concrete. That left large river rocks protruding from the pipe, creating a bumpy surface not ideal for lining.

"This pipe was cast in place, and in the 1940s when they built the pipe, they used river rocks," Girma says. "The mortar was decayed so it fell off after hydroblasting, but most of the rocks didn't come out. The surface was very rough, which required additional preparation work before beginning the lining system installation."

J.R. Pipeline also had to go through and put in new rebar where it had corroded, and clean exposed rebar and coat it with a corrosion inhibitor. Then mortar could be applied.

"This had to be done before lining could even begin," Girma says. "We'd be doing all this through July and finally begin lining in August."

Once it was time to actually do the lining, the process went well even though progress was slow due to the tight work schedule.

Last October, J.R. Pipeline completed the final 1,800 feet of lining outlined in the contract. The rehab work is far from over for EBMUD, as the utility continues to inspect its system and contract work out as needed. But for the foreseeable future, the Wood Street Interceptor shouldn't be a problem. **C**

DEEP TREKKER
EXPLORING NEW WORLDS

**THE ONLY TRULY PORTABLE
PIPE CRAWLER ON THE MARKET**

INTERNAL BATTERY POWER
FULLY SUBMERSIBLE
STEERABLE
STARTING AT \$9,999 USD
WWW.DEEPTREKKER.COM 1-226-646-3600



MODEL 900 ECO



got complexity?

No, just necessity



Rely on Reelcraft



Dual pedestal hose reels
Series 80000

Did you know... Reelcraft can build to your specs?

Special paint colors and finishes ▶

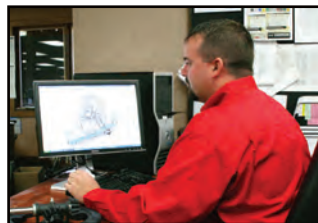

Reelcraft's Capabilities

- ✓ Built to your exact needs
- ✓ Very few size and weight constraints
- ✓ Special finishes/paint options
- ✓ Various drive types
- ✓ Wide range of pressures
- ✓ No minimum quantities

To learn more visit us at
www.reelcraft.com/custom



◀ Turn-key systems

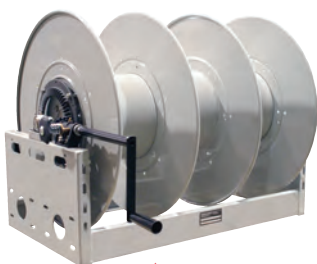

Multiple spools ▲



REELCRAFT®

www.reelcraft.com

800-444-3134

VSI Rentals, LLC.

51 Stone Road Lindenwold, NJ 08021
888-VAC-UNIT Fax: 856-627-3044

2014 Peterbilt 348 cab & chassis with a 3,200 U.S. gallon, carbon steel, D.O.T. certified 412 vacuum tank; dump type with full open rear door and a Presvac PVB 750 vacuum-pressure pump.

6 Available
Price by Request



2002 GMC, dual steer truck mounted, large capacity sweeper with dual sweep gear and catch basin cleaner unit
Price by Request

2014 Freightliner truck mounted combination vacuum and jetter units
3 Available
Price by Request



2014 Freightliner truck mounted, industrial wet/dry vacuum loaders with 27" Hg blowers
4 Available
Price by Request

Scan the QR code with your smartphone



**All Units Available For
Rent or Purchase
888-VAC-UNIT**

30-DAY
GUARANTEE
ON CABLE

**10% OFF
CABLE**

2-YEAR
WARRANTY

3-YEAR
WARRANTY

**20% OFF
MACHINES**



**30% OFF DRAIN
CARE***

Order Online at www.duracable.com

*Excludes PC4, PC5, private label drain care products and RootX. Promo #514. Valid May 1 - May 31, 2016. Orders subject to credit approval. Applies to Duracable Manufactured Equipment. Not valid on previous orders.

**BUILT
U.S.A.
TOUGH**

MADE IN THE
USA

Just give us a call at 877-244-0556.

The one-stop source for all your plumbing and drain cleaning needs – Duracable Manufacturing. Or visit us on the web at www.duracable.com

Duracable
Manufacturing Company

Residential and Commercial Sewer and Pipe Maintenance

By Craig Mandli

CABLE MACHINES

ELECTRIC EEL MODEL Z5-P

The **Model Z5-P** drain cleaning machine from **Electric Eel** cleans 1 1/4- to 3-inch-diameter lines up to 100 feet while running galvanized aircraft wire inner-core cable. It has a built-in drum shaft slip clutch and an upright frame on large 10-inch wheels with a folding handle. Its rear bar shields the motor and allows for two-position operation. It has a steel guide tube/inner drum. Kits include a three-piece cleaning tool set, tool bag, T-wrench and leather gloves. Several sizes of inner-core cable are available. **800/833-1212; www.electriceel.com.**



Electric Eel

PICOTE SOLUTIONS DRAIN CLEANING CHAINS

Picote Solutions offers high-speed, high-efficiency drain cleaning chains that attach to the Picote Miller drive units. There are two styles of chains, the Original and the Cyclone, that range from 1 1/4 to 10 inches. The Cyclone opens up to the inside diameter of the pipe to descale and remove even the finest of roots. The Original rolls around the inside of the pipe, removing roots and heavy tuberculation. An assortment of special drill heads and removal tools can be used for severe, heavy-duty roots and blockages, all without damaging the host pipe. To prevent further root infiltration, the Picote Coating System seals and forms a watertight, noncorrosive pipe. This easy-to-use system simply coats the pipe using a coating pump and brush application to work the resin into the host pipe. **219/440-1404; www.picotesolutions.com.**



Picote Solutions

RIDGID K-7500 DRUM MACHINE

The **K-7500 Drum Machine** from **RIDGID** has cable that spins at 200 rpm and fits 3- to 10-inch lines. The main drum holds up to 100 feet of 3/4-inch or 125 feet of 5/8-inch cable. A 600-watt universal motor and gearbox bear down as the cutter engages obstructions and includes audible and visual signals for the operator. The inner-drum and ball-bearing distributor arm work with the motor and gearbox system to reduce the chance of cable flip-over inside the drum. The main and inner drums won't rust, split or dent while the AUTOFEED advances and retrieves cable up to 22 feet per minute. The unit has a narrow profile and



RIDGID

handles that adjust to desired height to ensure balanced transport. **800/769-7743; www.ridgid.com.**

CLEANING NOZZLES

ARTHUR PRODUCTS PX REVOLVER G3

The **PX Revolver G3** from **Arthur Products** is designed for the operator who not only must service a line, but also have the ability to travel a long distance in the line. It has three additional fixed rear jets dedicated to generating large thrust for long runs. The addition of the rear jets allows the rotor jets to focus on penetration, polishing and flushing. It is manufactured from high-grade stainless steel and custom drilled for equipment. It is available in 1/4-, 3/8- and 1/2-inch NPT sizes. **800/322-0510; www.arthurproducts.com.**



Arthur Products

ENZ USA ROTODRILL BEND

At 2 3/4 inches long, the **Rotodrill Bend** nozzle from **Enz USA** easily negotiates traps and bends. The high-powered rotating jet provides thrust power and is effective for moving debris and tree roots and clearing blocked pipes. It pushes itself through pipes via a tapered front. The efficiency of this nozzle is generated upon retrieving it from the pipe, as it cleans and cuts out roots and deposits upon return. It can operate on flow as low as 4 gpm, while cleaning pipe ranges from 3 to 6 inches in diameter. It is available in 1/4- and 3/8-inch connections. **877/369-8721; www.enzusainc.com.**



Enz USA

NOZZTEQ JAWS 100

The **JAWS 100** sewer nozzle from **NozzTeq** is a NASSCO Tier 3 nozzle with internal conduits and spray angles designed to produce efficient, maximally powerful jetting streams using relatively low truck-supplied water pressures. Crews can clean more pipe with fewer passes, while generating less wear and tear on trucks and using less fuel. Its water conduits preserve laminar water flows from the truck to final jet stream, so water pressure is never compromised by turbulence. Tightly focused jet streams are deployed at precisely calculated angles that move out debris efficiently. It is made of low-carbon stainless steel with SBR covers that protect the conduits and jets. Jets can be switched as needed to accommodate water flows from 5 to 80 gpm and 3/8-, 1/2-, 3/4- and 1-inch connections. **866/620-5915; www.nozzteq.com.**



NozzTeq

STONEAGE SWITCHER

Switcher cleaning heads from **StoneAge** eliminate extra runs by switching between pulling and descaling jets. Technicians can use the same tool to quickly run down the line, then engage full cutting force to clear obstructions, and switch again to move debris. Every time the pump is idled down and brought back to pressure, the tool alternates function between

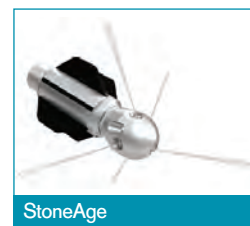

StoneAge

two different sets of jets. Field use of the WGR Magnum with Switcher head versus the traditional method of using two tools (rotational and fixed nozzle) demonstrates up to 35 percent less water usage and job times close to 50 percent faster. 866/795-1586; www.sewernozzles.com.

USB – SEWER EQUIPMENT CORPORATION ONE-PIECE NOZZLE

One-piece stainless steel cleaning nozzles from **USB – Sewer Equipment Corporation** are neither bonded nor screwed together, enhancing strength and reducing the chances of failure under pressure. Their advanced optimized 3-D hydromechanics, located in the lower part of the chamber, eliminate pressure in the upper portion of the nozzle and prevent explosion in a sewer line or manhole. The water from the pressurized hose is immediately guided directly into channels and smoothly directed into one-piece ceramic nozzle inserts, which do not require winglets or flow straighteners because of the hydromechanics in and out of the chamber. The result is a highly efficient jet pattern. 866/408-2814; www.usbsec.com.



USB

WATER CANNON WHIRLAWAY

With a 14-inch-diameter cleaning area, the **Whirlaway** rotary cleaning nozzle from **Water Cannon** simply snaps onto the pressure washer wand and is quick and easy to use. Used with either hot- or cold-water pressure washers with pressure up to 4,000 psi, its durable, lightweight design removes tree sap, dirt and other nonpermanent materials from hard surfaces. It blasts away dirt, grease and grime in all sorts of tough cleaning areas like pools, decks, sidewalks, warehouse floors, restaurants, retail shopping centers and garages. 800/333-9274; www.watercannon.com.



Water Cannon

GREASE TRAP MAINTENANCE

WESTMOOR CONDE PROVAC

The **Conde ProVac** industrial liquid waste pumping system from **Westmoor** is quiet and lightweight, and pumps at 120 gpm. A flip of the switch starts the unit in vacuum mode for pumping. The built-in exhaust deodorizer keeps odor at a minimum. Simply flip the switch to the pressure mode for off-loading. It is an intelligent solution for servicing locations not suitable for large vacuum truck hoses, including indoor or remote jobs such as grease traps. 800/367-0972; www.westmoorltd.com.



Westmoor

HIGH-PRESSURE HOSE

PIRANHA HOSE PRODUCTS ARMOR BELT

Armor Belt sewer-cleaning hose from **Piranha Hose Products** is lightweight, durable and abrasive-resistant. It is available in Series



Piranha Hose Products

SAOR, which is orange-covered, 2,500 psi and comes in I.D. sizes 5/8 to 1 1/4 inches; Series HABU, which is blue-covered, 3,000 psi and comes in I.D. sizes 3/4 to 1 inch; and Series LAGR, which is green-covered, 4,000 psi and comes in an I.D. size of 1/2 inch. 800/250-5132; www.piranhahose.com.

HOSE REELS

COXREELS V-117-850

The commercial-duty **V-117-850** vacuum reel from **COXREELS** is designed to extract unwanted particles and byproducts from the workplace. This direct hand-crank reel handles up to 50 feet of 1 1/2-inch standard vacuum hose with bullet cuffs. It has a solid one-piece U-shaped steel frame and open-drum design, with a no-thread direct-connect port for fast and convenient vacuum hose installation. It is lightweight, compact and has CNC robotically spun and ribbed discs with rolled edges for safety, strength and durability. 800/269-7335; www.coxreels.com.



COXREELS

HANNAY REELS N700 SERIES

With a narrow frame and compact mounting base, the **N700 Series** spring rewind reel from **Hannay Reels** is ideal for high-pressure washdown, sanitizing, and sewer, septic and portable toilet cleaning. A non-sparking ratchet assembly and declutching harbor prevents damage during reverse winding. The reel is designed to handle 1/4-through 1/2-inch I.D. hose and accommodate temperatures from -60 to 250 degrees F. Sealed ball bearings, ribbed discs and one-piece axle hub assemblies ensure long-lasting performance for sewer and waste operations. 518/797-3791; www.hannay.com.



Hannay Reels

REELCRAFT SERIES CTJ

Series CTJ hose reels from **Reelcraft** are designed for medium-duty applications for 200 feet of 3/8-inch I.D. or 150 feet of 1/2-inch I.D. high-pressure hose up to 5,000 psi. Hand crank with a balanced brass swivel and brass inlet, they are lightweight with a corrosion-resistant powder-coat paint. They have a drag brake to prevent de-spooling when the reel is not in use. 800/444-3134; www.reelcraft.com.



Reelcraft

JET/VAC COMBO UNITS

GAPVAX MC ADVANCED SERIES

The **MC Advanced Series** combination jet/vac from **GapVax** has display screens (one inside cab/one outside) to control hydraulics, blower and water pump operations with a complete complement of gauges. All body functions, boom and hose reel functions, vacuum break, throttle, and area and safety lighting are wirelessly controlled, while still maintaining proportional boom and hose reel control. The job card feature allows the



GapVax

operator to keep track of blower and water pump hours and logs time on each job. Specs include a 5- to 12-cubic-yard debris body and stainless steel water tank with a capacity of up to 2,000 gallons. Vacuum pump options range from 3,500 to 5,000 cfm with up to 27 inches Hg. The MC Series boom is an 8-foot, front-mounted, telescopic design with dual lift cylinders, reaching 26 feet with a 270-degree rotation. 888/442-7829; www.gapvax.com.

RING-O-MATIC 550 HiCFM VACEX HYDROEXCAVATOR

The **Ring-O-Matic 550 HiCFM VacEx Hydroexcavator** combines the safe cutting power of high-pressure water with a powerful vacuum suitable for potholing, sewer jetting, sump and catch basin cleaning, HDD job site support and mud management, construction site cleanup and environmental cleanup. It comes standard with a 50 hp CAT diesel engine and 1,000 cfm Gardner Denver positive-displacement blower. The Cyclo-Jet two-in-one pothole excavator attachment can safely dig a 3-foot hole in 30 seconds. 800/544-2518; www.ring-o-matic.com.



Ring-O-Matic

SEWER EQUIPMENT MODEL 900 ECO

The **Model 900 ECO** from **Sewer Equipment** is available in 9-, 12- or 15-yard debris capacities, equipped with Duraprolene water tanks carrying 900 to 2,000 gallons of onboard water, and up to 40 cubic feet of tool storage. Both single piston and triplex pump options are available at 55 to 80 gpm at 2,000 to 3,000 psi, a 4,400 cfm blower and 18 inches Hg, built on an eco-friendly platform, which provides greater fuel efficiency and offers noise reduction. 877/735-4640; www.sewerequipment.com.



Sewer Equipment

US JETTING JET VAC 500

The **Jet Vac 500** from **US Jetting** is compact and requires no CDL. It is easy to operate and has a low profile with nothing above the cab. It is designed to be mounted on a Ford F550 or similar truck. As a truck unit, it is capable of high lift dumping. It is also available as a tandem trailer-mounted unit with a 500-gallon debris tank, 250-gallon freshwater tank and a 3,000 psi at 10 gpm jetting package. It comes with 300 feet of 3/8-inch hose, a set of basic nozzles and a HATZ Tier 4 Final water-cooled diesel engine. It has a PD blower and a 4-inch suction hose. Both the blower and the jetter are hydraulically driven, allowing for better control and delivery of power for stand-alone jetting, vacuum or jet vac operation. With high-velocity tips, the customer has the capability of hydroexcavation. 800/538-8464; www.usjetting.com.



US Jetting

VAC-CON COMBINATION MACHINE

Vac-Con combination machines are available in configurations from 3.5- to 16-cubic-yard capacities, with hydrostatically driven two- and three-stage centrifugal



Vac-Con

compressors or several optional positive displacement blowers with up to 27 inches Hg. High-pressure, smooth-flow water systems are offered up to 120 gpm and 3,000 psi, with cross-linked polyethylene water storage tanks with total capacities up to 1,500 gallons to handle the cleaning of small- or large-diameter pipe. These machines can be equipped with a 180-degree articulating front-mounted hose reel in capacities up to 1,000 feet, and high-pressure hose diameters from 5/8 to 1 1/4 inches. There are front-mounted telescopic booms available with up to 10-foot extensions, and 8- and 10-inch tube diameter. It can double as a vacuum excavator with the optional hydroexcavation package. This allows the operator to reduce the volume of water, maintain the pressure for digging and direct the flow through a conventional excavation hand wand. 904/284-4200; www.vac-con.com.

VACALL ALLJETVAC

AllJetVac combination sewer cleaners from **Vacall** provide governments and contractors with collection performance features for sewer line maintenance, powered by a single chassis engine that slashes fuel consumption, cuts harmful emissions and reduces routine maintenance downtime. They have a strong positive displacement blower system for jetting action and vacuum power. The oval-shaped debris body has cylindrical sides for extra strength and efficient material dumping. Water tanks, fabricated from high-quality aluminum, are mounted high on the chassis away from road debris. Galvanized debris bodies and water tanks are available. The AllSmartFlow CAN-bus control system has a programmable LCD display that monitors engine, water flow and vacuum performance while allowing for more precise boom and reel movements. Water flow control monitoring can reduce trips for refills. 800/382-8302; www.vacall.com.



Vacall

PUSH TV CAMERA SYSTEMS/ACCESSORIES

CUES MPLUS+ XL

The **MPlus+ XL** push system from **CUES** includes a coiler configuration designed for larger pipeline applications up to 500 feet. It integrates swappable camera heads, a pan-and-tilt camera with 360-degree rotation and pan, video observation coding, observation coding interface and digital recording into an easy-to-use and intuitive package. This lightweight system includes large and durable wheels for easy portability and a balanced footprint for stability. It facilitates quick removal of the control unit to be used separately for off-road or remote job sites or to accommodate compact storage. 800/327-7791; www.cuesinc.com.



CUES

ENVIROSIGHT JETSCAN HD

Deployed on any 3/4- or 1 1/2-inch jetter hose, the **JetScan HD** video nozzle from **Envirosight** is a quick, easy way for a cleaning crew to determine what tools and setup to use, identify blockages during emergency call-outs and document the outcome of cleaning operations. It



Envirosight

CONTINUED >>

ALLAN J. COLEMAN

SINCE 1905

Call us today!
773-728-2400

5725 North Ravenswood Avenue • Chicago, IL 60660 • info@allanjcoleman.com • www.allanjcoleman.com



JM-1000

**Special pricing
on all
General jetters,
cameras and
machines**

**CALL FOR
GENERAL
SPECIALS**



JM-2900

Warthog® Nozzles



WD

WGP

WG Classic

WH

WHP

WS

WT

WV

Repair Center for: RIDGID SeeSnake, Gen-Eye, Radiodetection, Electric Eel, Vision Technology & Insight Vision Cameras Fast Turnaround Time

UPGRADE your camera system to the GVISION. A Better System



Visit www.eplsolutions.net for more details.

GVISION

Gvision V3 is a universal monitor capable of recording from a variety of camera reels. View the screen in the blaring sunlight or in the shade with no visible difference.

This ruggedized monitor records onto flash drives, hard drives, and an iPhone®, iPad®, or iPod Touch®. Connect to the A/V in/out connector to use DVD-RECs and other compatible recorders.



Ask what the **GPLAYER** can do for you?



JetSonde Carriers - P-Trap Cable Sonde Carriers

Turn ANY push camera into a Jetter Camera with the JetCam Adapter.

JetCam Adapter

JetSonde Nozzle

Jetter Hose



A specialized sonde for locating cast iron and non-metallic pipe 20+ feet deep.

OLDEST NAME IN THE BUSINESS
— Over 100 YEARS OLD —

PHCC MEMBER

captures valuable HD video footage from underground that can be viewed immediately afterward on a tablet. As it advances down pipe 8 to 24 inches in diameter, it records 720p HD video in MPEG format to an onboard SD memory card. Immediately afterward, the card can be removed and video viewed on an iPad or other SD-compatible device. Twin high-output LED lamps ensure bright, vivid footage. It lasts four hours on rechargeable lithium-ion batteries and stores up to eight hours of video. **866/936-8476; www.envirosight.com.**

FORBEST PRODUCTS FB-PIC3688A

The **FB-PIC3688A** 360/180-degree pan-tilt camera from **Forbest Products** allows users to generate panoramic pictures with remote directional control. It comes with a 2 1/4-inch waterproof high-resolution color camera head with zoom and 400 feet of fiberglass cable and reel with meter counter. The 600 TVL camera head has high LED lights, a wide angle of 130 degrees, focus of 10 to 60 mm and can work up to 30 meters under water. The heavy-duty waterproof control box includes a 10-inch LCD color screen with USB and built-in SD card to record photos and videos. Control buttons on the front panel are designed for controlling camera head rotation for more than 20,000 hours continuously. On-screen status indicators include footage of the cable pushed through the pipe. The built-in rechargeable battery lasts approximately three hours. **877/369-1199; www.forbestusa.net.**



Forbest Products

GENERAL PIPE CLEANERS GEN-EYE PRISM

The **Gen-Eye Prism** video inspection system from **General Pipe Cleaners** lets the user to use a tablet or smartphone to monitor and record inspection work. A Wi-Fi transmitter inside the unit sends video to a designated device up to 500 feet away. The command module weighs just 3 pounds and can be mounted securely on any GL or POD reel. An expandable cradle on top of the unit safely supports a standard-size tablet and easily adjusts for optimal viewing. Optional brackets for mini-tablets and smartphones are available. It offers an on-screen distance counter to track how much pushrod remains in the line, a nine-page titler with full keyboard to add company and job information to videos, a power port to keep the tablet or smartphone charged during inspections, date and time stamps for records, an LED dimmer control, and 2-, 3- and 6-inch trap skids. Its self-leveling color camera automatically keeps the picture right side up. **800/245-6200; www.drainbrain.com.**



General Pipe Cleaners

HAMMERHEAD TRENCHLESS EQUIPMENT PORTAVISION 3

The **PortaVision 3** lateral camera system from **HammerHead Trenchless Equipment** provides a one-touch system for inspecting pipe laterals that supports a wide range of pipe sizes with a durable self-contained unit. The 200-foot pushrod capability can be increased from its standard system to a 300- or 400-foot capability simply by



HammerHead

changing out its durable fiberglass spiral-wound pushrod reels. Wheeled camera skids are available for use with pipe diameters 8 to 12 inches. A hardwired connection to the monitoring unit's integrated USB port eliminates the need to purchase a dedicated computer notebook, netbook or laptop. The connection ensures high-quality recording. No Bluetooth or Internet connection is required. **800/331-6653; www.hammerheadtrenchless.com.**

HATHORN CORPORATION WI-FI CAMERA SYSTEM

The Wi-Fi camera system from **Hathorn Corporation** delivers 200 feet of pushrod attached to a slim 1.4-inch self-leveling camera head. It includes a 512 Hz sonde transmitter and a rechargeable lithium-ion battery pack, on-screen footage counter and adjustable lighting controls. The user can record video and take snapshots on any type tablet or mobile device up to 200 feet away with a custom mobile app. Recorded files can be emailed or downloaded straight to a computer. The system allows users to recharge their mobile devices directly from the control unit. **905/604-7040; www.hathorncorp.com.**



Hathorn Corporation

ID-TEC C70

The **C70** camera nozzle from **ID-TEC** is a combination of a video and cleaning nozzle for diagnosing and jetting 7- to 30-inch pipelines. It has seven replaceable jets for cleaning when moving forward, and a camera and lighting for video recording moving backwards. The video is recorded in the nozzle and downloaded to special software on a tablet via Wi-Fi when the nozzle is lifted out of the manhole. The software combines GPS coordinates with GIS mapping to determine the nozzle's location and nearby manholes and pipelines. The operator uses the software to review the video or to code the PACP report and to determine if further procedures are required for this line before he moves on to the next. It has internal memory and battery life for at least eight hours. Live view while jetting is a possible option. **503/504-8474; www.sr-series.com.**



ID-TEC

MYTANA MFG. COMPANY MS11-NG

The **MS11-NG** mid-sized video inspection system from **MyTana Mfg. Company** can be used to inspect 3- to 4-inch lines with up to 150 feet of range. It has a 1 1/2-inch color self-leveling camera head, built-in 512 Hz transmitter allowing a technician to locate during the inspection and a daylight-readable 6.4-inch monitor. Record or upload an inspection using the MyTana viewer app, available for iPhone, iPad and Android. Built-in Wi-Fi allows multiple viewers on relining/rehabilitation projects. Inspection records can be uploaded to YouTube or still photos emailed to customers. Media connects through RCA jacks on the front of the unit. **800/328-8170; www.mytana.com.**



MyTana Mfg.

CONTINUED >>

WATERJET PROTECTION

PROTECTIVE CLOTHING - WITH THE STRONGEST FIBER IN THE WORLD!



NEW! Available in
FR OUTER MATERIAL



PROTECTION LEVEL 1000
SINGLE 1000 bar/14500 psi
MOTOR 2000 bar/29000 psi
C.C. 8000/500

PROTECTION LEVEL 2000
SINGLE 2000 bar/29000 psi
MOTOR 2000 bar/29000 psi
C.C. 8000/500

+ **VENTILATION AVAILABLE**
GOOD WORKING CONDITIONS!

+ **FR OUTER MATERIAL**
AVAILABLE TO ORDER

+ **MAXIMUM PRODUCTIVITY**
FAST AND EASY GEAR UP!

+ **PROTECTION UP TO 43500 PSI**

+ **CE CERTIFIED**
VERIFIED PROTECTION



Find US distributors, News, Movies and E-catalogues, at:

WWW.TST-SWEDEN.COM

Need Jetting Hoses?

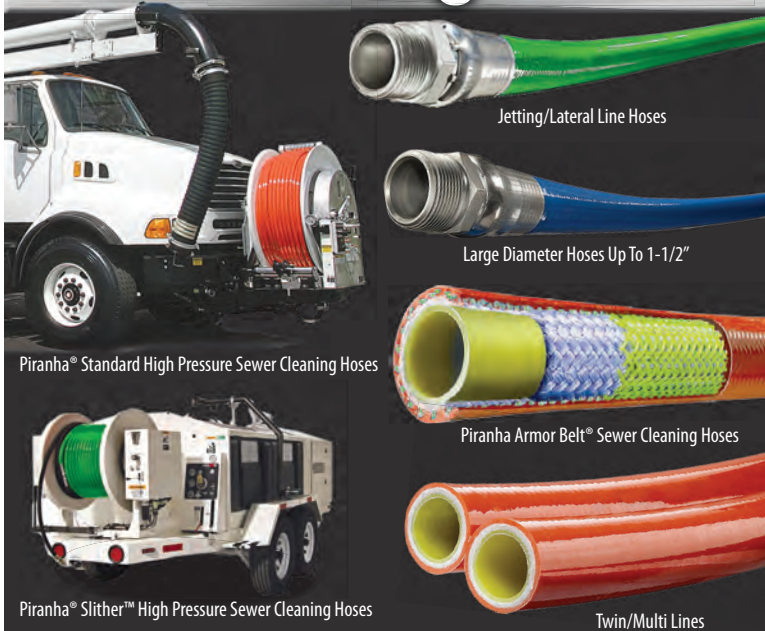

Jetting/Lateral Line Hoses

Large Diameter Hoses Up To 1-1/2"

Piranha® Standard High Pressure Sewer Cleaning Hoses

Piranha Armor Belt® Sewer Cleaning Hoses

Piranha® Slither™ High Pressure Sewer Cleaning Hoses

Twin/Multi Lines

For samples, literature and more information contact us at



Piranha Hose Products, Inc.,
Cadillac, MI
1-800-250-5132
www.piranhahose.com

What do you mean I have to inspect the main twice to inspect the lateral?

Not with Pipelogix software. Save time with the Pipelogix lateral inspection short cut.

- Survey mainlines and associated laterals as you go in one pass
- Each lateral and mainline inspection are individual surveys with separate video files and reports
- Condition analysis is easier and streamlined

Call today for a free online demo of our data collection tools for pipeline inspection pros.

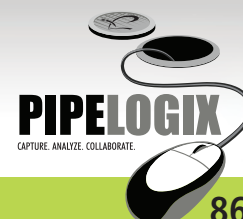

866.299.3150 www.pipelogix.com



PIPELINE RENEWAL TECHNOLOGIES CLEANSTEER

The **CleanSteer** from **Pipeline Renewal Technologies** uses high-pressure water for propulsion, steering and cleaning as it captures live inspection video from inside lateral lines. Its design makes it able to traverse multiple bends in pipe, steer through branches and levitate above debris, allowing municipal contractors and commercial plumbers to locate failed pipes, cross bores and blockages, as well as perform cleaning. It is fully water-driven, as six propulsion nozzles generate the power needed to pull its own flexible hose through multiple bends, and a side nozzle on the camera can be aimed to steer through diverging pipes and hover past obstacles. An optional forward-facing nozzle can be pulsed to clear debris and other obstructions. The system works with any high-pressure water source, including pressure washers and combination trucks. Its 1/2-inch hose comes in lengths from 115 to 190 feet. **866/936-8476; www.pipeliner.com.**



Pipeline Renewal

R.S. TECHNICAL SERVICES QUICK PEEK

The **Quick Peek** all-in-one, fully portable video inspection system from **R.S. Technical Services** is a compact, lightweight unit for drainline condition assessment in lines 2 to 10 inches in diameter up to 300 feet in length. The unit has a 7-inch bright LCD handle-mounted monitor equipped with a sun shield/screen protector that can be positioned for a comfortable viewing angle. Easily accessible monitor controls include power mode, aspect ratio (screen size) and menu, plus set buttons for color, brightness, contrast, tint and volume. The side-mounted AC/DC power source houses controls for all camera functions and provides a camera test terminal, AC/DC input, video/audio output, keyboard input and a condenser microphone with on/off switch. Options include battery power, a self-leveling camera, 512 Hz receiver, roller skids, laptop interface, SD card reader and Wi-Fi interface. **800/767-1974; www.rstechserv.com.**



R.S. Technical Services

RAPIDVIEW IBAK NORTH AMERICA 3D-GEOSENSE SYSTEM

The **3D-GeoSense System** from **RapidView IBAK North America** uses a sensor in the camera to provide users with a three-dimensional map of the lateral. The XYZ coordinates can be determined when the camera is moving both forward and backward, immediately providing the operator a real-life site plan with the width, length and elevation data of the lateral being inspected. The unit can be used in push or lateral launch applications. Additional third-party software is required. **800/656-4225; www.rapidview.com.**



RapidView IBAK

RATECH ELITE SD WI-FI

The **Elite SD Wi-Fi** pipeline inspection system from **Ratech Electronics** records pipe inspections wirelessly to an iOS or Android device, and takes live video and digital still photos that can then immediately upload to YouTube, meaning no more recording to USB thumb drives, SD cards or DVDs. Download an app to your iPhone or iPad and stream the video wirelessly. The Wi-Fi interface is available on any current Ratech product or existing Ratech systems in the field, and is available with a sun-readable 10-inch LCD monitor and either a self-leveling camera, small ultra micro camera or pan-and-tilt push camera. Systems come in cable lengths from 100 to 400 feet. **800/461-9200; www.ratech-electronics.com.**



Ratech Electronics

RAUSCHUSA MINCAM360

The 2-inch **minCam360** remote-controlled pan-and-tilt push camera from **RauschUSA** has a four-step zoom and a tri-band sonde with selectable frequencies. The Bluetooth remote includes a joystick for camera control. The cable reel comes with 200 feet of cable (it holds up to 300 feet), and the unit can run for four hours. The 8.4-inch sunlight-readable monitor enables recording video, voice and photo directly to an SD card. It is designed as a capable stand-alone inspection system, including a text generator for detailed reporting and an on-screen distance counter. It can be used in pipes 3 to 16 inches in diameter with all centering accessories. **717/709-1005; www.rauschusa.com.**



RauschUSA

SENSORAY MODEL 4011

The **Model 4011** from **Sensoray** is a compact digital video recorder designed for inspection systems. It records audio and video to USB storage media and can capture JPEG images on the fly without interrupting A/V recording. The outputs allow live video, recorded A/V or JPEG snapshots to be displayed on an external monitor. The date and time are maintained by a real-time clock with battery backup. The board encodes standard NTSC/PAL composite video using efficient H.264 compression. Each of the three overlay generators can position up to 160 text characters anywhere in the video frame. An external USB storage device is required for DVR operation. If desired, a second USB storage device may also be connected, and the unit will simultaneously record to both devices. A common application for this is recording to a removable device while creating an archival copy on a non-removable device. **503/684-8005; www.sensoray.com.**

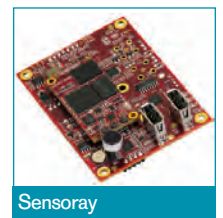

Sensoray

SPARTAN TOOL SPARVISION 200

At 25 pounds, the **Sparvision 200** pipe inspection camera from **Spartan Tool** is self-contained for easy on-the-job maneuverability. Outfitted with iPad or Samsung Galaxy S10 technology, it is intuitive to use, yet packed with features such as drawing on the screen to highlight problems, Wi-Fi for freedom of movement and simple emailing of video, and a full



Spartan Tool

CONTINUED >>

SCOOTER

VIDEO
INSPECTION SYSTEMS

20843 Santa Lucia • Tehachapi, CA 93561 • Fax: 661.822.8917

We are celebrating our

25TH ANNIVERSARY

With A

25% OFF
SALE

as a
THANK
YOU
to our
customers

Tired Of Squinting
At A Tiny Monitor?

Get An
Attaché
With A **15" LED**
Hi-Def
Monitor

"Simplify your life!"

SCOOTERS ARE EASY TO USE, TOUGH AND DEPENDABLE.
DON'T LEAVE THE SHOP WITHOUT ONE.



The new Scooter Attaché 1+ now includes a giant 15" LED hi definition color monitor as well as a high quality SD/DVR recorder, and has the capacity to operate other camera systems too!



800.772.6165

www.tvinspection.com

on-screen QWERTY keyboard. It includes 200 feet of ultra-slick pushrod and a self-leveling color camera. It offers instant snapshots and has a 512 Hz locating beacon and distance counter. 800/435-3866; www.spartantool.com.

VIVAX-METROTECH VCAMMX

The **vCamMX** all-in-one inspection camera from **Vivax-Metrotech** has an 8-inch daylight-viewable LCD, two-frequency locatable sonde, locatable pushrod, internal microphone, distance counter and a six-hour battery life through the rechargeable battery. The system is AC/DC powered so it can be run by AC wall sockets or via a vehicle charging lead. It has a choice of two high-resolution cameras – a 1-inch D26 self-leveling or a 3/4-inch D18. Both are changeable in the field by the user. It records directly to USB drives (up to 128GB) and can use up to a 64GB SD card for backing up the USB drive. This SD card backup allows the user to give the USB drive to a customer while retaining a copy. 800/446-3392; www.vivax-metrotech.com.



WOHLER VIS 350

The **VIS 350** visual inspection system from **Wohler** allows the technician to inspect pipelines, precisely locate damage and accurately document the results of the inspection. Inspect waterlines of 2-inch diameters and larger with a pan-and-tilt camera head to ensure no damage is overlooked throughout the pipeline. The camera head has an integrated transmitter that facilitates location detection by the L 200 locator, which has an easy-to-read color display. It can record video footage and store photos on a 2GB SD card for documentation and archiving purposes. 978/750-9876; www.wohlerusa.com.



RODDING MACHINES

POW-R MOLE SALES PD-6

The **PD-6** steerable and locatable hydraulic-thrust boring machine from **Pow-R Mole Sales** plugs into any 3,000 psi hydraulic source. This pit-launched directional thrust boring machine can be used for pipe installations of up to 200 feet in length. The 6-foot-long by 3-foot-wide unit allows for setup in confined areas where use of a directional drill is not possible. It is a dry-bore system requiring no water tanks or mud pumps, allowing for easy setup and avoiding messy cleanup. It can be used to help install water or sewer lines using any type of pipe. It is available with over 84,000 pounds of thrust and can install pipes up to 8 inches, or used to pipe burst existing utilities and replace with new HDPE pipe. An optional digital guidance system allows for the accurate installation of on-grade sewer lines. 800/344-6653; www.powrmole.com.

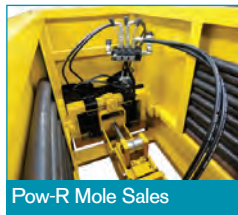

TRUCK/TRAILER JETTERS

AMAZING MACHINERY BRUTEJET MAX

The **BruteJet Max** skid-mounted jetter from **Amazing Machinery** is fully self-contained and can be mounted in many applications. It is 65 inches long and 30 inches wide, and comes with a 12-volt electric hose reel (no outside power needed), 200 feet of jetter hose, two nozzles, a foot pedal and a complete set of washdown accessories. The 6-gallon fuel tank allows for an extended runtime and quick disconnects from the unit for offsite refueling. The power plant, reel and fuel tank are mounted to an all-aircraft-aluminum skid that won't rust. It offers pressures between 2,000 and 4,000 psi, and flow rates up to 11 gpm. 800/504-7435; www.amazingmachinery.com.



CAM SPRAY EJT SERIES JETTER

The **EJT Series Jetter** from **Cam Spray** is made in three versions – 12 gpm at 2,700 psi, 8 gpm at 3,700 psi or 7 gpm at 4,000 psi. Driven by a 690 cc Honda engine, it can jet up to 8-inch lines and accommodate root-cutting tools. It comes with 250 feet of jet hose, a manual reel, 150-gallon water tank with low-water shutdown, industrial finished trailer, laser nozzle, rubber gloves, face shield and tiger tail. 800/648-5011; www.camspray.com.



HI-VAC CORPORATION O'BRIEN 7000 SERIES

The **O'Brien 7000 Series** trailer-mounted jetter from **Hi-Vac Corporation** comes with water tanks and a sediment pump for easier cleaning and longer life. The trailer has the muffler and air cleaner mounted inside the enclosure for improved sight lines, electric reel control for smoother rotation and easier operation, and hydraulic and water gauges mounted in the main control panel for easier viewing. 800/752-2400; www.hi-vac.com.



HOT JET USA HOTJET III

The **HotJet III** from **Hot Jet USA** offers an output of 20 gpm at 3,850 psi (with an option to run at 35 or 70 hp with either hot or cold water), cutting roots with either a custom root-cutting tool or a Warthog nozzle in pipes up to 24 inches. It provides the option to run 300 feet of 3/8-inch line or 500 feet of 1/2-inch line, depending on the size of line the operator is cleaning. The 3/8-inch line is effective in cleaning 12-inch maximum size pipes and the 1/2-inch line is effective in cleaning up to 24-inch pipes. 800/213-3272; www.hotjetusa.com.



NLB CORPORATION 225 SERIES

The **225 Series** of water jet units from **NLB Corporation** improves productivity for pipe cleaning and similar applications, maximizing contractor flexibility and reliability. These diesel-powered triplex plunger pump units are easily convertible to any of seven operating pressures (up to 40,000 psi) and flows from 6 to 82 gpm. They offer a choice of heavy-duty diesel engines from 200 to 350 hp. Units are available with an UltraGreen package and environmentally friendly Tier 4 Final engines that comply with the latest EPA emissions regulations and can reduce operating costs. **800/227-7652; www.nlbcorp.com.**



NLB Corporation

SUPER PRODUCTS CAMEL JET 1600

The **Camel Jet 1600** truck-mounted, high-pressure waterjetting system from **Super Products** is used to keep municipal sanitary and storm sewer lines and laterals clean and free-flowing. It uses three rotationally molded polyethylene tanks to carry up to 1,600 gallons of water. The Lexan Containment System means users have additional safety protection from hose rupture or high-pressure water. Its heavy-duty triplex continuous flow water pump provides up to 80 gpm and pressure up to 2,000 psi. Various water pump and drive system options are available, as well as a front- or rear-mounted 180-degree rotating hose reel with a 1,000-foot capacity. **800/837-9711; www.superproductsllc.com.**

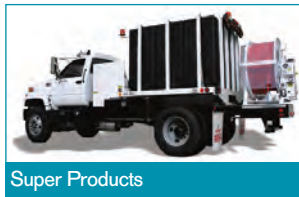

Super Products

VECTOR RAMJET

Vector Ramjet trailer jetters are ideal for fast, safe response to sewer blockages, as well as regular preventive line maintenance. The line of reliable, high-pressure water jetters is designed for cleaning municipal sewer, drain and pipelines, and culverts. They provide high pressure at low water volume and are ideal for cost-effective maintenance and emergency response in tight, confined environments. Jetters are available with a variety of engine and pump configurations, water tanks up to 1,000 gallons and a range of optional equipment. **800/627-3171; www.vector.com. c**



Vector

Residential and Commercial Sewer and Pipe Maintenance

By Craig Mandli

SERVICE TRUCK MAKES EASY WORK OF SEWER BLOCKAGE

PROBLEM

A large residential apartment complex in the Philadelphia Metro area was experiencing a major sewage backup. Raw sewage was overflowing out of an outside clean-out and pooling into the parking lot. The tenants of the apartment complex were upset over the problem and the accompanying sewage smell, and were pressuring the management company for a quick solution.



SOLUTION

Zoom Drain & Sewer Service arrived quickly with their **Hackney Zoom Jetting Truck**. Upon arrival, the service technician was able to clear the blockage within an hour. The organization and utility of the unit allowed the technician fast access to everything needed. The unit not only has a powerful jetter, but the space to house four to five additional drain cleaning machines and video inspection equipment.

RESULT

Residents were relieved at the quick restoration of their utilities, and the property management company was happy for the speed with which the technician was able to diagnose and provide the proper solution to get the line open. The streamlined setup of the truck combined with the strength of the jetter enabled the Zoom Drain technician to complete the job easily. **252/946-6521; www.hackneyservice.com. c**

**GET
EMAIL NEWS
ALERTS FOR
Cleaner**

Go to cleaner.com/alerts and get started today!

T&T TOOLS

T&T Tools, Inc.

Fax: 800.521.3260

Email: sales@mightyprobe.com

800.521.6893
www.MightyProbe.com

Call for a FREE Catalog



Call for a FREE Catalog

HOOKS...

- > Several different styles of heat-treated hooks are available
- > Top Poppers are great to open manhole covers
- > The Handy Hooks allow two handed use

PROBES...

- > Insulated, standard, and specialty soil probes
- > Metal shaft sizes: 3/8" round, 3/8" hex, or 7/16" hex
- > Replaceable tips are threaded on and hardened
- > A "slide" allows the handle to pound the shaft into the ground

AVOID HIGH START UP COSTS...RENT!

CIPP EQUIPMENT & MATERIALS
SALES | RENTALS | TRAINING

- Shooters
- Packers
- Cutters
- Trailers
- Training
- Materials
- Boilers
- Refrigerated Delivery



TTS TRENCHLESS SOLUTIONS

www.trenchless-inc.com

267.812.5855 | 1.855.LINE.TSI

We travel coast to coast for training and labor support!

Blown Toilets?

For Pipes 15" & up



BL Swiper™

Reduces incidences of Blown Toilet Effect and with the patented air channels can also be used for Venturi Effect with pipes full of water. Specially designed material also makes it safe for lined, PVC and sensitive pipes

For Pipes 8" to 18"

Equipment Engineered for Long Lasting Performance™



CALL FOR A FREE DVD



NozzTeq®
Taking Science to the Sewer!®

www.nozzteq.com
Toll Free 1.866.620.5915

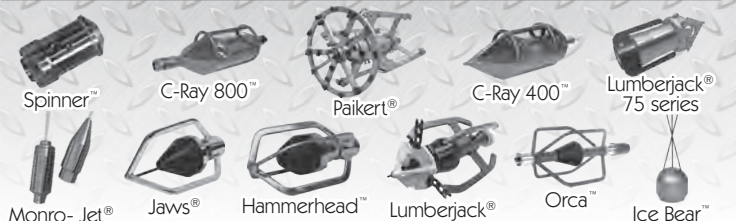



**24 HOUR TURNAROUND - MIDWEST'S LARGEST FACTORY AUTHORIZED
REPAIR CENTER FOR GEN-EYE, GATORCAM & SEESNAKE**

ClogChopper™

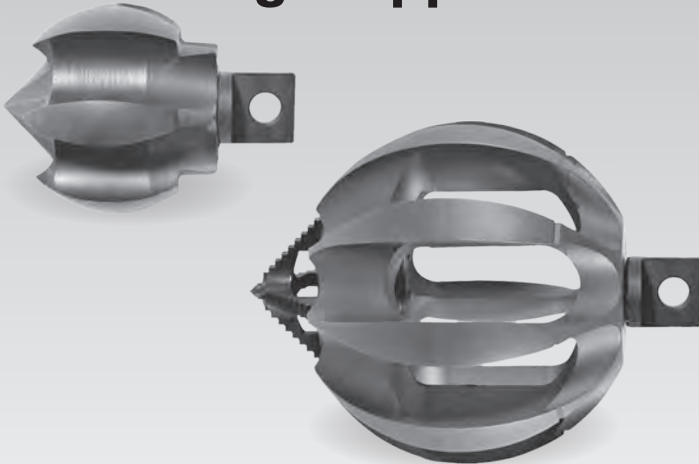

- Multi-function cutting tools
- Six self-sharpening blades
- Risk-free pipe damage
- Maneuvers around tight bends
- Safe cleaning on metal, plastic and clay pipes
- Variety of sizes
- Connector options for most drain cleaning machines

CALL FOR PRICING!

NEW Gen-Eye Hot Spot™ Pipe Locator



- Easy to read display – Icons lead you to your target and auto backlight lets you locate in dimly lit areas.
- Total field antenna array – Allows you locate from any direction.
- Line direction compass – Tells you the lay of the pipe.
- Industry's most rugged locator – Rated IP65, the industry's highest, it is dust and dirt proof and water resistant.
- Superior Battery Life – Batteries lasts twice as long as other brands.
- Expanded Frequencies – Locates two sonde frequencies, two power frequencies and four line frequencies.
- Upgradeable Software – Use the USB port to upgrade software in the field.

CALL FOR PRICING!

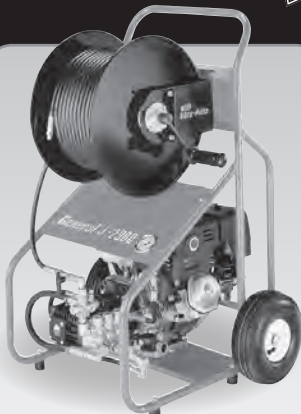

General J-2900
Basic Unit Machine Only

\$2745
FREE DELIVERY



General J-1450
Portable Jetter
Basic Unit Machine Only

\$1540
FREE DELIVERY



Mini-Rooter XP™
Basic Unit – No cable cutters
or power feed

\$580
FREE DELIVERY



General Speedrooter 92™
Basic Unit – No cable cutters
or power feed

\$1160
FREE DELIVERY

FREE FREIGHT ON ALL CAMERA KITS

PRODUCT SPOTLIGHT

Water Cannon duct cleaners attach to any pressure washer

By Luke LeNoble

Mosmatic Duct Cleaners from Water Cannon are designed to clean ducts, trash chutes, vents, restaurants hoods, tanks and more. The spinner attachment can be universally attached to any hot or cold pressure washer, making it a versatile tool for any cleaning contractor.

“You can connect it to the wand, or you can connect it to your hose,” says Mark Williams, national sales and product manager for Water Cannon. “Because of the versatility of what you can clean, you’re not limited to just ducts. A lot of grease trap guys are cleaning restaurants, so now they can offer to clean that hood vent as well.

“You can clean anything where you have to hit the sides of a pipe or wall because you can’t get a wand in there to hit all the spots. This is where a duct cleaner comes in handy; you can drop it through the hole, and then it sprays and rotates at about 1,500 rpm, so it will clean the

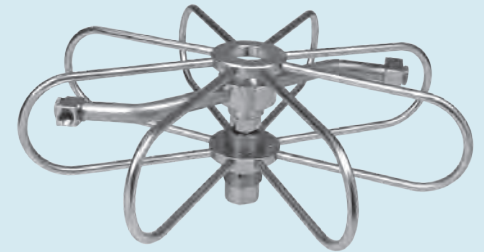
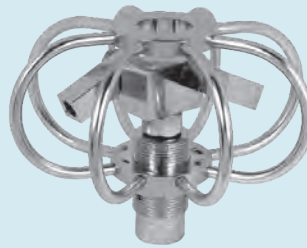

sides of the wall or whatever you’re cleaning.”

The duct cleaners are made of corrosion-resistant materials, feature self-lubricated steel bearings and an improved carbide swivel. They come in sizes from 3 to 32 inches.

Built to handle chemical ratings of pH 3 to pH 12 while withstanding temperatures up to 250 degrees F, operators can choose between fixed-arm or adjustable-arm models and prevent backsplash with an optional protective plate for sizes 12 inches and up.

“These duct cleaners are really a time-saver and very versatile, cleaning anything from a 3-inch pipe to a silo,” Williams says. “And it’s a high-quality product; they’re made to last.” 800/333-9274; www.watercannon.com/catalogrequest.aspx.



1



2



3



4

1 FRANKLIN ELECTRIC GRINDER PUMPS

Little Giant GP Series grinder pumps from Franklin Electric operate across 208 to 230 volts. The GP-A (automatic) and GP-M (manual) models are designed to handle low-pressure sewage applications and feature a cutter system that operates at 414,000 cuts per minute. Other features include a non-clogging, corrosion-resistant brass impeller; shut-off head of 130 feet; and a single-phase capacitor start/run motor with built-in overload. 260/824-2900; www.littlegiant.com.

2 COXREELS SPRING MOTORS

Factory-tuned spring motors from COXREELS are designed for safe and efficient reel retraction. More than 150 types of spring motors are available, including six varieties of spring thickness and three spring widths. There is no joint or attached hook connection, so the joints will never fail during retraction. The spring cans are available as pre-assembled replacement parts for easy removal and installation. 800/269-7335; www.coxreels.com.

3 ELECTRIC EEL PIPELINE INSPECTION CAMERA WITH WI-FI

The Ecam ACE pipeline inspection camera system from Electric Eel Mfg. Co. is designed to inspect 3- to 10-inch lines and features Wi-Fi, enabling users to record video with their mobile device. The system features a 5.4-inch LCD monitor and stainless-steel-housed 1.68-inch color camera with sapphire lens. A flexible camera spring can navigate 3-inch P-traps. Included is 200 feet of braided 1/2-inch pushrod, 512 Hz sonde and heavy-duty screen cover. 800/833-1212; www.electriceel.com.

4 MILWAUKEE TOOL HIGH-TENSION HACKSAW

The 12-inch high-tension hacksaw from Milwaukee Electric Tool Corp. was designed for contractors who need to make fast, accurate cuts. A reinforced metal frame provides extra durability. A high-leverage tension knob at the top of the frame enables the user to tighten the blade to the highest tension needed. It features six-blade storage capacity and a 45-degree blade position for a better angle on flush cuts. 800/729-3878; www.milwaukeetool.com.



5



6

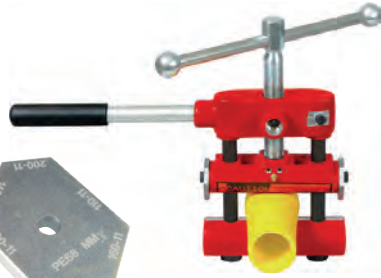

7

Deploy longer lengths of fiber optic cable from a single drum.

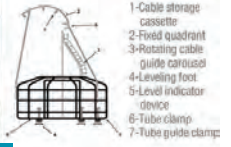

8



9

5 XYLEM DEWATERING PUMP

The Flygt 2190 submersible dewatering pump from Xylem is built to handle abrasive liquids. The mid-sized pump is available with two impeller options: The Dura-Spin safeguards against wear by sweeping abrasive particles away from the impeller neck, while the semi-open impeller increases uptime by preventing fibrous solids from obstructing the pump. The pump's conical trim sleeve restores clearances to near-original condition. **704/409-9700; www.xyleminc.com.**

6 REED MANUFACTURING POLYETHYLENE SQUEEZE-OFF TOOLS

Polyethylene squeeze-off tools from Reed Manufacturing Co. stop flow in 1/2- to 8-inch PE pipe. Different models handle a wide range of pipe sizes and applications. Sliding bar handles make work in tight places easier and increase leverage for tightening. Positive stops in metric sizes are also available. **800/666-3691; www.reedmfco.com.**

7 GENERAL MACHINE PRODUCTS MICROFIBER CABLE FLETERS

Micro and mini microfiber cable fleeters from General Machine Products (GMP) are designed to ensure cable protection from pedestrians or vehicles and prevents outside contamination. Cable fleeters replace the manual method of "figure-eighting" cable at deployment midpoints, saving time and money. They are designed to work in conjunction with the GMP Breeze and Air Stream Cable Blowing Machine brands. The micro fleeter can accommodate

0.19- to 0.33-inch microfiber cable with a maximum cable handling of 6,500 feet by 0.33 inches. The mini fleeter can accommodate 0.19- to 0.43-inch microfiber cable. **215/357-5500; www.gmptools.com.**

8 HONDA POWER EQUIPMENT GROUND FAULT CIRCUIT INTERRUPTER

Ground fault circuit interrupter (GFCI) technology has been added to three of Honda Power Equipment's generator models: the EB6500 Industrial Series, the EM5000 Deluxe Series and the EG4000 Economy Series. Each comes with GFCI 20-amp duplex receptacles. **678/339-2600; www.powerequipment.honda.com.**

9 DITCH WITCH MUD RECYCLER

The MR90 mud recycler from Ditch Witch allows operators to reclaim, recycle and reuse drilling mud. It can be transported full of fluid and features a 24.8 hp Kubota Tier 4 engine. A 110-gallon clean tank and 340-gallon first-pass mud tank have 3-inch ports for vacuuming out mud. A 300-gallon freshwater tank provides extra drilling fluid capacity and support for equipment cleanup. A rear onboard spoils hopper catches all screened spoils and an integral mixer allows drying additives to be mixed into the spoils and discharged. A Flomax pump controls fluid flow for mixing, cleaning and transfer of fluids to drill. Automatic pit pump control prevents overflow. Commercial-grade trailer (14,000 GVWR) with standard LED lights is optional. **800/654-6481; www.ditchwitch.com. c**

Get more news, information, and features with our exclusive online content.

www.cleaner.com/online_exclusives

Continental ContiTech to expand industrial hose plant

Continental ContiTech announced a \$7.2 million expansion of its industrial hose plant in Mount Pleasant, Iowa, in response to increasing demand for industrial hoses in the NAFTA region. The company expects construction to be completed by the end of the year.

Hydra-Flex names national sales manager

Hydra-Flex named Joshua Pelovsky national industrial sales manager. Based out of the company's corporate headquarters in Burnsville, Minnesota, he will focus on hydroexcavation and industrial cleaning products.

Dwyer Group service brands recognized

Nine different Dwyer Group service brands, including Mr. Rooter, were ranked in *Entrepreneur* magazine's latest Franchise 500 list. Published annually, the list ranks franchise concepts based on emerging trends and industries headed for growth in the coming year. Mr. Rooter ranks 380 on the list.

Spartan Tool names sales manager

Spartan Tool promoted Eric Boonstra to sales manager. He will support the needs of the company's customers by coordinating and communicating with the territory managers, customer service representatives, engineers and the factory.



Eric Boonstra

Link Manufacturing recognized for 20 years of ISO certification

Link Manufacturing was recognized for achieving 20 years of continuous ISO Quality Certification. The company is ISO 9001-, ISO/TS 16949- and ISO 14001-certified. It first received ISO 9001 certification in 1995.



Vac-Con saves \$150,000 on sales tax exemption

Vac-Con, in the midst of an \$11 million plant expansion, hosted Florida Gov. Rick Scott in January at a stop on his Million Miles for a Million Jobs Tour. Vac-Con plans to hire about 60 employees as a result of the expansion.

Isuzu sets truck, parts sales record

Isuzu Commercial Truck of America set sales records in 2015 for sales of Isuzu commercial trucks and parts. Dealers in the United States sold 20,725 Isuzu trucks in 2015, a 10.5 percent gain in Isuzu N-Series sales versus 2014. The company also sold 5.5 percent more parts in the U.S. than it did in 2014.



Franklin Electric supports military vet with home water system solutions

Franklin Electric was one of several manufacturers that teamed with the national television series *Military Makeover* to provide retired military veteran Kevin Parke and his family of seven with multiple water system solutions for their home in Crestview, Florida. Franklin Electric's pumping solutions included an Inline 400 pressure boosting system, Koi pond water feature, Little Giant WRS Series compact water removal system, Little Giant VCMX-20 Series condensate pump and a Little Giant disappearing fountain feature.

Jenny Products electric air compressors achieve UL certification

Electric air compressors by Jenny Products have been certified to UL 1450 and C22.2 No. 68-09 safety standards covering motor-operated air compressors, vacuum pumps and painting equipment for the United States and Canada. The requirements met for the certification were issued by the Canadian Standards Association, which found that Jenny air compressors met the high safety standards of the UL 1450 code.

Vermeer names board members

Vermeer appointed Robert Hund and Scott Nelson to its board of directors. Both are veteran corporate executives within the industrial equipment manufacturing industry.

Ditch Witch awards 2015 Crescent Club memberships

Ditch Witch, a Charles Machine Works Company, recognized 10 dealerships for superior customer support with membership to the company's Crescent Club Top 10. Receiving the honor were Ditch Witch of Minnesota & Iowa, Ditch Witch of North Carolina, Ditch Witch of Alabama, Ditch Witch of Central Texas, Ditch Witch of Virginia, Ditch Witch UnderCon, Ditch Witch of Oklahoma & Arkansas, Ditch Witch Central California, Witch Equipment Company and Ditch Witch Sales Inc.

Federal Signal opens FS Solutions facility

Federal Signal's Environmental Solutions Group opened an FS Solutions service center in Midland, Texas, as part of the group's expansion of FS Solutions locations and service offerings in key areas throughout North America. Centers offer parts and accessories for Federal Signal's Guzzler vacuum trucks and Vactor hydroexcavators, as well as other makes and models.



Hose Handle

Hose and Pipe Handle • One handed tool
 Snaps on and off hose/pipe easily • Does not conduct heat or cold
 • High levels of strength and durability



Rain Gear & Boots



Safety Clothing



Hose & Couplings

*We Can Service All Your Needs
 & ALL In One Place*

Call For A
FREE
 Catalog
 Today!

MRP 1.800.325.3730
 MILWAUKEE RUBBER PRODUCTS www.MilwaukeeRubber.com



**ANNOVI
 REVERBERI**
 High Performance Pumps

Jetter and Washdown Pumps



RTP 7.9-10 GPM @ 7250 - 8700
 RTF 36-40 GPM @ 1500
 RTJ 18.5 GPM @ 4000

Professional Strength
 Specialty Pumps

*"The First Choice When
 Quality Matters"*



RTX Pumps
 Model #'s 30-50-70-85-100
 7.9 - 26.4 GPM
 1450 - 4350 PSI

AR North America
www.arnorthamerica.com
info@arnorthamerica.com
 (763) 398-2008

Rotary Vane Vacuum Pumps

Since 1952

- Septic Tanks and Slurry
- Sewage Pipes
- Sanitary
- Oil Field Industries
- Milk and Water Tankers
- Agricultural



MEC II 13500



WPT 720

For More Information, Contact
info@bppna.com



Battioni®
 Pagani
 Pompe

Power
 at your service

Vector Manufacturing, US Jetting forge marketing agreement

Vector Manufacturing will market and distribute US Jetting trailer- and skid-mounted jetters under the Vector name to customers in North America.

Brown and Caldwell scientist to chair advisory committee

Tamara Sorell, chief scientist at Brown and Caldwell, was named chair of the steering committee of the Sediment Advisory Group (SEDAG) for the Society of Environmental Toxicology and Chemistry (SETAC). Sorell brings nearly 30 years of human health and ecological risk assessment experience to her new leadership role and is a nationally recognized sediments expert. **c**

Beyond
 buckets
 and blades.



FIND OUT HOW.
 FREE subscription at digdifferent.com



WWW.CLEANER.COM

DR DYNAMIC REPAIRS

We Repair:
General Wire, Ratch, RIDGID, Hathorn Corp.
Electric Eel, GatorCams, Vision Intruders
and Vivax Inspection Cameras,
Locators, Command Modules and Cables

**New & Refurbished Inspection
Equipment For Sale**

**Rental Equipment Available
Daily & Weekly Rates**

Ask About Our 48-Hr. Turn Around Time

**INSPECTION CAMERAS
ARE OUR
ONLY BUSINESS!**

973-478-0893

DYNAMIC REPAIRS
40 Arnot St., Unit 20
Lodi, NJ 07644
dynamicablerepairs@yahoo.com
www.dynamicrepairs.net

**Convert to
HOT WATER
PRESSURE
WASHING
and
JETTING**



\$1,399+

2GPM to 10GPM
118° Temperature Rise
4200PSI Rated
Wheel Kits optional

watercannon.com
800.333.9274

Over 25 years of building quality equipment

HotJetusa®

DRAIN LINE JETTING EQUIPMENT

**Most Versatile Jetter
On The Market!**



• 35 HP Vanguard
• Remote Control
• Cleans Drains from 2"-12"

**On Sale For Only
\$24,995!**

Fully loaded! Call for details!

1-800-213-3272
www.hotjetusa.com

Generator-Parts.com

Online parts breakdowns to help you troubleshoot and identify repair parts.

**FULL LINE OF GENERATORS
AND OEM PARTS FROM:**

GENERAC KOHLER Cummins Onan

MANY PARTS IN STOCK:

- Filters
- Fuel System Components
- Starter Motors
- Replacement Gaskets
- Solenoids
- Much More!

Same day shipping on in-stock inventory orders placed before 4 p.m. CST.

Our large midwest inventory reaches most places in 2-3 business days via standard shipping.

Government and Military Quotations Welcome

Trained & Certified Repair and Installation Staff
877-409-1618 • sales@generator-parts.com
Generator-Parts.com

THE "ORIGINAL" LIQUID SMOKE



Turbo Fog M45:

- Versatile
- Light Weight
- Compact
- Creates Dense Smoke

TURBO-FOG®
Since 1977

www.turbo-fog.com • 1-800-394-0678

ERICKSON

Tank & Pump



509.785.2955

**CALL FOR UPDATED LIST OF
EQUIPMENT**

WWW.ERICKSONTANK.COM

Masport®
PUMPS & QUALITY COMPONENTS

800 Rd. P5 S.W. / Quincy, WA 98848
fax: 509.785.3770
e-mail: sales@ericksontank.com
"TANKS" FOR YOUR BUSINESS!

WE TAKE TRADES

DYE TRACERS



Solutions for:

- Infiltration
- Septic Systems
- Cross Connection
- Leaks and more...

BRIGHT DYES
Division of Kingscote Chemicals

www.brightdyes.com • 1-800-394-0678

You Can Install Sewer and Water Lines (Without Digging A Trench)

Pipe Genies Do It All!
Ductile & Cast Iron, Clay & Concrete, ABS, PE & PVC

Pipe Genies Pull Any Pipe!
System Power From 20 Tons to 240 Tons!
(Rated for 1/2" - 30" Pipe)

Pipe Genies Work Anywhere!
The Most Compact Systems Available!

We have everything you need to get started making profits with pipe bursting!

www.TrenchlessAmerica.com
Toll Free 1 877 411 7473

T&T Tools, Inc.

800.521.6893

**CALL for a
FREE
Catalog**

Many styles Available



Insulated Soil Probes
(for locating)

Heat-Treated Hooks
(for covers, lids, etc)

www.mightyprobe.com

Waterblaster Rentals & Sales

Houston, Texas



Boatman Industries

1K to 50K psi
60 hp to 1000 hp
Waterblasters & Accessories
Used Equipment Sales

713-641-6006
www.boatmanind.com

The COMPLETE CCTV Sewer Inspection System from CYCLOPS ELECTRONICS



The CYCLOPS Vehicle Mounted Color TV System comes with choice of color camera and transporter.

The Economical Valu-Pac Color System is easily rolled on its own wheels and transported by pickup or van.

PORTABLE OR MOUNTED ON YOUR CHOICE OF VEHICLE

"Known for Prompt Service!"

CYCLOPS ELECTRONICS, INC.
Manufacturer of Quality Sewer TV Systems Since 1978

123 Commerce Ave. | Boerne, TX 78006 | Phone: 830-249-9756
E-mail: cyclopstv@gvtc.com | www.cyclopstv.com

SOLD

Reach over 26,000 professionals each month and sell your equipment in the classified section.

COLEpublishing
www.Cleaner.com



Let Us Build Your
JETTER



Diesel Propane Gas

AMERICAN JETTER.COM
866-944-3569

Superior[®]
SMOKE
For **SEWER TESTING**

Superior Smoke Fluid Systems
Smoke Candles • Smoke Blowers

MADE IN USA



Superior Smoke Testing
The Most Cost Effective Method to Find Sources of Surface Inflow

SuperiorSignal.com/Cleaner

KEN-WAY Beats the Others
DAY-IN • DAY-OUT
And they have for over 50 years

KEN-WAY CABLE CLEANERS
for cleaning sewer, drain or process lines
from one to ten inches, up to 75 feet
with the Junior and up to
a full length of 300 feet
with the Model 400



Junior Model 400

KEN-WAY Exclusive Built Cables



3/8" 13/32" 1/2" 3/4" 11/16" 5/8" 5/16" 1/4"

- Heat Treated
- Inner-Core or Non-Core
- Fit Most Other Brands
- Interchangeable with Most Brands
- Coupling or Blade Holding Types

KEN-WAY CORPORATION
Leasing plans available. Call for details.
1-800-533-0551

930 ROBERTS ROAD, SPARTA, WI 54656
www.ken-way.com • E-mail: info@ken-way.com

OBLITERATE ROOTS



OBLITIROOT
SEWER LINE
FOAMING ROOT KILLER

Up to 3x the active ingredient

www.olvidium.com (877) 477-5338



GET
EMAIL NEWS ALERTS FOR
Cleaner

Go to
cleaner.com/alerts
and get started today!



Cua Claws
A Simple Solution for
Slippery PVC Pipe -
The Right Wheels
We now resurface all makes
of steel transport wheels

CALL JERRY AT 714-697-8697
www.cuaclaws.com

CONFINED SPACE ENTRY PACKAGE ONLY \$2,995



- 4-Gas Air Monitor
- 7' Tripod
- 3-Way Fall Protection
- Work Winch
- Full Body Harness

Add a Blower with 15' of duct for only \$350!
Add a 5 Minute Escape Respirator for only \$500!

TECH 800.362.0240
www.mtechcompany.com

Extra! Extra!
Want More Stories?

Get extra news,
extra information,
extra features with
Online Exclusives

Exclusive online content
for *Cleaner*

www.Cleaner.com/online_exclusives

ADVERTISING

Equipment Decals/Stickers: 100 11" x 15" - \$295. No setup charge & fast turnaround. Free shipping. sales@stickers4all.com 844-744-6236 (C07)

BUSINESSES

www.RooterMan.com. Franchises available with low flat fee. New concept. Visit website or call **1-800-700-8062.** (CBM)

Fully-equipped Long Island, NY cess-pool cleaning company for sale. Established 50+ years serving Nassau & Suffolk Counties with excellent reputation and high-repeat customer base. High volume of drain cleaning calls every week. Best offer. 516-993-0446 (C07)

ROTO-ROOTER franchise for sale in Northeast AZ. Navajo and south Apache Counties. In business 27 years, owner wants to retire. Qualified buyers only, will carry paper with large down. Turnkey business, three vans, pump truck, John Deere backhoe and a lot more. 928-537-3123 (C05)

CATCH BASIN CLEANERS



2004 Sterling Camel Hydrovac - One owner, 46,000 miles, \$50,000. **2006 Sterling Camel Hydrovac** - One owner, 41,289 miles, \$135,000.

916-747-3819, CA C05

COMPUTER SOFTWARE

FreeServiceReminderSoftware.com,
FreeServiceDispatchSoftware.com,
FreeRouteManagementSoftware.com. (C05)

DRAIN/SEWER CLEANING EQUIPMENT

Used and rebuilt cable machines in stock: RIDGID K-7500, K-40, K-60, K-1500, Spartan #1064, #300, #100, Electric Eel model #C machines. The Cable Center: 800-257-7209. (CBM)

HAZARDOUS WASTE UNITS

New 3,200 U.S. gallon, carbon steel, DOT certified 407/412 vacuum tank; dump type with full open rear door and a Presvac PVB-750 vacuum-pressure pump installed on a 2016 Peterbilt 348 cab and chassis. (Stock #13634A-D) **www.VacuumSalesInc.com, (888) VAC-UNIT (822-8648).** (CBM)

1996 Ford with a Presvac 3,500-gallon, carbon steel, DOT vacuum tank with a Masport pump. (Stock #1829V) **www.VacuumSalesInc.com (888)VAC-UNIT (822-8648)** (CBM)

HYDROEXCAVATORS



2016 Vac-Con Xcavator mounted on an 2016 Freightliner 114SD, Roots 827 blower, 20gpm @ 4,000psi water system with winter recirculation, 410,000 BTU boiler, 12-yard debris body with vibrator, 8' telescoping flex boom. Truck is new - never used, FET has been paid, NO FET.

For more info call Jeff
317-258-4900, IN C06



2012 Guzzler Classic with full hydraulic boom. 63,000 miles, 2,208 blower hours. Kenworth T800 chassis. Very clean. Call for more information.

304-312-3818, WV C05

JETTERS



US Jetting Skid-Mounted Unit for Sale: 18gp/4,000psi, Gen II wireless remote control, 7-position swivel hydraulic power pull-out hose reel w/500 ft. Includes extra 320-gallon tank. Only 40 working hours. For pricing please contact:

dlong@usbsec.com C05

JETTERS-TRAILER



Xtreme Flow Trailer Jetter Hot/Cold! Model# HJ2TA8536, tandem axle trailer, 35 hp Vanguard 10 gpm @ 3,850 psi, 325-gallon water tank, 300' hose, General Pump. List \$36,995. On sale for \$32,995. Fully loaded!

800-213-3272
www.hotjetusa.com CBM



2001 US Jetting 4018: 18gpm @ 4,000psi, 300 gallons water. Low 120 hrs. Hatz diesel silent pack. Work ready. \$15,700

800-627-0778 C05

2000 John Bean Trailer Jet: 35gpm @ 2,000psi. 400-gallon tank, 400' new hose. \$11,000 OBO. 231-325-0052 or 734-365-4035. (CBM)

2014 Hot Jet USA jet trailer, 35hp Vanguard motor, 3,600psi. Only 25 hrs on unit! \$16,500. Call 503-757-9004. (C05)

(2) 700-gallon SECA tandem-axle trailer jets: 1998 unit: Diesel engine, rotating hose reel. \$22,000. 1996 unit: Gasoline engine, fixed hose reel. \$17,000. Both units city-owned and garage-kept, in great shape. Located in Fort Worth. Call Jeff 281-770-6714. (C05)

2014 Harben 4018 DSK 300P with 2014 Trailer: 14' aluminum insulated & heated with aluminum floors. Wireless remote. Machine hardly used. \$60K new. \$45,000. 609-503-9944 (C05)

JETTERS-TRUCK

Vac-Con Jet Truck: 2002 Sterling Acterra, mileage: 91,876. Tank capacity: 1,600 gallons. Motor: CAT 3126 210 horsepower. Transmission: Allison 2000P. Auxiliary engine: Cummins B3.9 - 110hp. Pump: FMC Model L1618SC. Articulating hose reel, two side-mounted tool boxes. Asking \$12,000. 406-447-5050 (C06)



2005 GMC 5500 Diesel PipeHunter 7834TM: Very low mileage. Vacuum set up 1 cubic yard, directional arrows circulation system. Two 600' reels, one 1/2" line, one 3/4" line. Operating pressure 3,000psi @ 40gpm

acbplumbing@hotmail.com
207-865-1172, ME C05

Spartan 738 water jet mounted in 2002 Ford E350 box truck. 139,000 owner-driven miles. Perfect for plumbing shop. Phoenix, AZ. \$11,000 OBO plus shipping. 602-509-7428 (C05)

2005 Sterling Acterra Vac-Con Jet Truck: Tank capacity: 1,600 gallons. Mileage: 64,143. Motor: CST C7. Transmission: Allison 3000 RDS. Water pump: FMC L1618SC. Auxiliary engine: Deutz Model 2012 138hp. Articulating hose reel, two side-mounted tool boxes. Asking \$15,000 OBO. 406-447-5050 (C06)

Jack Doherty Supplies Inc. offers a full range of late model combo units and DOT industrial vacuum loaders. Call us @1-800-3DOHENY. (CBM)

JET VACS



2005 Vac-Con VPD4211LHA/1300 on International 7400: DT466 engine, Allison auto transmission, 88,640 miles. Deutz 138hp auxiliary engine, long telescopic boom, hydrostatic drive, articulating 600' x 1" hose reel, 1,300-gallon water tanks, 11-yard tank, 80gpm Roots 827PD blower. New final filter assembly recently installed. Well-maintained with records. \$50,000

Mark 708-475-7100, IL CBM



2005 Vac-Con combination truck, Sterling, auto., tandem axle, hydroexcavation, hi-dump, 12-yd. debris. ... \$55,000 OBO

Call 317-773-7996, IN C05



2003 Mack Elite Vector 2100 Series combo unit: 15-yard debris body, freshly rebuilt engine - less than 1,500 miles. 550hp Cummins ISX non-EGR engine, 15-speed Fuller transmission. New radiator, Jake brake, air-ride cab. High dump, jet rodder, 1" x 500' hose, 80gpm @ 2,000psi. Hydroexcavator 4,000psi, 8' hydraulic boom, Roots 1024 blower. \$109,000 OBO

Kelly 206-619-6809, WA C05



2013 International Vector 2100 Plus: MaxxForce engine 350hp; Allison transmission; 16-cubic-yard debris tank; 1,200-gallon water tank. 32,000 miles; 1,100 PTO hours. Good rubber. Asking \$280,000 OBO

For more info call 631-586-5900, NY C05

2015 Camel Western Star 1200 combo truck, 824 blower, ejector plate, 12-yard debris tank, 80gpm @ 2,000psi water system, 1,500-gallon freshwater, 600' of 1" jet hose. Low hours and miles, some factory warranty left. For pic and more info call Jeff 317-258-4900 (C06)

2015 Freightliner Camel combo truck, 824 blower, ejector plate, 12-yd debris tank, 80gpm at 2,000psi, 1,500-gallon freshwater, 600' of 1" jet hose. Low hours and miles. For more info and pics contact Jeff 317-258-4900 (C07)



2011 Vector 2100/2011 International: 51,000 miles. 6,600 engine hours and 3,200 blower hours. 12-yard debris tank. 16" PD blower. HX kit included. \$175,000

Dave 916-442-5400, CA C05



Vac-Con V-316 Jet-Vac Unit: 3-stage fan, 16-yard body, Cummins power, Myers 2,000psi water pump. Can operate on truck. Ex-municipal unit from Georgia. \$5,750

814-696-4343 C05

2007 Vector: 2013 Sterling chassis, only 38,500 miles. Unit in great condition. \$69,000 OBO. Located in Houston Metro. Contact Jeff 281-770-6714. (C05)

2009 Vector 2103, International chassis, standard transmission, 88k miles, PD blower. \$68,000. Ready to work. Call Bill at 813-489-3108. (C07)

2002 Sterling LT7501 Vac-Con Model V390LHA combination sewer cleaning truck: Freshly painted white. CAT 3126 - 275hp engine, 3-stage fan, 1,000-gallon water tanks, pump off option available. 10' telescopic boom. FMC water pump - 65gpm @ 3,000psi. Articulating hose reel with 600 feet of new 1" hose. 84,316 miles. Located in Orange, CA. \$79,900. Contact Craig: 714-639-8352. Additional details at www.empireequip.com (CBM)

Vac-Con industrial machine mounted on a pre-owned 2006 Sterling cab and chassis. (Stock #8593C) **www.VacuumSalesInc.com (888) VAC-UNIT (822-8648)** (CBM)

Vector 2100 body parts unit with blower on a 2005 Sterling (no engine & transmission) (Stock# 0311V) **www.VacuumSalesInc.com (888) VAC-UNIT (822-8648)** (CBM)

Vac-Con V390LHA combination unit with Roots 827 blower, 1999 International Model 2554 cab and chassis. (Stock #3918C) **www.VacuumSalesInc.com, (888) VAC-UNIT (822-8648).** (CBM)

LEASE/FINANCING

Quick and easy financing for new or used equipment — without all the headaches. **Credit is not an issue.** We have working capital available for commercial equipment purchases \$20,000 to \$2,000,000. **BSG Services** - Call 866-259-5370 or email bsgfin@earthlink.net (CBM)

North Star Commercial Credit: Commercial loans for trucks or equipment. Flexible purchase programs to fit your budget. 21 years in the industry. Contact **Tom Myers** - **877-804-2274.** (CBM)

LOCATORS

Used RIDGID NaviTrack, Gen-Eye Model 100 and Goldak Model 4400. The Cable Center 800-257-7209. (CBM)

MISCELLANEOUS

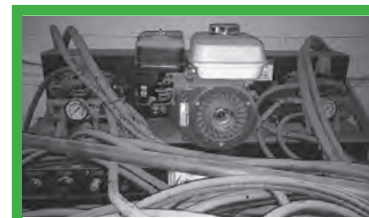

Inflow Solutions rubber seal application system. Contractor equipment pkg., gas engine, pump, 100 ft. of hose and application guns. \$5,000 USD

613-227-8671, ON C05

Manhole Street Cutter - Peco Puller, regarded as the first choice in the industry, 48" diameter w/replaceable teeth. Good condition, used on one project. A video is on website showing entire operation process - www.pecopuller.com. Call for further details. 660-460-0336. (C05)

NOZZLES

SAPPHIRE NOZZLES for UHP, laser-etched, heat treated, excellent quality, fantastic savings! 772-286-1218. info@alljetting.com; www.alljetting.com. (CBM)

PIPELINE REHABILITATION

One trade-in model of Pipe Genie heavy-duty, pipe bursting equipment. Excellent condition, looks new, 30-ton, 100 feet cable, full 2-year warranty. 877-411-7473. (CBM)

MaxLiner CIPP unit: Complete with compressor and heating system. Trailer-mounted. \$6,000 FIRM. 818-231-0417 or 818-704-1413 (C07)

POSITIONS AVAILABLE

CCTV, Laser Profile and Vac-Con operators needed. Busy Florida-based company (established in 1973) looking for experienced underground pipeline inspection applicants with CDL. Full-time, year-round positions to start immediately. Competitive wage based on experience. Call Sean at 239-560-8016 or Donna at 239-267-3344, bring or mail resume to: 2190 Andrea Lane, Ft. Myers, FL 33912. Email sewerone@aol.com. (C10)

Woolpert seeks an experienced CCTV operator to perform push-camera CCTV and small diameter sanitary sewer cleaning assignments. Candidate should be able to operate a CCTV truck and jet-vac truck. Initial work includes overnight shifts, months at a time. Candidates must pass federal background check as required by Federal clients. Please apply online at <https://recruiting.ultipro.com/W001009/JobBoard/97967b39-b3fa-4972-8da3-2af68e0ffa86> (C05)

CCTV Operator needed. 50 to 60 hrs. per week. Work in Florida and South Carolina. CUES and Rausch CCTV. \$19 to \$25 per hr. Call Bill at 813-489-3108. (C06)

Experienced Vector sewer cleaning, CCTV, grout truck operators. Florida, Georgia, Carolinas. Willing to travel, drug tested. Brian 561-234-9533 Ken 706-825-6913 Justin 561-398-1122 (C06)

GapVax, Inc., a nationally recognized manufacturing business, is seeking a talented, highly motivated individual to fill a full-time Sales Position in the Midwest (Iowa based preferred) region. GapVax is the leading manufacturer of industrial and municipal vacuum units and hydroexcavation units in the United States. We provide the most reliable, comprehensive, and efficient mobile vacuum units in the industrial and municipal markets. Specifications of the position are listed on our website, www.gapvax.com, click on the Now Hiring link in the left hand column. Send resumes to Lthomas@gapvax.com or 575 Central Avenue, Johnstown, PA 15902. (CBM)

PRESSURE WASHERS

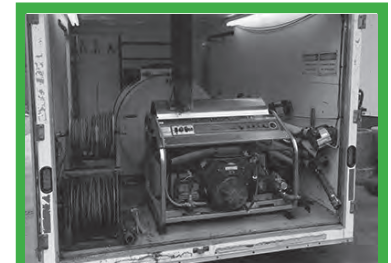

Pressure Washing Trailer: Hydrotek SCU3509VAF dual-gun, hot-water pressure washer. 1,025 hours. 2012 insulated 9990# GVW United trailer. For more info call

304-312-3818, WV C05

PUMPS

Honda model WP40X, 8 hp, 4" with hoses. Honda 4 hp, 2" pump with hoses. The Cable Center: 800-257-7209. (CBM)

New F.E. Myers DP80-20 RH Drive - \$13,529; D65-20 RH Drive - \$12,353. Other models available. Cloverleaf Tool Co. 941-739-0707 www.cloverleaftool.com (CBM)

RENTAL EQUIPMENT

Area/Velocity gravity flow monitor rentals. All inclusive software, rings, sensors, data loggers, \$350 meter/mo. Also have ADS Model#4000 meters and parts for sale. Call Mike 678-900-6805 (C06)

Liquid vacs, wet/dry industrial vacs, combination jetter/vacs, vacuum street sweeper & catch basin cleaner, truck & trailer mounted jetters. All available for daily, weekly, monthly, and yearly rentals. **VSI Rentals, LLC, (888) VAC-UNIT (822-8648) www.vsirentalsllc.com.** (CBM)

SAFETY EQUIPMENT

NEW French Creek, TP7, R50T, MW50G, 7' aluminum fall restraint rescue/retrieval tripod. \$2,000. Call 304-312-3818 (C05)

SERVICE/REPAIR

Dynamic Repairs - Inspection Camera Repairs: 48 hour turn-around time. General Wire, Ratech, RIDGID, Electric Eel Mfg, Gator Cams, Insight Vision, Vision Intruders. Quality service on all brands. **Rental equipment available.** For more info call Jack at 973-478-0893. Lodi, New Jersey. (CBM)

TOOLS

T&T Tools: Probes, hooks. Probes feature steel shafts with threaded and hardened tips. The insulated **Mighty Probe™** tested to 50,000 volts. **Top Poppers™** open man-hole covers easily. Free catalog. **www.TandTtools.com.** Phone 800-521-6893. (CBM)

RIDGID model #300 with stand, RIDGID tri-stand vises, RP 330 ProPress kit. The Cable Center: 800-257-7209. (CBM)

Bosch Brute hammer drill with cart irons. The Cable Center: 800-257-7209. (CBM)

TRAILERS – VACUUM/TANKER

2002 Super Products Camel 3-cubic-yard vacuum trailer with a Roots 412 blower package. (Stock# 0197C) **www.VacuumSalesInc.com (888) VAC-UNIT (822-8648)** (CBM)

Pre-owned 2002 Peterbilt 379 cab and chassis with a 5,460 U.S. Gallon carbon-steel vacuum tank trailer. Complete with a RFL100 vacuum pump package. (Stock# 1193C) **www.VacuumSalesInc.com (888) VAC-UNIT (822-8648)** (CBM)

TV INSPECTION



1998 Ford E450 Cobra Technologies designed camera/television pipe inspection system; 7.5 KW Onan diesel, 120 volt, a/c, 60Hz generator. TV inspection cable reel, crawler assembly, pan/tilt/zoom camera system. 106,000 miles, excellent condition. ... Asking \$60,000

631-586-5900, NY C05



2002 Ford E-450, Night Owl Series camera, fleet maintained, one owner. \$37,950

Call 719-494-4927, CO C05
or visit letsrollautoandequipment.net

Used SeeSnake Camera Systems in all sizes; Used General Wire Spring Camera Systems in all sizes; Used machines in all sizes. We want your trade! The Cable Center: 800-257-7209. (CBM)

CUES sewer televising camera and equipment with a POSM computer operation system. In good working condition, mounted in a F450 gas truck with a 12-foot box. Call 763-444-5501 (C05)

Cyclops CCTV Sewer Inspection Systems is having a sale!! Most items 25% or more off of retail price. This included full systems and parts. Please contact us @ 830-249-9756. (C05)

Used and rebuilt camera kits in stock: RIDGID Mini Compact, Mini Color, Standard Self-Leveling, General Gen-Eye I, II and III, Aries Seeker, and SRECO kits. The Cable Center: 800-257-7209. (CBM)

Pearpoint explosion-proof inspection system, 2000 Isuzu diesel box truck, 16,374 miles, generator 2,670 hours. Two complete Pearpoint Type 420 tractors with Type 494 heads, P599 cable drum, various size light attachments, one spare 494 head, one remote auxiliary counter wheel, spare wheels, brushes, and parts included in tool box. \$39,000. 412-384-9327 (C06)

2008 Ford E-350 RST TV Van: POSM, Omni 3, Washdown system. Approximately 1,200' of single conductor, 5.5 Onan Gen Set, inclinometer. Great shape and READY to make money. Needs nothing. \$68,000 Firm. Dave 214-536-2915 in Dallas area (C06)

2001 Chevy 2500 TV Van: 30,000 miles. RST camera and tractor. POSM software, \$35,000. Pictures upon request @ cdscar@aol.com 916-747-3819 (C05)

Pearpoint Flexi-coiler p571 mk2 pushrod system (attached monitor) with p455 explosion-proof Twinview Flexiprobe color digital camera - auto-uprighting head. Two available. \$13,200 per unit. 412-384-9327 (C06)

WANTED: Grout unit in good condition. 813-677-7655; jerrybaes@aol.com (C06)

NEED TRACTION? We make aftermarket more aggressive pads and chain assemblies for all chain-driven camera tractors. Custom, dependable, double-hole fabrication secured to high quality carbon steel chain, or just pads and rivets. Samples upon request. **Pipe Tool Specialties LLC:** 888-390-6794; Fax 888-390-6670; www.yourtractionpads.com or email pts4422@yahoo.com (CBM)

USED Envirosight ROWVER System: Brand new RC90 camera. Cable reel (SN 360570) has new power supply, motor, clutch, cable (656') and winding rollers. 125 crawler (SN 0260768) has new top plate, side plates, axles and seals, plus new control board compatible with rear-view camera accessory (not included). CCU (SN 0160981) with new power card, new 56V card, new +/-26 card, and new card. Control pendant (SN 0492645) is compatible with RC90 camera and R225 crawler. \$27,500. Call 973-252-6700. (CBM)

1999 CUES Pipe Grout/ Video Inspection Van, rebuilt 10W diesel generator, new video cable. Good working unit. \$32,500. 518-337-9420 (C05)

2004 E350 V8 TV Inspection Truck. 24,547 miles and like-new tires. RST single conductor camera system. Omni II pan-and-tilt zoom color camera with recently rebuilt tractor. Approx. 1,300' of cable. Inclination feature. Locating sonde. POSM software updated in 11/15. Rebuild kit, tools, printer, et al included. Onan CMM7000 generator. Great shape and ready to be used. \$62,500 OBO. John 612-817-6913 Denver (C05)

CUES Camera Cutter Truck, 1999 Ford E450 Super Duty PowerStroke V8. Computer has CUES Granite XP software, 2 pan-and-tilt cameras, 2 kangaroo cutters, Ultra Shorty transporter. Many miscellaneous parts and tools included. Asking \$35,000. 406-447-5050 (C06)

VACUUM LOADERS



2005 GapVax HV56: Articulating boom, 15-yd. debris, hydroexcavation, new engine!, Volvo chassis and engine, Eaton-Fuller transmission, 27" Hibon \$80,000 OBO

317-773-7996, IN C05

WANTED

Wanted: Used US Jetting jetter parts, damaged trailer jet or a jet no longer in service. Specifically looking for 4018 pump or parts, but will consider whole units. Please email usedjetterparts@gmail.com with contact information and what you have available and we will get back to you. (C07)

Wanted to Buy: Vactor 2100s and late model Guzzlers. Cash. 800-336-4369. (CBM)

WATERBLASTING

Gardner Denver T-375M: Bare Shaft pump. Gardner Denver T450M Bare Shaft pump. Gardner Denver TF-375M 21 gpm @ 10,000 psi. Gardner Denver TX-450HB 21gpm @ 20,000 PSI. Gardner Denver TF-450MB 52gpm @ 10,000 psi. NLB 10-200. 34 gpm @ 10,000 psi. HT-150S 25 gpm max 10,000 psi max, Shell Side Machine, Wheatley 165: 30 gpm @ 10,000 psi. Wheatley 125 with aluminum bronze fluid end. Boatman Ind. 713-641-6006. View @ www.boatmanind.com. (CBM)

AIR PREHEATER CLEANER EQUIPMENT FOR SALE. Gardner Denver PCT-2000-P. Two complete systems available. Like new, only used twice. \$19,000 each or \$35,000 for both. 903-758-9166 (C05)

WATER JETTING EQUIPMENT: We sell, repair and retrofit water blasters. Visit us at: www.waterjettingequipment.com or phone 714-259-7700. (CBM)

40,000 psi Sapphire Nozzles, UHP hoses & replacement parts. Excellent quality & prices. 772-286-1218, info@alljetting.com, www.alljetting.com. (CBM)

PLACE YOUR AD ONLINE AT www.cleaner.com – IT'S ALWAYS THERE TO MEET YOUR BUSY SCHEDULE

Wisconsin State Fair Park, Milwaukee, Wisconsin

WEQFAIR

Wastewater Equipment Fair

PRODUCED BY COLE PUBLISHING

SEPT. 12-13, 2016 **MILWAUKEE**

Live demonstrations and operational equipment for the water and wastewater industries!

\$20

per person in advance

\$30

per person on site

Registration includes ear plugs and safety glasses!

MONDAY

September 12th

Fair Hours: 12 p.m. - 6 p.m.

TUESDAY

September 13th

Fair Hours: 8 a.m. - 2 p.m.

Outdoor Event - Rain or Shine



▶ Many hotel options close by: wistatefair.com/wsfp/visitor-information

Pumper installer **PRO**
Cleaner **SEWER WATER** **GAS OIL & MINING CONTRACTOR** **tpo**
digDIFFERENT Plumber

View complete event details at:
WEQFAIR.COM

Call 866-933-2653 for more info.



Pressure Washers, Replacement Engines, Pumps, Parts & Accessories

FLASH SALE

FREE DELIVERY
On Sale Priced Items

NOZZLES

QC 4 PACK



ADJUSTABLE TURBO



ROTATING 4K



UP TO 20 GPM



REPLACEMENTS

TRIGGER 4K



TRIGGER 5K



RECOIL



26.4GPM@1800PSI



ACCESSORIES

JETTER KIT



HYDROEXCAVATION WANDS



SURFACE CLEANER ROLL CAGE FRAMES



WASHERS

HONDA 4200 PSI JETTER



5000 PSI & REEL



HOT WATER



DIESEL HOT WATER



WaterCannon.com

30
YEARS OF SERVICE

1.800.333.WASH (9274)



Industry Trained Staff available from 8:30 a.m. to 7:00 p.m. weekdays E.S.T.

Water Cannon, Un contacto en Espanol: llama al: 1.800.917.9274

Orlando | Phoenix | Minneapolis | Hattiesburg | Melbourne | Toronto | Bogota
International: 1-321-800-5763

Water Cannon
is proud to be a
MWBE



QUALITY & PERFORMANCE

Custom-built industrial vacuum and municipal equipment to meet your needs. Built by the operator, for the operator - we pride ourselves on providing superior service and performance. We also have a full line of parts and accessories.

GapVax has trucks available NOW - Call today or check out our website for the latest inventory.

Schedule a demo today!



www.gapvax.com

TEXAS LOCATION
281-884-8658

GapVax®
HEADQUARTERS
888-442-7829



Spartan Sparshine™ Cable



Cable Ends & Root Cutters



Spartan Model 1065

That's why I buy Spartan!



John Proctor
Cool Blew Plumbing
Serving the Phoenix, AZ area

Why do YOU buy Spartan?

Spartan equipment is built to conquer the toughest clogs - roots, grease, hair - whatever your customers can throw down the drain.



SPARTAN
FOR TOUGH CUSTOMERS.
SINCE 1943

www.SpartanTool.com

The Spartan Advantage

Our Territory Managers come to you.
We provide sales, service & training,
all at your site. Call today to schedule a visit!

800.435.3866

Have a great picture of a root you conquered with your Spartan machine? Send it to us at TellUs@SpartanTool.com.