

# Cleaner

FOR DRAIN AND PIPE CLEANING, INSPECTION AND REHABILITATION PROFESSIONALS

FEBRUARY 2016

  
wwett  
Water & Wastewater Equipment,  
Treatment & Transport Show

SHOW  
ISSUE

## LATERAL PROGRESSION

MINNEAPOLIS CONTRACTOR ADOPTS NEW  
TECHNOLOGY AND SHIFTS BUSINESS FOCUS  
FROM INSTALLATION TO REHABILITATION **PAGE 18**

**WWETT PREVIEW**  
Unwind with Jerrod Niemann

**TECH PERSPECTIVE**  
Understanding pressure and flow

**SAFETY FIRST**  
No excuse for trenching accidents

# Mini-Jet Mini-Price

Starting at just  
**\$975 US**



## Special Introductory Offer

Spray Wand included **FREE**  
with purchase of complete unit.

For more info: [www.drainbrain.com/jets](http://www.drainbrain.com/jets)

You don't always need a heavy duty jetter to clear a clogged drain. General's JM-1000 Mini-Jet™ brings surprising cleaning power to the job. And with its light weight, you'll be blasting away before you could get your big jetter off the truck and into position.

Clear small lines, clogged sinks, and laundry drains from 1-1/2" to 3" in diameter – up to 75 feet long – with 1500 pounds of thrust. Pulse technology helps slide the hose around tight bends and farther down lines.

At only 22 lbs, General's tough Mini-Jet resists job-site abuse, too. The pump and motor assembly are safely contained in a rugged diamond plate metal case.



Pound for pound and dollar for dollar, the Mini-Jet is a great (and small) investment.

For more information, contact the Drain Brains® at General at 800-245-6200 or 412-771-6300, or visit [www.drainbrain.com/jets](http://www.drainbrain.com/jets).



**General**  
PIPE CLEANERS

**The toughest tools down the line.™**



© General Wire Spring 2016



# TERRY: 35,000 FANS, 19 YEARS, LEGENDARY STATUS ACHIEVED.

Because building tough reliable trucks  
takes tough reliable people.

Terry builds these critical components on a fixture he helped design and build. Terry lives out “more power to you” every day. It’s not just our tagline, it’s in everything we do: our technology, our culture, and our leadership. Yes, our trucks are engineered to be powerful, but they’re also built by smart people who keep the end-users in mind. They give you a machine that gets the job done. [GO ON-LINE TO LEARN MORE.](#)

[VAC-CON.COM](http://VAC-CON.COM)

VAC-CON IS A SUBSIDIARY OF HOLDEN INDUSTRIES, INC.. A 100% EMPLOYEE-OWNED COMPANY



A HOLDEN INDUSTRIES Company



THE INDUSTRY'S MOST POWERFUL  
AND DURABLE SEWER TOOLS.

**WARTHOG**  
SEWER NOZZLES BY **STONEAGE**®  
.....  
1-866-795-1586 • [WWW.SEWERNOZZLES.COM](http://WWW.SEWERNOZZLES.COM)

Proudly Manufactured in the USA 



Swap wheels in seconds for an optimized set-up on every run, plus enhanced productivity and easier post-job cleaning.



# FASTER

Enhanced tread patterns and wheel geometry improve traction and clearance, helping you inspect farther.



# FARTHER

Wheels click on securely, and then detach with a simple push of the hub. Never search for tools or fasteners again.



# EASIER

Interlaced rubber tread and improved sidewall contact produce smooth video. Instant wheel release promotes regular cleaning for lower cost of ownership.



# BETTER

Patented Quick-Change wheels are just the latest innovation to reaffirm ROVER X's reputation as the most productive, least complicated system on the market. These wheels now come standard on every ROVER X, and can be retrofitted to existing systems. Ten wheel options are available:



## Envirosight

www.envirosight.com • 973.252.6700



## features

- 18 Profile: Lateral Progression**  
Minneapolis contractor adopts new technology and shifts business focus from installation to rehabilitation.  
By Ken Wysocky
- 32 WWETT Preview: Time to Unwind**  
Country artist Jerrod Niemann ready to give WWETT Show attendees a night of music and fun.  
By Cory Dellenbach
- 36 Profile: The Tools to Succeed**  
Equipment and training key rapid growth for inspection and rehabilitation contractor.  
By Ken Wysocky

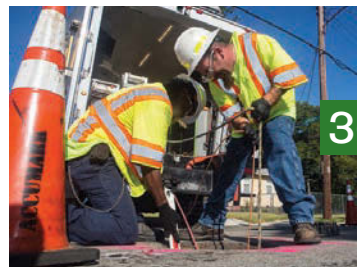

## departments

- 12 From the Editor: Happy to be Back**  
The WWETT Show is the one event that brings the whole industry together.  
By Luke Laggis
- 14 @cleaner.com**  
Be sure to check out our exclusive online content.
- 46 Money Machines: No Water? No Problem.**  
Innovative combo truck is always ready to start working – even with an empty water tank.  
By Ken Wysocky
- 50 Safety First: There's No Excuse for Trenching Accidents**  
Having a trained, competent person at the work site is critical to ensure worker safety.  
By Doug Day
- 56 Better Business: 8 Tips for Effective Delegation**  
Giving your team more responsibility will help your whole operation run smoother.  
By Eric Bloom
- 62 Tech Perspective: Pressure and Flow**  
Determining which water jetter best suits your needs requires some calculated thinking and an eye to the future.  
By Ken Wysocky
- 66 WWETT Spotlight: Mainline Inspection in a Compact Package**  
IRIS robotic crawler camera provides versatile solution for inspecting range of pipe sizes.  
By Craig Mandli
- 70 Money Manager: Whom Should You Trust With Your Money?**  
When it comes to managing your retirement funds, know the differences between a fee-only financial planner and a commission broker.  
By Erik Gunn
- 74 Product Focus: Field and Office Technology**  
By Craig Mandli
- 80 Case Study: Field and Office Technology**  
By Craig Mandli
- 84 Product News**  
Product Spotlight: HammerHead Sidewalker redesign adds convenience, power and speed.  
By Luke LeNoble
- 92 Industry News**

## COMING IN MARCH 2016

### ISSUE FOCUS:

#### Chemical and Mechanical Root Control

- **MONEY MACHINES:** Trailer vac fits into tight quarters
- **SAFETY FIRST:** Free consultations aid compliance
- **MONEY MANAGER:** Make credit cards work for you



### ON THE COVER:

Troy Ouverson grew up installing sewer laterals with his father in suburban Minneapolis. Now he's running the show, and Ouverson Sewer and Water has shifted its focus to rehabilitating many of those same laterals. (Photo by Brad Stauffer)

# TWO SOLUTIONS FOR LATERAL REHABILITATION

wwelt BOOTH 3223

## SOLUTION ONE

### PERMA-LATERAL™ LINING

REHABILITATING RESIDENTIAL HOME LATERALS TO MAIN SEWER. PATENTED TECHNOLOGY.



AFTER

## SOLUTION TWO

INNERSEAL™ REHABILITATING TEE AND WYE CONNECTIONS FROM THE CITY SEWER MAIN TO RESIDENTIAL SEWER LATERALS. PATENTED TECHNOLOGY. MEETS ASTM F2561-11.



AFTER

[www.perma-liner.com](http://www.perma-liner.com)

**PERMA-LINER™**  
**INDUSTRIES, LLC.**

CALL  
**1-866-336-2568**  
TO LEARN MORE





## Hose Handle

Hose and Pipe Handle • One handed tool  
 Snaps on and off hose/pipe easily • Does not conduct heat or cold  
 • High levels of strength and durability



Rain Gear & Boots



Safety Clothing



Hose & Couplings

*We Can Service All Your Needs  
 & ALL In One Place*



Call For A  
**FREE**  
 Catalog  
 Today!

**MRP** 1.800.325.3730  
 MILWAUKEE RUBBER PRODUCTS [www.MilwaukeeRubber.com](http://www.MilwaukeeRubber.com)



*Meeting Our Customers Highest Expectations*



NOZZLES • HOSES • PARTS • ACCESSORIES

Visit our website [www.jetterdepot.com](http://www.jetterdepot.com)

FAIR PRICES • QUALITY SERVICE • GUARANTEED

770 406 8248 • 678 431 8136

## TRYTEK 3" to 6" Lateral Cutter

### NEW! TRYDENT 80 Cutter System

- > For interior or exterior relined pipes
- > Access pipe systems through clean-out ports or rooftop vents
- > Navigate standard 90 degree elbows in 3" pipe
- > Includes 100' of hose reach



[www.trytek.com](http://www.trytek.com)

Contact us for more information:  
 Phone: 717-428-1477  
 Fax: 717-428-2865  
 Email: [trytek@trytek.com](mailto:trytek@trytek.com)  
 250 N. Main St.  
 Jacobus, PA 17407 USA

Serving the  
 industry for over  
**25 years**

## Cleaner

FOR DRAIN AND PIPE CLEANING, INSPECTION AND REHABILITATION PROFESSIONALS

Published monthly by COLE Publishing, Inc.

1720 Maple Lake Dam Rd., PO Box 220, Three Lakes, WI 54562

Call toll-free 800-257-7222 | Outside of U.S. or Canada call 715-546-3346

Mon-Fri, 7:30 a.m.-5 p.m. CST

Website: [www.cleaner.com](http://www.cleaner.com) | Email: [info@cleaner.com](mailto:info@cleaner.com) | Fax: 715-546-3786

**SUBSCRIPTION INFORMATION:** A one year (12 issue) subscription to *Cleaner* in the United States or Canada is free to qualified subscribers. A qualified subscriber is any individual or company in the United States or Canada that is involved in the inspection, cleaning, repair and installation of residential and commercial sewer lines. Non-qualified subscriptions are available at a cost of \$60 per year in the United States and Canada/Mexico. Subscriptions to all other foreign countries cost \$80 per year. To qualify, visit [www.cleaner.com/order/subscription](http://www.cleaner.com/order/subscription) or call 800-257-7222.

Our subscriber list is occasionally made available to carefully selected companies whose products or services may be of interest to you. Your privacy is important to us. If you prefer not to be a part of these lists, please contact Nicole at [nicole@colepublishing.com](mailto:nicole@colepublishing.com).

**CLASSIFIED ADVERTISING:** Submit classified ads online at [www.cleaner.com/classifieds/place\\_ad](http://www.cleaner.com/classifieds/place_ad). RATE: No Photo Classified \$25 for 20 words, each additional word \$1. All classified advertising must be PAID IN ADVANCE. DEADLINE: Classifieds must be received by the first of the month for insertion in the next month's edition. PHONE-IN ADS ARE NOT ACCEPTED. Ads may be faxed only when charging to MasterCard, VISA, Amex or Discover. Please supply all credit card information with faxed ads. Be sure to include your phone number (with area code) in your ad. Make checks payable to COLE Publishing Inc. and mail with classified ad to the address above. CLASSIFIED ADVERTISING APPEARS NATIONWIDE AND ON THE INTERNET. Not responsible for errors beyond first insertion.

**DISPLAY ADVERTISING:** Contact one of our sales staff at 800-994-7990. Publisher reserves the right to reject advertising which in its opinion is misleading, unfair or incompatible with the character of the publication.

**REPRINTS AND BACK ISSUES:** Visit [www.cleaner.com](http://www.cleaner.com) for options and pricing. To order reprints, call Jeff Lane at 800-257-7222 (715-546-3346) or email [jeffl@colepublishing.com](mailto:jeffl@colepublishing.com). To order back issues, call Nicole at 800-257-7222 (715-546-3346) or email [nicole@colepublishing.com](mailto:nicole@colepublishing.com).

**CIRCULATION:** Circulation averages 26,460 copies per month. This figure includes both U.S. and international distribution.

© 2016 COLE Publishing Inc.

No part may be reproduced without permission of the publisher.



Kayla Bisnette Jim Koshta



GET  
 SOCIAL  
 WITH  
 Cleaner

- [www.facebook.com/CleanerMag](http://www.facebook.com/CleanerMag)
- [www.twitter.com/CleanerMagazine](http://www.twitter.com/CleanerMagazine)
- [www.plus.google.com](http://www.plus.google.com)
- [www.youtube.com/CleanerMagazine](http://www.youtube.com/CleanerMagazine)
- [www.linkedin.com/company/cleaner-magazine](http://www.linkedin.com/company/cleaner-magazine)



### WATER & WASTEWATER EQUIPMENT, TREATMENT & TRANSPORT SHOW

EDUCATION DAY: Feb. 17, 2016  
 EXHIBITS OPEN: Feb. 18 - 20, 2016

Indiana Convention Center  
[WWW.WWETTSHOW.COM](http://WWW.WWETTSHOW.COM)



©2016 RIDGID, Inc. The Emerson logo and RIDGID logo are registered trademarks of Emerson Electric Co. in the U.S. and other countries. All other trademarks are the property of their respective holders.

# INSPECT. REPORT. DONE.

CREATE AND DELIVER DETAILED INSPECTION REPORTS ON THE JOB WITH THE RIDGID® CS65 DIGITAL REPORTING MONITOR.

DUAL USB DRIVES

FULLY INTEGRATED  
KEYBOARD

1TB INTERNAL  
HARD DRIVE



★ SEE HOW IT WORKS OR REQUEST A FREE ONSITE DEMO AT [RIDGID.COM/CS](http://RIDGID.COM/CS) | 800.769.7743 ★



**A**

A Corp/Rooter-Man .....72

A.R. North America, Inc. ....80

**ALLAN J. COLEMAN**  
SINCE 1905

Allan J. Coleman Co. .... 41, 83

**AMAZING MACHINERY**

Amazing Machinery, Inc. ....51

**AQUA MOLE**  
TECHNOLOGIES

Aqua Mole Technologies, Inc. ....82

Arctic Blasters, Inc. ....44

**ARIES INDUSTRIES, INC.**

Aries Industries, Inc. ....31

Arthur Products Co. ....44

**B**

BODUS GmbH .....54

**C**

Cable Center, The ..... 58, 101

**CAM**

Cam Spray .....52

**FAT PUMPS**

Cat Pumps .....39

**CENTRAL OKLAHOMA WINNELSON**

Central Oklahoma Winnelson .....68

**CIPP SERVICES, INC.**

CIPP Services, LLC .....43

**CLOVERLEAF TOOL CO.**

Cloverleaf Tool Co. ....60

**TORQUEMASTER**  
THE PROFESSIONAL'S CHOICE

Coast Manufacturing .....64

**CUES**

CUES .....35

**D**

Doug Meadows Co., LLC. ....48

**DRAINABLES DIRECT**

Drainables Direct .....77

**DURACABLE**  
Manufacturing Company

Duracable Manufacturing Co. ....55

Dyna Flex, Inc. ....11

**E**

**Electric Eel**

Electric Eel Mfg. ....44

**Envirosight LLC**

Envirosight, LLC .....5

**enz usa inc.**

Enz USA, Inc. ....60

**F**

**Solutions**

F. S. Solutions ..... 59, 82

Forbest Products Co. ....79

**G**

**GapVax**

GapVax, Inc. ....103

**General PIPE CLEANERS**

General Pipe Cleaners .....2

**GORLITZ SEWER & DRAIN, INC.**

Gorlitz Sewer & Drain, Inc. ....67

**GUZZLER**

Guzzler Manufacturing .....13

**H**

Hammelman Corp. ....95

**HammerHead**

HammerHead Trenchless Equip. ....91

**Hannay Reels**  
The reel leader

Hannay Reels .....21

Harben, Inc. ....69

**HATHORN**

Hathorn Corporation .....64

**J**

**Jetstream**

Jetstream of Houston ..... 25, 65

Jetter Depot .....8

**K**

**Ken-Way**

Ken-Way Corporation .....42

**L**

**Lansas**

Lansas Products .....22-23

LaPlace Equipment Co. ....90

**Liberty Financial**

Liberty Financial Group .....42

**LMK TECHNOLOGIES**

LMK Technologies .....85

Logiball, Inc. ....58

**M**

**MAXLINER**

MaxLiner USA .....17

**MRP**

Milwaukee Rubber Products, Inc. ....8

**Mongoose JETTERS**

Mongoose Jetters by Sewer Equipment ...89

**MyTana**

MyTana Mfg. Company, Inc. ....93

**N**

**NLB Corp.**

NLB Corp. ....49

**NozzTeq**  
Taking Science To The Streets

NozzTeq, Inc. ....94

Nu Flow .....97

**O**

**OceanQuip LLC**  
WHERE THERE'S A CALL

Oceanquip Cables, LLC .....52

**P**

**PERMA-LINER INDUSTRIES**

Perma-Liner Industries, LLC .....7

Petersen Products Co. ....82

**PICOTE**

Picote Solutions. ....90

**Pipeline Analytics**

Pipeline Analytics .....48

Pipeline Renewal Technologies .....53

**PIPELOGIX**

PipeLogix, Inc. ....63

Piranha Hose Products .....30

Pow-r-Mole Sales LLC .....52

**PRIMELINE**

PrimeLine Products, Inc. ....26

**Pulsar 2000**  
Line Tracer

Pulsar 2000, Inc. ....68

**Q**

Quik-Lining Systems, Inc. ....64

**R**

**RS**  
THE SINGLE SOLUTION

R.S. Technical Services, Inc. ....47

**RapidView IBAK**

RapidView IBAK North America .....87

**Ratech ELECTRONICS**

Ratech Electronics, Ltd. ....75

RauschUSA .....71

**REELCRAFT**

Reelcraft Industries, Inc. ....26

**RIDGID**

RIDGID .....9

**Root Rat**

Root Rat .....90

**ROOTX**

RootX .....27

Rush-Overland Manufacturing .....57

**S**

**SCOOTER**

Scooter Video .....61

Sensoray .....12

Sewer Equipment Co. of Nevada .....48

**SOUTHLAND TOOL, INC.**

Southland Tool Mfg., Inc. ....45

**SPARTAN**

Spartan Tool, LLC .....104

**STONEAGE**

StoneAge, Inc. ....4

Supervac 2000 .....16

**T**

**T&T TOOLS**

T&T Tools, Inc. ....34

Trenchless Solutions, Inc. ....60

Trojan Worldwide, Inc. ....72

**TRYTEK**

TRY TEK Machine Works, Inc. ....8

TST Sweden AB .....33

**U**

**ultraSHORE PRODUCTS**

Ultra Shore .....94

**US JETTING**

US Jetting, LLC .....81

USB - Sewer Equipment Corporation .....34

**V**

**VAC-CON**

Vac-Con, Inc. ....3

**VACALL**

Vacall - Gradall Industries .....73

Vacuum Truck Rentals .....30

**VARCO**

VARCO .....16

**VIVAX METROTECH**

Vivax-Metrotech Corp. ....15

VSI Rentals. ....54

**W**

**WATER CANNON**

Water Cannon, Inc. - MWBE .....102

Westmoor Ltd. ....30

**Marketplace..... 96-97**

**Classifieds.....98-100**

**Cleaner**

Have you seen the Cleaner E-Zine?

Go to **cleaner.com** to view the e-zine.

# HIGHER STANDARDS

## DYNA FLEX SEWER CLEANING HOSE

**FREE SHIPPING IN THE U.S.!!**  
Excludes Alaska & Hawaii

**FREE WOOD REEL!!**

**FREE MALE PIPE SWAGE FITTING!!**

**FREE MENDER!!**



	<b>1" 2500 PSI ORANGE W/ MALE PIPE BOTH ENDS</b>	<b>1" 3000 PSI BLUE W/ MALE PIPE BOTH ENDS</b>
<b>500 FT</b>	<b>\$1095.00</b>	<b>\$1195.00</b>
<b>600 FT</b>	<b>\$1295.00</b>	<b>\$1395.00</b>
<b>800 FT</b>	<b>\$1695.00</b>	<b>\$1795.00</b>

PROMO CODE: **CLEANER**  
OFFER GOOD THRU March 31, 2016

**EXCELLENT QUALITY ..... 2-BRAID CONSTRUCTION .....  
BONDED TUBE & COVER ..... ABRASION & KINK RESISTANT WITH SLICK SURFACE**

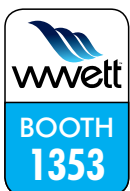

**DYNA FLEX**  
INCORPORATED

Phone: 800-525-8463

Website: [www.DynaFlexInc.com](http://www.DynaFlexInc.com)

Made In The USA



Luke Laggis  
editor@cleaner.com

# Happy to be Back

The WWETT Show is the one event that brings the whole industry together

By Luke Laggis

**W**elcome to the 2016 Water & Wastewater Equipment, Treatment & Transport (WWETT) Show issue of *Cleaner*. I hope you're gearing up for Indy and are excited to take in everything the show has to offer.

We've gone back to our Wednesday-through-Saturday schedule to make it easier for you, and we've added new components to make the show even better. It's the biggest show we've ever put on, and I think it's going to be the best you've ever attended.

I can remember how impressed I was with the size and scope of the show floor on my first trip to Indy, but after five shows, I realize it's not the trucks and equipment that make it so impressive. It's the people. I'm looking forward to talking to as many of you as possible, getting your feedback, listening to

the issues you're facing, and hearing your stories. Of course, I'm excited to check out all the new tools, trucks and equipment, too, but it's really your stories I'm interested in.

This is an industry with a surprisingly high level of technology and innovation, yet it's also one driven by so many small family businesses. I enjoy that facet of this industry, and I appreciate that sometimes it's the mom-and-pop shops that figure out how to build a better mousetrap.

That's part of what makes the WWETT Show such a great experience — seeing mom and dad and the kids, all dressed in matching company shirts, checking out new state-of-the-art inspection equipment or kicking the tires on a half-million-dollar hydroexcavator. You don't see that everywhere, and it's a big part of what makes this whole industry such a close-knit family.

That family atmosphere will be on display all week. Whether you're in your hotel, the convention center or out to dinner, you'll have no problem striking up conversations with your peers. So take advantage — the insight you gain could help you solve a recurring problem or chart an entirely new course for your business.

You'll have plenty of opportunities to help your business while you're in Indy. You'll also have plenty of opportunities to relax and enjoy yourself. Make sure all of the following are on your itinerary:

**Education Day.** You don't have to spend all day in the classroom, but be sure to pick out at least a couple classes that address questions, areas of interest or new opportunities you've been eyeing. The level of instruction is excellent, and knowledge is good for business.

**Kickoff Party.** Get on the dance floor! No, it's not that kind of party, but there will be free food and drinks. And you'll be able to hang out and chat with some of the smartest people in the industry. That's a nice (and productive) way to cap off Education Day.

**Walking the floor.** OK, this one is obvious, but make sure you see everything on the show floor. You don't know where you might find inspiration or the next big profit generator for your business, and there's some pretty cool stuff to see.

**Sewer History Exhibit.** Get a look at where it all began. NASSCO and the Arizona Water Association brought their Sewer History Exhibit to the show for the first time last year, and it's back again. It's an impressive display of early ingenuity and a great look at how far the industry has come.

**Industry Appreciation Party.** Jerrod Niemann is playing. And beer only costs a quarter. Enough said. Don't miss out.

It's not easy to boil the whole week down to a few items on your itinerary, and really, why would you want to? There's so much more to see and do. Take it all in, and enjoy the show.

Welcome to Indy! **C**

## Embeddable DVR

### FEATURES

- Records to two USB devices simultaneously
- JPEG snapshots without video interruption
- Customizable user interface
- Real-time clock with battery backup
- Optional Wi-Fi streaming

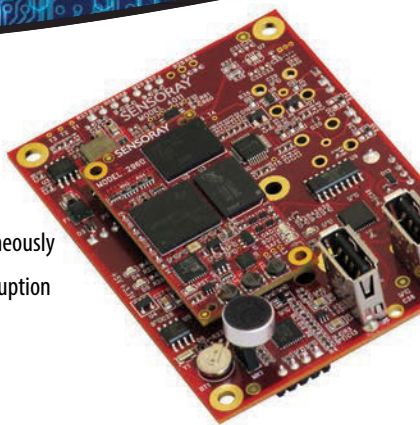

**Sensoray's Model 4011** is a compact Digital Video Recorder (DVR) designed to be easily embedded in OEM products. Record video and audio to USB storage media, and output live or recorded video to a monitor. Made in the U.S.A.

**SENSORAY** | embedded electronics

www.sensoray.com



# Your Guzzler comes with a pit crew

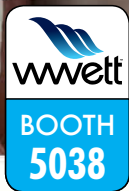

When you buy a Guzzler®, you get more than the toughest, most reliable industrial vacuum truck in the business. You also get the full backing of the Guzzler team – for parts and service, round-the-clock support, training, consulting and industry expertise. Think of us as the pit crew dedicated to taking care of you and your truck. We can even help you expand your business by exploring new markets and applications for your Guzzler truck. With your Guzzler pit crew, the competition can eat your dust.

Guzzler is a registered trademark of Guzzler Manufacturing.  
©2015 All Rights Reserved.

**For a demo or to meet your Guzzler pit crew,  
call 800-627-3171 or visit [www.guzzler.com/pitcrew](http://www.guzzler.com/pitcrew).**

*Guzzler products are serviced and supported by FS Solutions<sup>SM</sup>*

# @Cleaner.com

Visit the site daily for new, exclusive content. Read our blogs, find resources and get the most out of *Cleaner* magazine.



## DO YOUR HOMEWORK

### 4 Questions to Consider When Choosing an Inspection System

Pipe inspection and locating systems represent a significant investment for most small businesses. Choosing the right system for your needs is a task that should be taken with a serious attention to detail to avoid a costly mistake.

[>>cleaner.com/featured](http://cleaner.com/featured)



## MOBILE MARKETING

### A Nice Van Can Boost Your Brand

You don't get a second chance to make a good first impression. Building a recognizable brand with a positive image is important, and it's often the difference between a new customer calling you or your competitor. "Nowadays, it's all how you present yourself," says Dickenschrauf Plumbing Solutions co-owner Ryan Schraufnagel.

[>>cleaner.com/featured](http://cleaner.com/featured)

## OVERHEARD ONLINE

“It used to be you had the old guy that ran the truck, and he was very good at teaching the new guy. It seems we've fallen into this rut where we just push buttons, and we don't put hands on things anymore; it's made a big difference on how proper maintenance is handled.”

— Hands-On Jetter Hose Maintenance

[>>cleaner.com/featured](http://cleaner.com/featured)



FLU SEASON AHEAD

## ILL PREPARED

### How to Handle Employees Calling in Sick

The problem of absenteeism and lost productivity is a reality that all businesses must deal with, but it can be especially costly for small- to mid-sized sewer and drain cleaning contractors. Learn how effective communication can cut down on employees abusing sick leave policies. [>>cleaner.com/featured](http://cleaner.com/featured)



## Emails and Alerts

Visit [Cleaner.com](http://Cleaner.com) and sign up for newsletters and alerts. Get exclusive content delivered right to your inbox and you'll stay in the loop on topics important to you!

## Join the Discussion



Find us on Facebook at [facebook.com/CleanerMag](http://facebook.com/CleanerMag) or Twitter at [twitter.com/CleanerMagazine](http://twitter.com/CleanerMagazine)

# VIVAX

---

# METROTECH

**With the vCam camera series inspect lines from 2 to 8 inches and lengths up to 400 feet. Trace and locate lines with the built in sondes and traceable pushrod as standard equipment.**

## ***vCamMX Mini Inspection System***

- Over 5 hours of battery life
- Daylight viewable 8 inch display
- Portable lightweight all-in-one system
- Interchangeable 0.70" and 1" cameras



## ***vCam-5 Inspection System***

- 5 hour battery life
- 300GB internal hard drive
- Daylight viewable 8 inch display
- Compatible with LACP software



## ***vLocPro2 Locator***

- Long battery life
- Lightweight and ergonomic
- Bluetooth and GPS options
- Full utility locating with additional transmitter



**Loc-5Tx**

**Call us for your no obligation on-site demonstration!**

**Vivax-Metrotech Corporation**

3251 Olcott Street  
Santa Clara, CA 95054, USA

Toll Free: 800-446-3392  
Fax: +1-408-734-1415

Email: [sales@vxmt.com](mailto:sales@vxmt.com)  
[www.vivax-metrotech.com](http://www.vivax-metrotech.com)



## NEW MANUFACTURING FACILITY

- + Increased production capacity
- + On time delivery
- + Custom engineered and manufactured

Toll free 866 839-5702

[www.supervac.co](http://www.supervac.co)



**ENGINEERED FOR HIGH PERFORMANCE**



**ORDER TOLL FREE 866-872-1224**

SHOP 24 HOURS A DAY 7 DAYS A WEEK ONLINE AT [WWW.VARCOPIUMPER.COM](http://WWW.VARCOPIUMPER.COM)



**SOURCE KEY 02C16**



**NEW VARCO JETTERFLEX**

**PREMIUM PIRHANA SEWER HOSE**



**Comes on Plastic Reel - For No Extra Charge! No Cardboard to Get Wet!**  
Smaller sizes and lengths do not come on reel - check with your customer service rep for details.

## VARCO LATERAL LINE/WATER JETTER HOSE

VARCO Branded and MADE IN THE USA;

We get it for cheaper, so we can sell it for cheaper.

- Lateral line hose has become the standard for the septic industry.
- Polyether-urethane cover provides exceptional cut, abrasion and fungus resistance.
- Sizes from 3/8" up to 1", Working pressures up to 4800psi.

### PREMIUM PIRHANA SEWER HOSE

	DESCRIPTION	500 ft	600 ft
3/4"	Premium Pirhana Orange 2500psi	\$1,095.00	\$1,314.00
1"	Premium Pirhana Orange 2500psi	\$1,285.00	\$1,540.00
3/4"	Premium Pirhana Blue 3000psi	\$1,154.00	\$1,385.00
1"	Premium Pirhana Blue 3000psi	\$1,485.00	\$1,780.00

### NEW VARCO JETTERFLEX LATERAL LINE / JETTER HOSE

4000 psi rated • Safety Green - Pressure Tested • Precoupled assemblies MXM pipe thread fittings

**\*3/16" ON CLOSEOUT SPECIAL - SAVE 25%**

	50'	75'	100'	150'	200'	250'	300'	350'	400'	450'	500'	550'	600'
1/8"	\$15.28	\$21.25	\$26.38	\$37.49	\$48.60	\$56.74	\$66.88	\$77.02	\$87.15	\$97.31	\$107.45	\$117.58	\$127.72
3/16"*	\$21.23	\$26.95	\$33.60	\$44.89	\$56.84	\$68.80	\$80.75	\$92.71	\$104.66	\$116.63	\$128.58	\$140.54	\$152.50
1/4"	\$29.85	-	\$55.85	\$81.82	\$107.77	\$126.38	\$150.52	\$174.65	\$198.77	\$222.89	\$247.02	\$271.15	\$295.28
3/8"	\$62.08	\$91.28	\$105.54	\$151.12	\$215.06	\$259.57	\$304.05	\$347.48	\$382.09	\$425.75	\$469.43	\$513.11	\$556.77
1/2"	-	-	\$186.69	-	\$353.97	-	\$505.85	-	\$660.02	-	\$815.97	-	\$972.66





# MAX PERFORMANCE.

**Max out your capabilities with our complete CIPP solution:**

- High performance resins that are economical and ecologically-friendly
- Compact equipment for laterals, verticals and hard-to-reach pipes
- Supplies, liners and resins made by the world's leading manufacturers
- Quality felt liners that curve, stretch and accommodate up to 90° bends
- Custom solutions with 4-6" transitions for any liner length or complexity

**MAXLINER**



VISIT WWETT BOOTH #1160



276.656.1225

[maxlinerusa.com](http://maxlinerusa.com)

MINNEAPOLIS CONTRACTOR ADOPTS NEW TECHNOLOGY AND SHIFTS BUSINESS FOCUS FROM INSTALLATION TO REHABILITATION

# LATERAL PROGRESSION

BY KEN WYSOCKY | PHOTOGRAPHY BY BRAD STAUFFER

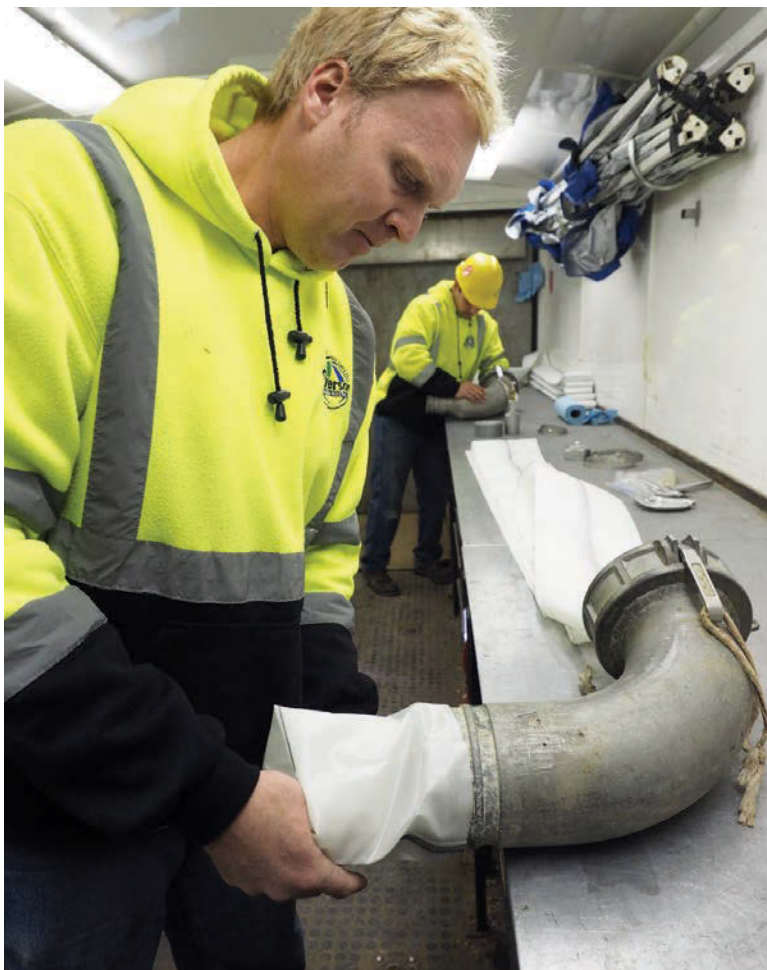

Ouverson Sewer and Water owner Troy Ouverson prepares a calibration tube inside his lining trailer before rehabilitating a residential lateral line.

DOUG OUVERSON CAPITALIZED ON WESTERN MINNEAPOLIS' DECADES-LONG SUBURBAN HOUSING BOOM BY BUILDING A COMPANY FOCUSED ON LATERAL LINE INSTALLATION. TODAY, HIS SON, TROY, NOW THE OWNER OF OUVERSON SEWER AND WATER, CONTINUES TO BUILD ON THE FAMILY LEGACY BY LINING MANY OF THE SAME LATERALS HIS FATHER INSTALLED YEARS AGO.

The irony isn't lost on the younger Ouverson, age 36, who took over the business in 2007 when his father retired. At that point, the company's business focus took a sharp 180-degree turn. Instead of primarily installing laterals for new houses, the company embraced trenchless technology and began spot-repairing and lining failing laterals.

The Ouversons' business U-turn underscores the importance of keeping up with technological advancements and spotting potential markets in which to apply them. In addition, it reflects the benefits of taking calculated risks based on a combination of sound research and gut instinct.

In another ironic twist, it was the elder Ouverson, not Troy, who strongly advocated for the change. "We saw lateral spot-repair technology at a trade show, and it was funny because Dad said, 'What a great idea,'" Ouverson recalls. "You'd think it would've been the other way around. I thought it involved too much messing around.

"But on the other hand, I could see what was going on in Minneapolis, where infrastructure needed rehabbing," Ouverson says. "Dad was also fed up with the cutthroat pricing — always doing more work for less money — and the cyclical market swings in new housing. So we figured it was time to make a change and get into pipe lining."

Ouverson Sewer and Water technician Scott Theisen (left) feeds a MyTana MY30CSL inspection camera into a lateral line while Troy Ouverson watches its progress on the monitor.



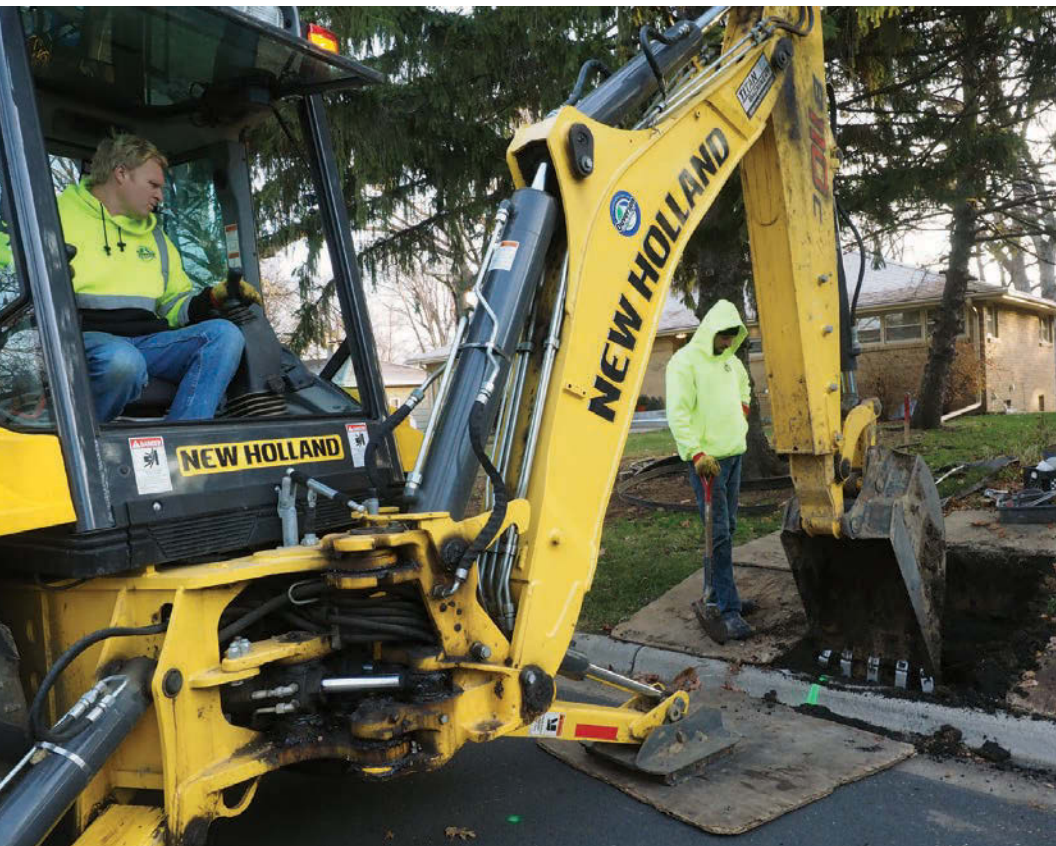

◀ LEFT: Troy Ouverson digs an access pit for a lateral lining job with a New Holland TLB excavator.

ABOVE: David Allen unloads equipment from the lining trailer at a residential job site. The equipment includes a Dewalt air compressor, a MyTana MY30CSL Professional Video Inspection camera, a Perma-Liner Stinger Mini Steam Cure Unit, and a Boss Air 70 cfm air compressor.

In a perfect example of the old adage that timing is everything, the company made the switch in 2007, just before the deep recession hit full-force. “Kind of by luck, we got out just before the new-home market crashed,” Ouverson notes. Today, nearly all of the company’s revenue comes from lateral repairs and lining.

profile

## OUVERSON SEWER AND WATER INC., MINNEAPOLIS, MINNESOTA

FOUNDED: 1969

OWNER: Troy Ouverson

EMPLOYEES: 4

SPECIALTIES: Residential lateral lining and repair

SERVICE AREA: Minneapolis west metro area

WEBSITE: [www.linemysewer.com](http://www.linemysewer.com)



### STEEP LEARNING CURVE

For decades, even with cyclical ups and downs, the installation business seemed as solid as a cast iron lateral line. “When my dad started out, there were many subdivisions converting from septic systems to sewers, so there was high demand for lateral installations for existing homes, as well as for new homes,” Ouverson recalls. “It was a very promising market; it seemed like it would never end.”

But when it did, the Ouversons’ adoption of new technology positioned the company to survive. It was not, however, an easy transition. “It was really



Ouverson’s 2015 Ford F-450 box truck leaves the company’s Loretto, Minnesota, headquarters pulling the 24-foot lining trailer.

Technician Matt Allen carries gear back to Ouverson's lining trailer on a job site in Crystal, Minnesota.



difficult,” Ouverson says. “My dad and I had worked together for all those years. ... Everything was easy for us. He’d been doing it forever and I’d been tagging along with him since I was 12 years old. We didn’t need to talk about things while working; I knew what his move was and he knew my move without speaking a word.”

Getting the hang of pipe lining was a different story; the learning curve was steep. Many times, Ouverson says, he and his father didn’t get back from jobs until midnight because a pipe liner didn’t cure out as fast as they expected. That wasn’t the fault of the system they used, made by

“At the time, customers were dumbfounded that this technology was available. It wasn’t that tough a sell. The product sells itself — it really does.”

Troy Ouverson

Perma-Liner Industries, he emphasizes. Instead, it was a factor of not realizing that each job required different applications, such as using the correct resins for various air temperatures.

“Say it’s 90 degrees outside and you need to leave plenty of time to wet-out the liner,” Ouverson explains. “Then you put it in the pipe, where it’s maybe only 57 degrees. Now you have hot resin in a cool pipe, so it takes a lot longer to cure. At times, some jobs took seven hours to cure out. After a year, I thought I felt comfortable shooting liners. But looking back now and being more realistic, I’d say it took about three or four years.”

The company uses Perma-Liner technology for lining long pipe runs; for spot repairs, it uses a system made by RS Technik. Crews perform liner wet-out operations in a 24-foot cargo trailer made by Interstate Cargo Group, towed by a 2015 Ford F-450 equipped with a Knapheide Mfg service body.

In addition, the company owns four mainline pipe inspection cameras and one mini-camera made by MyTana Mfg. Company; a 2012 Isuzu NPR service truck featuring a box body made by Delta-Waseca; a tractor/loader backhoe built by New Holland and carried on a 24-foot Towmaster flatbed trailer; a 1998 International 4800 with a J-Craft dump box; two large drain cleaning machines (for 4- and 6-inch pipes) made by General Pipe Cleaners; and a 2013 Ford Econoline service van.



# THE REEL THAT WORKS AS HARD AS YOU

When it comes to your equipment, you demand quality and value – and Hannay Reels delivers every time.

Pressure ranges from 300 PSI up to 10,000 PSI

Heavy-duty ribbed discs and one-piece axle hub assemblies

Low, hassle-free maintenance

Reels built to order with fast delivery

Come to the Hannay Booth #5027 at the 2016 WWETT Show, February 17–20, and register to win a GH1100 portable hose reel on wheels from Hannay Reels.



Find your local dealer: [hannay.com](http://hannay.com) or 877-467-3357

## GROUND BREAKING TECHNOLOGY

On the plus side, it was easy to convince customers that trenchless lateral rehab was a superior option to open-cut repairs. “At the time, customers



**Hannay Reels®**  
The reel leader.



Technicians David Allen (left) and Matt Allen set up for the preliminary cleaning and inspection of a lateral line before repairing it with CIPP.

“If you’re a carpenter and you cut a two-by-four wrong, you just go and grab another one. But if you make a mistake while lining a pipe under a highway, you end up excavating under a highway (to repair a mistake), and it takes a lot of jobs to make up for that one mistake.”

Troy Ouverson

were dumbfounded that this technology was available,” Ouverson says. “It wasn’t that tough a sell. The product sells itself — it really does.”

The immediate appeal: no yard excavation or ripped-up landscaping. In addition, unless a customer has a small yard with no trees, sidewalks or other obstructions, pipe lining is generally less expensive than pipe replacement, he explains.

Competition was fierce early on as other contractors also decided to get into pipe lining. That resulted in project bidding wars, which eroded profit margins. Determination to do jobs right is what set Ouverson apart. “We always feel like we should do a job the way we’d do it for ourselves,” he says. “We’re still like that. We do the job right, no matter what it takes.”

After the recession, many competitors dropped pipe lining and either went back to what they did before or opted to enter completely different markets. The fact that Ouverson remained illustrates the importance of hiring good employees and giving them proper training. “People didn’t realize how important it was to have a good lead person and a good crew,” Ouverson says. “If you’re a carpenter and you cut a two-by-four wrong, you just go and grab another one. But if you make a mistake while lining a pipe under a highway,

**lansas<sup>®</sup> PRODUCTS**  
 Manufactured by Vanderlans & Sons, Inc.



**SUPER FLOW™**

The Lansas Super Flow Plugs will allow you to bypass or control up to 90% of the pipe line flow.

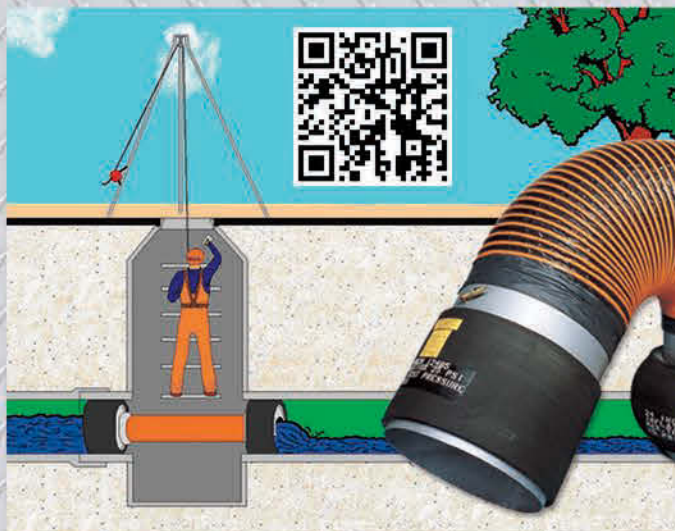

**SINGLE-SIZE TEST PLUG (SST)**



The SST is used to stop or bypass pipeline flow, also great for air testing.



# CHALLENGES PROVE THE VALUE OF SKILL, DETERMINATION ... AND LUCK

Early last summer, Troy Ouverson — the owner of Ouverson Sewer and Water, a pipe lining and repair company in Minneapolis — encountered a job that tested his employees' skill and mettle.

The problem: a ruptured 4-inch-diameter residential lateral line that apparently had been leaking for years. For starters, the lateral configuration was unusual, to say the least. Two lateral lines — one running from each of two adjoining houses — merged inside a private manhole, then continued as one pipe from there out to the main sewer line. "In all, there was a total of 400 feet of pipe," Ouverson says, noting that the laterals were made out of asbestos-cement, then switched to 6-inch-diameter clay pipe from the curb to the mainline.

The leak was so bad that raw sewage was actually bubbling up through cracks in the street. "The soil was saturated with raw sewage that had never made it to the mainline for years and years — it was just leaching into the surrounding sandy soil," he says. "One of the homeowners discovered the leak only because a friend had dumped waste from an RV into the manhole, which apparently was too much for the system to handle."

To try to save the customer money, Ouverson felt obligated to first try lining the lateral, which was leaking at every elbow joint from the manhole to the mainline — including one that was so badly deteriorated that he feared it would not allow the liner to pass. The fact that the mainline was 22 feet deep only added to the project's complexity.

"I was nervous because this one 90-degree elbow was so broken up that I didn't think the liner would get through," he recalls. "But somehow — I don't know how — it could not have turned out better. Both homeowners were out there and they applauded when we finished shooting the line. It was a big deal to them."

The Ouverson crew arrived on the job at 7 a.m. They finally closed up the street after midnight. "We felt we could not leave those two houses without sewer service overnight," Ouverson says. "I always ask the guys if they want to finish a job that day or go home and finish the next morning. But we're usually on the same page: 'Let's get this done.'"

"In this case, we were really determined to finish the job that night," he adds. "No one said, 'Come on, it's 8 o'clock at night — let's just go home.'"

In the end, the depth of his employees' experience carried the day, Ouverson says. That and a little bit of good luck.

## MULTI-SIZE INTERCHANGE PLUG™

The Interchange Plug can be equipped with a threaded, flange, or superflow connection to make your by pass job clean and simple.



## FLOW-THRUST™



The Lansas Multi-Size Flow-Thru™ can be manufactured with nitrile or neoprene rubber and stainless steel components for use in chemical and petroleum applications.

*Custom Designs  
Are Always™ Available*

**VANDERLANS AND SONS, INC.**

California 1-800-452-4902

Atlanta 1-770-509-9309

Chicago 1-800-452-4902

Houston 1-832-831-4458

[www.lansas.com](http://www.lansas.com)





The Oувerson Sewer and Water team includes (from left) technicians David Allen, Matt Allen and Scott Theisen, and owner Troy Oувerson.

you end up excavating under a highway (to repair a mistake), and it takes a lot of jobs to make up for that one mistake.”

Initially, Oувerson says it was difficult to find good workers. But over time, the company was able to find great employees. “I can’t say enough good things about our current crew,” he says, referring to technicians Scott Theisen, Matt Allen and Allen’s cousin, David Allen. “The other day a customer gave us a tip and said he couldn’t believe how well we all work together — everyone anticipating each other’s moves.”

**“I learned from my dad that you do things one way — the right way. When I was a kid, he’d always say, ‘Remember, we’re not digging this up again, so do it right.’ That’s stuck with me for all these years.”**

Troy Oувerson

Oувerson says thorough training and bonuses help retain good employees. Another benefit: Employees get January, February and part of March off because it’s too cold to line pipes. “Seasonal work is an incentive for them because they know they’ve got a break coming up in winter,” he says.

### KEYS TO SUCCESS

Oувerson is quick to credit his father for the company’s success. He says his father ingrained in him the value of doing things correctly — no shortcuts allowed. “I’m a perfectionist,” he says. “I learned from my dad that you do things one way — the right way. When I was a kid, he’d always say, ‘Remember, we’re not digging this up again, so do it right.’ That’s stuck with me for all these years.”

Another thing that differentiates the company: Oувerson makes a point of working on each job. That’s not because his crew needs a lot of supervision; he just believes that homeowners and contractors like to see the business owner on the job. While that eats up a lot of valuable time that could be spent doing other things, and as such makes for longer days, he believes the

personal connection with customers makes it worthwhile. “It’s a hard thing for me, trying to be a million places at one time,” he admits. “But at the same time, it’s also a good thing.”

Oувerson also believes that projecting a professional image is paramount to obtaining word-of-mouth referrals from customers. Employees wear matching T-shirts and sweatshirts and they regularly clean the company’s vehicles and equipment. “We get a lot of comments about those things,” he notes. “It’s hard to quantify, but I feel it’s important — and it’s overlooked by a lot of contractors. It just projects an image that your company cares.”

To buttress marketing and branding efforts, all of the company’s trailers and vehicles are lettered and vinyl wrapped the same way. Image, Oувerson notes, is everything. “We get comments about our vehicles all the time,” he says. “We don’t have 1,000 trucks running around, but people say they see our trucks all over town ... and think we have many different crews working around town.”

Looking back, Oувerson is grateful that the company made the shift from lateral installation to rehabilitation. “Lining is so different because every day we’re working with a new customer,” he says. “And 99.9 percent of them are happy we’re there and give us compliments at the end of the day. It’s very rewarding work.” **C**

### more info

**Delta-Waseca**  
507/835-1172  
[www.deltawaseca.com](http://www.deltawaseca.com)

**DEWALT Industrial Tool Co.**  
800/433-9258  
[www.dewalt.com](http://www.dewalt.com)

**General Pipe Cleaners**  
800/245-6200  
[www.drainbrain.com](http://www.drainbrain.com)  
(See ad page 2)

**Interstate Cargo Group, LLC**  
877/808-8477  
[www.interstatecargo.com](http://www.interstatecargo.com)

**MyTana Mfg. Company, Inc.**  
800/328-8170  
[www.mytana.com](http://www.mytana.com)  
(See ad page 93)

**Perma-Liner Industries, LLC**  
866/336-2568  
[www.perma-liner.com](http://www.perma-liner.com)  
(See ad page 7)

**RS Technik**  
919/481-1977  
[www.rstechnik.us](http://www.rstechnik.us)

**The Knapheide Mfg Co**  
217/222-7131  
[www.knapheide.com](http://www.knapheide.com)

**Towmaster**  
800/462-4517  
[www.towmaster.com](http://www.towmaster.com)



Select an application:



It's (almost) that easy.

**No matter the application, Jetstream's automated solutions make water blasting easier & safer than ever.**

Jetstream of Houston has partnered with the best in the industry to become your "Automation Depot". Only Jetstream covers all of your automated cleaning needs – innovative tools, robots and accessories, parts, and on-site application and safety training provided by an automation expert. No matter what the application, Jetstream gives you everything you need to get up and running (and stay that way). Rent, own, or rent-to-own so you can try before you buy. It's that easy.

To learn about how we can Jetstreamline™ your business, call 800-231-8192 or visit [www.waterblast.com](http://www.waterblast.com).



A proud member of the Federal Signal Family.

[www.waterblast.com](http://www.waterblast.com) 1.800.231.8192

© 2015 Federal Signal. Jetstream® Vactor® HXX® Guzzler® FS Solutions® and JetStreamline™ are registered trademarks of Federal Signal.

# Rely on Reelcraft

wwett BOOTH 1373



**Dual pedestal hose reels**  
Series 80000

## Did you know... Reelcraft can build to your specs?

Special paint colors and finishes ▶



### Reelcraft's Capabilities

- ✓ Built to your exact needs
- ✓ Very few size and weight constraints
- ✓ Special finishes/paint options
- ✓ Various drive types
- ✓ Wide range of pressures
- ✓ No minimum quantities

To learn more visit us at  
[www.reelcraft.com/custom](http://www.reelcraft.com/custom)



◀ Turn-key systems



Multiple spools ▶



**REELCRAFT**®

[www.reelcraft.com](http://www.reelcraft.com)

800-444-3134



## One Stop Shopping for Your Trenchless Needs!

24/7 Support / Free Training



### Cured in Place Pipe

- Quik Shot 3"-8" Lateral Lining
- Try Tek CWP 6"-18" Mainline Lining
- Ambient, Hot Water or Steam Cure Available
- Epoxy, Silicate, or Polyester Resins



### Try Tek Robotic Cutters

- Trydent 80 Cutter 3-6" Lines
- Legacy Cutter 6-15"



### NozzTeq Sewer Cleaning

- Lumberjack
- Predator Series



### PrimeLiner Sectional Lining Equipment & Supplies

- Materials sold in Bulk
- Pipe Repair Kits available



### Cherne PipeLine Plugs & Testing Equipment

- Test Balls/Muni-Balls
- Air Testing
- Smoke Testing

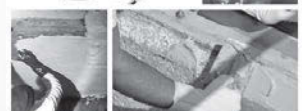

### Epoxytec Manhole/Wetwell Rehabilitation

- DIY Products
- CPP
- Uroflex



### Trelleborg/NPC Pipe Seals

- Internal Joint Seals
- Liner End Seals
- External Joint Seals
- Chimney Seals



### DeNeef Chemical Grouting

- Mainline Grouting
- Wellpoint Grouting
- Sealing underground Structures

wwett BOOTH 6400

[www.PrimeLineProducts.com](http://www.PrimeLineProducts.com)  
877-409-7888 407-772-8131

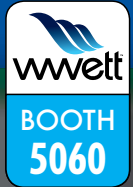

**“GREASE-X DOES  
WHAT IT USED  
TO TAKE US  
WEEKS TO DO.”**

Chad Hunter  
Bullhead City, AZ Sewer Utility

## THE RIGHT SOLUTION. RIGHT NOW.

Chad Hunter and his crews in the City of Bullhead City Arizona's Sewer Utility had their hands full. Trying to deal with six feet of grease in their lift stations, it was taking their vacuum trucks weeks to get the job done.

Then they started using Grease-X, the proven, easy-to-use way to get rid of fat, oils, and grease. (FOG) Grease-X emulsifies FOG from lift stations and you use Grease-X with your crews, your equipment, and on your own schedule.



Ready to find out more?

Email us at [rootx@rootx.com](mailto:rootx@rootx.com), or give us a call at 1-800-844-4974.

[www.rootx.com](http://www.rootx.com)

## Current Exhibitor List

3T Equipment Company Inc.  
 A. Rhodes Wilson & Associates, Inc.  
 A.R. North America, Inc.  
 ABBA Pump Parts & Service  
 Abbott Rubber Co., Inc.  
 ABCO Industries Limited  
 Acro Trailer  
 Advance Pump & Equipment, Inc.  
 Advanced Containment Systems, Inc.  
 Advanced Drainage Systems, Inc.  
 Advanced Infrastructure Technologies  
 Advanced Pressure Systems  
 Advantage Funding  
 Aero-Stream, LLC  
 AERO-TECH  
 AirSpade Division, Guardair Corporation  
 AK Industries / Hydro-Action Mfg.  
 Alderson Industries, Inc.  
 Alfa Laval Tank Equipment Inc.  
 All Star Sewer Equipment  
 Allan J. Coleman Co.  
 Allied Forward Motion, LLC  
 Allied Graphics, Inc.  
 Alpine Equipment Funding, Inc.  
 AlhumaMATS by Checkers Industrial Safety Products  
 Amazing Machinery, LLC  
 Ameri-Con  
 American Express OPEN  
 American Pipe & Plastics, Inc./Allore Plastic Pipe  
 American Sewer Parts and Cleaning Inc.  
 Amesbury Truth  
 Amthor International  
 Anua  
 AP/M Permaform  
 Aqua Blast Corporation  
 Aqua Mole Technologies Inc.  
 AQUA-Zyme Disposal Systems, Inc.  
 AquaFlow  
 AquaSales by TriStar Medical Products LLC  
 Aquatech, a product of Hi-Vac Corporation  
 Arcan Enterprises  
 Aries Industries, Inc.  
 Armal, Inc.  
 ART Company (A Restroom Trailer Company)  
 Arthur Products Co.  
 ASHLAND PolyTraps  
 Ashland Pump  
 Avanti International  
 Bad Dog Tools  
 Ball Brass & Aluminum Foundry, Inc.  
 Banjo Corp.  
 BASE Engineering Inc.  
 BDP Industries, Inc.  
 Beacon Funding  
 Benjamin Media Inc.  
 Benlee, Inc.  
 Best Enterprises, Inc.  
 Bio-Microbics, Inc.  
 Biocleaner  
 BioLyneus  
 Bionetix International  
 BKP Berolina Polyester GmbH & Co. KG  
 Black Tie Products, LLC  
 Blasters, Inc.  
 Blue Angel Pumps  
 bluefrog Plumbing + Drain @ BODUS GmbH  
 Boerger, LLC  
 Boss Industries, LLC  
 Brandenburger Liner GmbH & Co. KG  
 Brass Knuckle Protection

BRAWOLINER Karl Otto Braun GmbH & Co. KG  
 Brenlin Company, Inc.  
 BRIGHT DYES - Division of Kingscote Chemicals  
 Bright Technologies, Specialty Division of Sebright Products, Inc.  
 Brown Bear Corporation  
 Buckhorn Pumps, Inc.  
 BullFrog Industries Inc.  
 Butterworth, Inc.  
 BW Technologies / Honeywell  
 Cam Spray  
 CanAm Equipment Solutions, Inc.  
 CANVAC Trucks  
 Cape Cod Biochemical Company  
 Cappellotto S.P.A.  
 Cast Products, Inc.  
 Cat Pumps  
 Champillar, Inc.  
 CEMTEC/A.W. Cook Cement Products  
 Century Chemical Corp.  
 Century Paper & Chemicals  
 Champion Pump Company, Inc.  
 Chandler Equipment  
 Channeline International  
 Champore Corporation  
 Chemne  
 CIPP Services, LLC  
 Clayton Industries  
 Clear Computing  
 Clearstream Wastewater Systems, Inc.  
 Clearview Financial  
 Clayton Industries  
 Clear Computing  
 Clearstream Wastewater Systems, Inc.  
 Cleverleaf Tool Co.  
 Cobra Technologies  
 Comet USA, Inc.  
 Comforts of Home Services, Inc.  
 Commercial Credit Group, Inc.  
 Concrete Sealants, Inc.  
 Conegtec-Universal  
 Containment Solutions, Inc.  
 Cotta Transmissions  
 COXREELS  
 CPACEX  
 CPI Products  
 Crescent Tank Mfg.  
 Cretek Specialty Products  
 Crocodile Composite  
 CromaFlow Inc  
 Crust Busters  
 CTSPEC  
 CUJES  
 Cummins Power Generation  
 Cusco  
 D&S Professional Services  
 De Neef Construction Chemicals, Inc.  
 Deal Assoc.  
 Deep Trekker Inc.  
 Del Vel Chem Co.  
 Depth Ray  
 deSCO, LLC  
 Ditch Witch  
 Dragon Products, Ltd.  
 Drainables Direct  
 Dulmeier Sales  
 Duro-Cast Products Inc.  
 Duracable Manufacturing Company  
 Dyno Flex, Inc.  
 Dynablast  
 DynaLiner LLC  
 Dynamic Decals & Graphics, Inc.  
 Dynamic Filtration Limited  
 E-Tank, Ltd./E-Pump  
 EarthBuster, C  
 Easy Kleen Pressure Systems Ltd.  
 Easy Liner LLC  
 Ecological Laboratories

Eldon C. Shutsman, Inc.  
 Electric Eel Mfg. Co., Inc.  
 Elite Equipment Rental  
 Ejen Corporation  
 Emagineered Solutions, Inc.  
 Endura Point  
 Engineered Software, Inc.  
 Enviro-Tech of America, Inc.  
 Environment One Corporation  
 EnviroSight  
 Enz USA, Inc.  
 Epps Products  
 Equipment Sales, LLC  
 Equipump Inc.  
 Exact Pipe Tools, Inc.  
 Explorer Trailers - McKee Technologies  
 Extratech Plastics, Inc.  
 F.M. Manufacturing, Inc.  
 FacilityDude  
 Famhost  
 Federal Signal Environmental Solutions Group  
 Feigus Power Pump, Inc.  
 Ferratec, Inc.  
 Fisher Labs  
 Five Peaks  
 Five Star Products, Inc.  
 FCC Co., Ltd.  
 Fleetmatics  
 Flo Trend Systems  
 FlowMark Vacuum Trucks  
 FNA Group  
 Forbest Products Co.  
 Ford Commercial Vehicles  
 Foremost  
 Forest River, Inc.  
 Formdrain, Inc.  
 Franklin Electric  
 Franklin Fibre-Lamitex Corp.  
 Fruitland Manufacturing  
 FS Solutions  
 Fuji Clean USA  
 Galbreath  
 GapVax, Inc.  
 Gardner Denver Industrial Group  
 Gardner Denver Waterjetting Systems, Inc.  
 Gas Clip Technologies  
 GEA  
 General Pipe Cleaners  
 General Pump  
 GEOFLOW, INC.  
 GFG Instrumentation, Inc.  
 GI Industries Inc.  
 Giant Industries  
 Global Pump Company  
 Global Vacuum Systems, Inc.  
 Go Green Environmental Products  
 Go To Parts  
 Godwin, a Xylem brand  
 Goldak, Inc.  
 Gorliz Sewer & Drain, Inc.  
 Gorman-Rupp Company  
 GPS Fleet Consulting  
 Green Leaf, Inc.  
 Green Mountain International, LLC  
 Greener Planet Systems  
 GS Global Resources, Inc.  
 Guzzler Manufacturing  
 H2TR  
 Hackney  
 Hamburg Messe und Congress GmbH  
 Hammelmann Corp.  
 HammerHead Trenchless Equipment  
 Hannay Reels  
 Happy Feet  
 Harben, Inc.  
 Hathorn Corporation  
 Hazel Grain Holdings

Hedstrom Plastics  
 Helix Laboratories, Inc.  
 Hello, Inc.  
 HGACBuy Cooperative Purchasing Program  
 Hi-Vac Corporation  
 Hixon Inc. (a division of Ingersoll Rand)  
 Hino Trucks  
 HIPPO Multipower  
 Hot Jet USA  
 Howden Roots  
 Hurco Technologies, Inc.  
 Hy-Flex Corporation  
 Hydro-Flex, Inc.  
 Hydro-Tech Pumps  
 I.S.T. Services, Inc.  
 IBG HydroTech GmbH  
 ID-TEC  
 Imperial Industries, Inc.  
 Impreg International GmbH  
 IMS Robotics GmbH  
 In The Round Dewatering  
 Infiltrator Water Technologies, LLC  
 InfoSense, Inc.  
 Infrastructure Repair Systems, Inc.  
 Insight Mobile Data Inc.  
 Insight Vision Cameras  
 Integrated Chassis Solutions LLC  
 Integrated Vehicle Leasing/Financing  
 IOWPA - Indiana Onsite Wastewater Professionals Association  
 IPEX America LLC  
 ITI Trailers & Truck Bodies, Inc.  
 ITpipes  
 J & J Chemical Co.  
 J. Hvidtved Larsen US, Inc.  
 J.C. Gury Co., Inc.  
 Jack Doherty Companies  
 JAG Mobile Solutions, Inc.  
 Jet Clean Tools USA Inc.  
 Jet Inc.  
 Jets Vacuum AS/AMS Global  
 Jetsstream of Houston  
 Jetter Depot  
 Joe Johnson Equipment, Inc.  
 John Bean Jetties  
 Johnny's Choice by Chemcorp  
 KeeVac Industries, Inc.  
 KEG Technologies, Inc.  
 Keith Huber Corporation  
 Kentucky Tank, Inc.  
 Kifco, Inc.  
 Kinetics Engineering  
 Klear it Kone  
 Kroy Industries  
 Kuriyama of America, Inc.  
 LADTECH, Inc.  
 Lakeside Equipment Corporation  
 Lamar  
 Lansas Products Mfd. by Vanderlans & Sons, Inc.  
 LaPlace Equipment Co. Inc.  
 LegalShield  
 Lely Tank & Waste Solutions, LLC  
 Lenzyme Trap-Clear Inc.  
 Liberty Financial Group, Inc.  
 Liberty Pumps  
 Liquid Environmental Solutions  
 Liquid Waste Industries, Inc.  
 Liquid Waste Technology, LLC  
 LMK Technologies  
 LMT Inc.  
 LobePro Rotary Pumps  
 Lock America, Inc.  
 Lodar USA  
 Logan Clutch Corporation  
 Logiball, Inc.  
 Longhorn Tank & Trailer, Inc.

# Welcome

## to the 2016 Water & Wastewater Equipment, Treatment & Transport Show

595 companies - list current as of Jan. 4, 2016.

MacQueen Group Rentals  
 Madewell Products Corporation  
 Mailhot Industries  
 Mainline Backflow Products, Inc.  
 Marengo Fabricated Steel, Ltd.  
 Masport, Inc.  
 Material Motion, Inc.  
 MaxLiner USA  
 McLaughlin  
 Medin Inc.  
 Merrell Bros., Inc.  
 Mi-T-Machine  
 Mid-Continent Truck Sales  
 Mid-State Tank/Arthur Custom Tank  
 Miller Pipeline  
 Miller-Haufert Tool Company  
 Milwaukee Pump  
 Milwaukee Rubber Products, Inc.  
 MODRoto  
 Imperial Industries, Inc.  
 Mongoose Jetties by Sewer Equipment  
 MONOFORM by Hydro-Klean  
 Moro USA, Inc.  
 MTC  
 MTech  
 Mud Technology International, Inc.  
 Mud-Lost LLC  
 My Service Depot  
 MyTana Mfg. Company, Inc.  
 NASSCO, Inc.  
 National Joint Powers Alliance  
 National Precast Concrete Assoc.  
 National Vacuum Equipment, Inc.  
 NAWT - National Association of Wastewater Technicians  
 Netafim USA  
 Nightstick by Bayco Products, Inc.  
 NLB Corp.  
 Norweco, Inc.  
 NovaFlex Hose  
 NOWRA - National Onsite Wastewater Recycling Association  
 NozzTeq, Inc.  
 NSF International  
 NSF International  
 No Flow  
 NoConcepts  
 O'Brien Mfg., A Product of Hi-Vac Corporation  
 Oakmont Capital Services, LLC  
 Oceanquip Cables, LLC  
 Ohio Electric Control, Inc.  
 OMSI Transmissions, Inc.  
 One Biotechnology  
 Orenco Systems, Inc.  
 Otto Trading Inc.  
 PA S.p.A.  
 Parson Environmental Products, Inc.  
 Pat's Pump & Blower  
 PC Scale, Inc. (A division of AMCS Group)  
 Peinemann Equipment  
 Pelsue Company  
 Penny Pockets  
 Pentair Flow Technologies  
 People's United Equipment  
 Finance Corp.  
 Perma-Liner Industries, LLC  
 Petersen Products Co.  
 Petrolfield Industries  
 Phoenix USA Inc.  
 Picote Solutions  
 Pike Rite, Inc.  
 Pipe Lining Supply, Inc.  
 Pipe-Robo-Tec USA  
 RootX  
 Pipeline Analytics  
 Pipeline Renewal Technologies  
 PipeLogix, Inc.

Pipenology, LLC  
 PipeTech Software  
 Piranha Hose Products  
 Plug-It Products  
 Pluto Urinal - ATIAS Sanitation  
 Masport, Inc.  
 Point-of-Rental Software  
 Palston Applied Technologies  
 Poly Flow, LLC  
 Poly-Ease  
 PolyJohn Enterprises, Inc.  
 Polylok, Inc. / Zabel  
 PolyPortables, LLC  
 Porta Pro Chem Co.  
 Portable Sanitation Association International  
 Power Mole Sales LLC  
 Precision Plumbing Products, JI Industries  
 Premier  
 Premier Tech Aqua  
 Presby Environmental  
 Pressure Lift Corporation  
 Presvac Systems  
 Prime Resins  
 PRIME-GPT GmbH  
 PrimeLine Products, Inc.  
 Process Engineered Water Equipment LLC  
 Progress Tank  
 Prona-USA, Inc.  
 ProPulse, a Schieffer Company  
 ProShot Concrete  
 Protective Liner Systems  
 PSI Pressure Systems Corp  
 PumpTec Inc.  
 Qingdao Dongheng Industry Equipment Co., Ltd.  
 Quadex  
 Quality Leasing Co., Inc.  
 Quik-Lining Systems, Inc.  
 R.S. Technical Services, Inc.  
 Radlinger primus line GmbH  
 RAE Systems / Honeywell  
 Ram Commercial  
 Ramvac by Sewer Equipment  
 RapidView IBAK North America  
 Ratch Electronics, Ltd.  
 RauschUSA  
 Raven Lining Systems  
 Ravo Sweepers  
 RC Industries, Inc.  
 RCS II, Inc.  
 Real Green Systems  
 RecoverE  
 RedFactor  
 Reed Manufacturing Co.  
 Reekcraft Industries, Inc.  
 Reline America, Inc.  
 Renssi  
 Reschwitzer Saugbagger Produktions  
 Rescue Response Group  
 Resiplast US, Inc.  
 Rich Specialty Trailers  
 RIDGID  
 Ring-O-Matic, Inc.  
 Rior B.V. / Rioned  
 Ritam Technologies, LLC  
 Ritac GmbH  
 RKI Instruments, Inc.  
 Robinson Vacuum Tanks  
 ROBOSCHI USA  
 RODDIE, Inc.  
 Roeda Signs & ScreenTech Imaging  
 Roof Rat  
 RootX  
 Roth Global Plastics  
 ROTHENBERGER USA  
 Roto-Rooter Corporation

RotoSolutions, Inc.  
 RouteOptix Inc.  
 Rush Refuse Systems  
 Rush-Overland Manufacturing  
 SARTEK-multiCom  
 Safe-Fresh  
 Solarix Inc.  
 Sani Paper  
 Sansom Industries LLC  
 Satellite Industries  
 Satellite Suites  
 Sauveisen, Inc.  
 Savatech Corp.  
 Scanreco  
 SchellVac Equipment Inc.  
 Screenco Systems LLC  
 Sealing Systems, Inc.  
 See Water Inc.  
 Septic Maxx, LLC  
 Septic Services, Inc.  
 SepteTech, a subsidiary of Bio-Microbics, Inc.  
 Septronics Inc.  
 Service Roundtable  
 ServiceTitan  
 Sewer Equipment  
 Sewer Equipment Co. of America  
 Sewer Pro Shop  
 SEWERIN (Hermann Sewerin GmbH)  
 Sherwin-Williams  
 Shinnaywa  
 Shubee @  
 Sim/Tech Filter Inc.  
 SJE-Rhombus @  
 SkyBiz Local Fleets  
 Slew Master, Inc.  
 Smart-Dig Hydro Excavators  
 Smith Industries  
 Soft-Pak  
 Solar LED Innovations  
 Sonetics  
 Source One Environmental  
 Southland Tool Mfg. Inc.  
 Spartan Tool, LLC  
 Specialty B Sales  
 Stadler & Beck GmbH  
 Stamp Works Magnets  
 Standard Cement Materials, Inc.  
 Standard Equipment Company  
 StoneAge, Inc.  
 Strike Products  
 Subsite Electronics  
 SubSurface Instruments, Inc.  
 Sunbelt Rentals  
 Super Products LLC  
 Superior Signal Company LLC  
 Supravac 2000  
 Surco @ Portable Sanitation Products  
 Suppressor 4S Inc.  
 Suther America  
 SVE Portable Roadway Systems, Inc.  
 T&T Tools, Inc.  
 T.S.F. Company, Inc.  
 T4 Spatial  
 TankTec  
 TCF Electronics  
 Tecnova Finance  
 Terre Hill Composites, Inc.  
 Terydon Inc.  
 The Plug Hug  
 The Strong Company  
 Thieman Tailgates, Inc.  
 Thompson Pump and Manufacturing Co., Inc.  
 Titan Logix Corp.  
 TomTom Telematics  
 TOPP Industries, Inc.

Trade-Serve  
 Trailer Transit, Inc.  
 Trans Lease, Inc.  
 Transway Systems Inc.  
 Transwest - Oilfield Truck Equipment  
 TRY TEK Machine Works, Inc.  
 Tsurumi Pump  
 TT Technologies, Inc.  
 Tuf-Tite Inc.  
 TURBO FOG Division of Kingscote Chemicals  
 Turtle Plastics  
 UDOR U.S.A.  
 UEMSI - HTV  
 UHRIG Kanaltechnik GmbH  
 Ultra Shop  
 UltraLuv by Wells Cargo  
 UltraVac, a division of Hi-Vac Corporation  
 Uncle Freddie's LLC  
 Under Pressure Systems, Inc.  
 URACA GmbH & Co. KG  
 US Fleet Tracking  
 US Jetting, LLC  
 US Sewer Equipment Corporation  
 Vac-Con, Inc.  
 Vac-Iron Equipment  
 Vac2Go, LLC  
 Vacall - Gradall Industries  
 Vacuum Manufacturing  
 Vacuum Sales, Inc.  
 Vacuum Truck & Trailer  
 Vacuum Truck Rentals  
 Vanair Manufacturing  
 Vanguard Pathogen Defense Systems  
 Vantage Trailers, Inc.  
 Vaporooter  
 VARCo  
 VIBAC Inspection Systems (VIS)  
 Vibe-Tracking Solutions  
 Vixx-Metrotech Corp.  
 Vogelsang  
 W.W. Williams  
 Wachs Utility Products  
 Wager Company Inc.  
 Walex Products Company, Inc.  
 Walla Walla Environmental  
 Wallenstein Vacuum Pumps - Elmira Machine Industries  
 Warren Environmental  
 Wastequip  
 WasteWater Education 501 (c)3  
 Water Environment Federation  
 WC Leasing  
 Wehral Pumps  
 Wee Engineer, Inc.  
 Wells Fargo Equipment Finance  
 Hi-Vac Corporation  
 Western Equipment & Sales  
 Western Mule Cranes (D&S Sales)  
 Westmool Ltd.  
 Wiedemann Enviro Tec  
 Wieser Concrete  
 Wohler USA, Inc.  
 WRM  
 X-Vac, A Product of Hi-Vac Corporation  
 Zhejiang Danau Industries Co., Ltd.  
 Zia Systems LLC  
 Zoeller Company  
 Zoom Drain & Sewer Service

# Education Day Sessions

Wednesday, February 17, 2016

## NAWT

National Association of Wastewater Technicians

Rooms 234-236

- 8 a.m. Basics of Septic System Control Panels
- 9:30 a.m. Using Septic Control Panels to Troubleshoot Systems
- 11 a.m. Inspecting Concrete Sewage Tanks
- 1:30 p.m. An Exercise in Septic System Troubleshooting
- 3 p.m. The Basics of Inspecting Drip Systems
- 4:30 p.m. NAWT Ask the Experts Panel Discussion

## SSPMA

Sump and Sewage Pump Manufacturers Association

Rooms 133-135

- 8 a.m. Understanding Pumps and Common Pumping Issues
- 9:30 a.m. Evaluation and Installation of Backup Pump Systems
- 11 a.m. Best Installation Practices for Trouble-Free Pump Controls
- 1:30 p.m. Troubleshooting Pumps, Panels and Switches with Digital Multimeters
- 3 p.m. Sizing Guidelines for Sump, Sewage and Grinder Pumps
- 4:30 p.m. SSPMA Ask the Experts Panel Discussion

## Business Strategies

Rooms 140-142

- 8 a.m. How Much Should I Charge?
- 9:30 a.m. Business Game Changers: Top 5 Secret Strategies for Massive Growth in Your Service Business
- 11 a.m. The Un-Business Plan – Making Your Business Less Complicated But More Profitable
- 1:30 p.m. How to Use Superior Customer Service to Increase Sales
- 3 p.m. Reward the Right Stuff: Finding, Training and Keeping Great Team Members
- 4:30 p.m. Is Your Business Prepared for a Crisis?

## Industry Safety

Rooms 237-239

- 8 a.m. Pre-Engineered Shoring Systems for Cross-Trench Utility Challenges
- 9:30 a.m. Excavation Safety
- 11 a.m. OSHA Confined Space, Air Monitoring and Fall Protection Explained

## SSCSC

Southern Section Collection Systems Committee

Rooms 231-233

- 8 a.m. Positioning Yourself for Promotion and Succession Planning
- 9:30 a.m. Step Up Your Game! Taking Current CCTV Inspection Technology to the Next Level
- 11 a.m. Trailer Jetting – Getting the Most Out of Your Equipment
- 1:30 p.m. Vacuuming: the Other Half of the Combination Unit
- 3 p.m. Sewer System Maintenance – Challenges and Solutions
- 4:30 p.m. SSCSC Ask the Experts Panel Discussion

## NOWRA

National Onsite Wastewater Recycling Association

Rooms 240-242

- 8 a.m. Introduction to Soils
- 9:30 a.m. Onsite Septic System Loading Rates and Site Layout
- 11 a.m. Making Infiltration Decisions – Understanding Soil Surface Design
- 1:30 p.m. Soil Dispersal Comparison
- 3 p.m. Introduction to the Elements of Onsite System Design and Regulations
- 4:30 p.m. Onsite Septic System Hydraulics and Pump Design

## Portable Sanitation

Rooms 136-138

- 1:30 p.m. Marketing Basics: How to Effectively and Efficiently Grow Your Portable Sanitation Sales
- 3 p.m. Trust – How to Build it and Use it to Grow Your Portable Sanitation Business
- 4:30 p.m. Portable Sanitation Forum: Current and Future Critical Issues Affecting the Industry Discussion

## NASSCO

National Association of Sewer Service Companies

Rooms 130-132

- 8 a.m. Cleaning Nozzle Technology
- 9:30 a.m. Large vs. Small-Diameter Pipe Cleaning
- 11 a.m. The Lower Lateral – The New Frontier in Sewer Rehab
- 1:30 p.m. Chemical Grouting Technologies
- 3 p.m. The Growth of the UV Cured CIPP Process
- 4:30 p.m. NASSCO Ask the Experts Panel Discussion

## Treatment Plant Operator

Rooms 243-245

- 8 a.m. Effective Strategies for Collections System Management
- 9:30 a.m. Sustainable Innovation in Biosolids Management
- 11 a.m. Pretreatment and Wastewater Lagoon Management
- 1:30 p.m. Septage Collection and Treatment
- 3 p.m. Large Scale FOG/Septage Receiving Station – Lantern Environmental Project Case History
- 4:30 p.m. Progress in Electrochemical Water Treatment in Last Century

## WJTA-IMCA

Water Jet Technology Assoc. - Industrial Municipal Cleaning Assoc.

Rooms 237-239

- 1:30 p.m. Proper Industrial Truck Maintenance Can More Than Pay for Itself in Productivity and Safety
- 3 p.m. Air Conveyance Through an Industrial Vacuum Truck
- 4:30 p.m. Vacuum Excavation Applications and Opportunities

## Women in Business

Rooms 136-138

- 8 a.m. Marketing to Women
- 9:30 a.m. Women of Wastewater: Building a Community of Allies
- 11 a.m. Women in Wastewater Roundtable

## Vacuum Truck Equipment and Operation Training

presented by NAWT National Association of Wastewater Technicians

Rooms 109-110 8 a.m. - 5 p.m.

This day-long session will discuss in detail the equipment on vacuum trucks and how to operate them. Pumping terms will be covered, as will safety principles, materials often encountered on the job and government regulations.



**RUGGED & RELIABLE**

**PROFESSIONAL GRADE EQUIPMENT**

**Made in USA**

**Ideal For Grease Trap Service**



**Simply the BEST!!**



**ELECTRIC POWERED**

**ProVac**

**Industrial Pumpout System**

**Designed, Machined & Assembled in the USA**



**ProCheck - Transport Hold Down**



**GASOLINE POWERED**

**Check Us Out - Booth No. 5124 at the WWETT Show**

[www.westmoorltd.com](http://www.westmoorltd.com)

Westmoor Ltd., 906 West Hamilton Ave, Sherrill, NY 13461

**TEL (800) 367-0972**

# Need Jetting Hoses?

Jetting/Lateral Line Hoses

Large Diameter Hoses Up To 1-1/2"

Piranha® Standard High Pressure Sewer Cleaning Hoses

Piranha Armor Belt® Sewer Cleaning Hoses

Piranha® Slither™ High Pressure Sewer Cleaning Hoses

Twin/Multi Lines

**wwett**  
BOOTH  
3013

For samples, literature and more information contact us at



**Piranha Hose Products, Inc.,**  
Cadillac, MI

**1-800-250-5132**

[www.piranhahose.com](http://www.piranhahose.com)

[WWW.VACTRUCKRENTAL.COM](http://WWW.VACTRUCKRENTAL.COM)

# NEED IT? RENT IT!

**AIR MACHINES • LIQUID VACS • SS LIQUID VACS • LIQUID RINGS  
ROLL-OFFS • CYCLONES • COMBOS • HI-RAILS • EXCAVATORS • TANKERS**



**YOU MIGHT AS WELL  
RENT FROM THE BEST!**

**1-888-955-2087**

Mississippi • Louisiana • Texas • South Carolina  
Ohio • New Jersey • Massachusetts • Indiana  
[www.vactruckrental.com](http://www.vactruckrental.com)



**NEW!**

# MORE WITH LETS

**LETS6.0**



Now you can quickly inspect laterals with the new LETS 6.0 operating in 6-inch to 30-inch diameter mainlines. This completely upgraded system can increase your productivity and uptime:

- Fast camera launching with improved contoured chute
- Efficient 135-degree with-the-flow launch angle
- More power to traverse pipe against flow
- Pan & Tilt camera with self-cleaning lens
- Rear view camera

**Keep your crews moving. Get more with LETS.**



**ARIES**  
INDUSTRIES, INC.

See what you're missing.

[www.ariesindustries.com](http://www.ariesindustries.com)  
(800) 234-7205





WATER & WASTEWATER EQUIPMENT,  
TREATMENT & TRANSPORT SHOW

INDIANA CONVENTION CENTER

FEB. 17, 2016 - Education Day

FEB. 18-20, 2016 - Exhibit Hall Open

# Time to Unwind

Country artist Jerrod Niemann ready to give WWETT Show attendees a night of music and fun

By Cory Dellenbach

It doesn't matter if you're a country music fan. Jerrod Niemann is going to draw you in when he hits the Industry Appreciation Party stage Feb. 19.

"You have to be aware of what you're around," says Niemann, country music star and entertainer for the party. "If you're doing your own show or people are there just because of you it's one thing. If you are part of a party that has already existed for many years, we try to be a chameleon of sorts. We'll do our own songs, but we'll also throw in a couple different ones, too, from rock and blues and everything."

No matter what he sings, Niemann promises a fun time for everyone at the Indiana Convention Center's Sagamore Ballroom.

"There's just something to be said about being around people who are pretty much just like you — hardworking, small-town Americans," Niemann says. "For me, I love being out there and hanging out with everybody."

## IN HIS BLOOD

Country music has always been in Niemann's blood, and he thanks his mother for that: "I was doomed from the beginning hearing country music from the womb. My parents ran a bar when my mom was pregnant with me and I think hearing all those country songs on the jukebox got me going."

From an early age, Niemann was influenced by country acts such as Lefty Frizzell, Keith Whitley and George Strait. After graduating from high school, he attended South Plains College in Levelland, Texas, pursuing an Associate of Arts degree. He began his professional career by singing and playing acoustic guitar in Texas clubs and bars.

"I did that for about a year, just my guitar and me," he says. "Then I moved to Nashville and started working out there. Music is one of those

## THE BASICS

### INDUSTRY APPRECIATION PARTY

**WHEN:** Friday, Feb. 19  
**WHERE:** Sagamore Ballroom,  
Indiana Convention Center, Indianapolis  
**TIME:** 5 p.m. doors open;  
7 p.m. Jerrod Niemann

things where it's such an amazing thing to be a part of that once you've been bitten by the bug, there is no way out of it. It's just who you are."

In 2010, Niemann signed with record label Arista Nashville and released his debut single, "Lover, Lover." It became his first Top 40 single on the country music charts, and in August 2010 it hit No. 1.

Since then, Niemann has released four albums — *Judge Jerrod & the Hung Jury*; *Free the Music*; *Yellow Brick Road*; and *High Noon*. In 2013, his single "Drink to That All Night" hit No. 4 on the U.S. country charts and No. 1 on U.S. country airplay charts.

"I got my foot in the door writing songs in Nashville, and it's always fun being able to write your own material," Niemann says. "Every once in a while you find a song you wish you had written."



**NEW! Available in  
FR OUTER MATERIAL**

# **WATERJET PROTECTION**

**PROTECTIVE CLOTHING - WITH THE STRONGEST FIBER IN THE WORLD!**



**PROTECTION LEVEL 10/28**  
— SINGLE 1000 bar/15000 psi  
— ROTOR 2000 bar/30000 psi  
CE 89/66/EEC

**PROTECTION LEVEL 20/30**  
— SINGLE 2000 bar/30000 psi  
— ROTOR 3000 bar/43500 psi  
CE 89/66/EEC

- + **PROTECTION UP TO 43500 PSI**
- + **CE CERTIFIED  
VERIFIED PROTECTION**
- + **FAST AND EASY GEAR UP  
TO MAXIMIZE PRODUCTIVITY!**
- + **RESISTS WATER AND DIRT  
KEEPS OPERATORS DRY!**
- + **FR OUTER MATERIAL  
AVAILABLE TO ORDER**



Find US distributors, News, Movies and E-catalogues, at:

**WWW.TST-SWEDEN.COM**

## **NEW MUSIC**

One of those songs is “Blue Bandana,” his newest single released in July. The song will be a part of his new album set for release later this year.

“When I heard the song it just took me to so many cool places and really took me to a lot of cool faces, too,” Niemann says. The song tells the story of a fan attending concerts wearing the same blue bandana and the singer noticing it each time. “Just traveling this country you see a lot of people who are kind enough to pack up in their cars and do a road trip spending their hard-earned money to see us. I’ve never really done a song that is a thank-you to those folks out there, but this song does that.”

The new album will combine music he’s done before — a country/rock mix — and the more traditional country sound. “It’s a wide array of music,” Niemann says.

He’ll perform some of the new songs from that album at the WWETT Show and hopes everyone can relax and get their minds off work and anything else going on in their lives.

“The real world can be quite a hard place at times for people, and if we can be the guys to get that off their minds for at least 90 minutes, then we’ve done our jobs,” Niemann says. “I just always try to keep a thread of laughter and craziness at our shows if we can.” **C**

## **THREE NIGHTS OF WWETT SHOW FUN**

By Luke Laggis

You come to Indy for the tools and equipment, the people and excitement. It’s the one time of the year when the whole industry comes together. So let’s have a party.

COLE Publishing celebrates the occasion every year with the Industry Appreciation Party. It’s a chance for everyone to relax and enjoy themselves. This year, the WWETT Show Kickoff Party will give you two nights to enjoy leading up to the Industry Appreciation Party.

It all starts Wednesday night. After the final bell rings on Education Day, you can head over to Lucas Oil Stadium, connected to the Indiana Convention Center, for a cold beverage and complimentary hors d’oeuvres while you network with manufacturers and peers. The event will be held Feb. 17-18 from 5 to 8 p.m.

Exhibitors have been invited to co-host the event along with COLE Publishing, and the COLE Pub truck will return to serve as the central bar. Attendees and exhibitors can kick back, relax, share stories or solve problems with industry peers.

“We are very excited to see how creative the co-hosts decide to be,” says Brad Bisnette, the show’s coordinator. “All will be providing a good time for sure.”

On Friday night, the focus will shift from Lucas Oil to the Sagamore Ballroom in the Indiana Convention Center for the Industry Appreciation Party. Country music star Jerrod Niemann will perform an up-close and personal concert for WWETT attendees. Beers are a quarter and the show is free, so you really can’t go wrong.

Visit [www.wwettshow.com](http://www.wwettshow.com) for complete details on the show. The Kickoff and Industry Appreciation parties are free for all registered attendees.



# High Performance SEWER CLEANING EQUIPMENT

USB - SEC

Your **JETTER** comes to **LIFE** with our **UNRIVALED EQUIPMENT!**

USB-SEWER EQUIPMENT CORPORATION proudly distributes INNOVATIVE, HIGH QUALITY sewer cleaning equipment, precision engineered and manufactured by our ISO EN 9001:2000 certified affiliated company USB Duesen in Germany to the highest technical standards. These products are leaders in the industry and include **NOZZLES**, **TURBO CHAIN CUTTERS**, **MILLING CUTTERS**, **SPECIALTY TOOLS** and **ACCESSORIES** for the municipal and industrial markets.

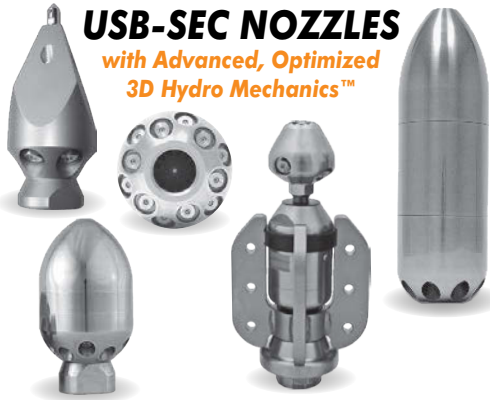

**USB-SEC NOZZLES**  
with Advanced, Optimized  
3D Hydro Mechanics™

**TURBO CHAIN CUTTERS**  
Adjusts From 8"-16" And With  
Expansion Kit Up To 24"

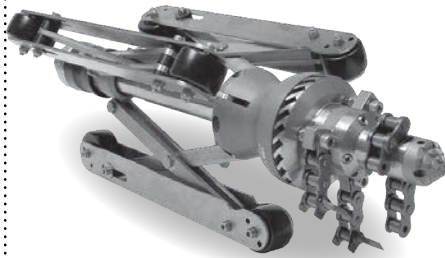

**MILLING CUTTERS**

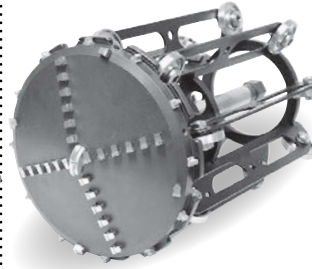

**SPECIALTY TOOLS**



FOR A DISTRIBUTOR NEAR YOU, PLEASE CONTACT:



## USB-Sewer Equipment Corporation

1700 Enterprise Way • Suite 116 • Marietta, GA 30067 • TOLL FREE 1.866.408.2814

USB - SEC PHONE 770.984.8880 • FAX 770.984.2802 • EMAIL [info@usbsec.com](mailto:info@usbsec.com) • WEB [www.usbsec.com](http://www.usbsec.com)



BOOTH  
5043



**T&T TOOLS**

**T&T Tools, Inc.**

Fax: 800.521.3260

Email: [sales@mightyprobe.com](mailto:sales@mightyprobe.com)

**800.521.6893**  
**[www.MightyProbe.com](http://www.MightyProbe.com)**

Call for a FREE Catalog



Call for a FREE Catalog

### HOOKS...

- > Several different styles of heat-treated hooks are available
- > Top Poppers are great to open manhole covers
- > The Handy Hooks allow two handed use



### PROBES...

- > Insulated, standard, and specialty soil probes
- > Metal shaft sizes: 3/8" round, 3/8" hex, or 7/16" hex
- > Replaceable tips are threaded on and hardened
- > A "slide" allows the handle to pound the shaft into the ground

# UNDERGROUND UTILITIES - BEWARE WHAT LIES BENEATH

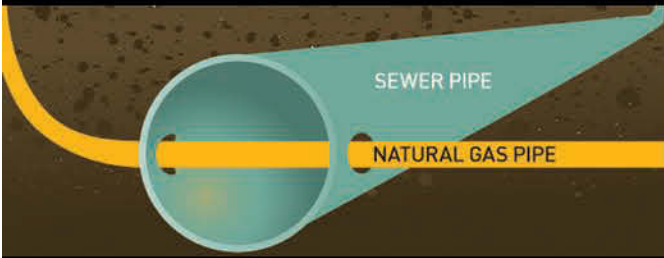

**A gas line that penetrates a sewer/storm line can rupture with explosive results!**

## LAMP II Lateral & Mainline Probe with Mini Pan & Tilt Camera

**PAN & TILT INSPECTION OF ALL LATERAL SERVICES, WITH OR AGAINST THE FLOW! SIMULTANEOUS PAN, TILT & ZOOM INSPECTION OF MAINLINES!**

- The system provides for easy entry into lateral services with "WYE" connections while inspecting with or against the flow! Navigate through multiple "wyes", bends, and sweeps!
- Self-leveling camera image is always upright; camera has 360 degree continuous pan and tilt capabilities.
- Built-in wiper system keeps the camera lens clean; no need to remove the camera from the pipe to clean the lens!
- Built-in multi-frequency sonde transmitter.



**BLUE = NOT INSPECTED**  
**GREEN = SEWER LATERAL CLEAR OF UTILITIES**  
**RED = GAS MAIN IN SEWER LATERAL**  
**YELLOW = GAS LINE**

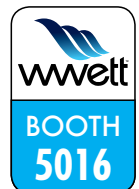

- Complete 'Pre' and 'Post' gas line installation inspections using Granite software with the optional Lateral Inspection Module to generate full reports for easy analysis and delivery to the client; sort all inspections with critical issues and email them to the installer.



Available with a rear-viewing camera!

Contact CUES for a discussion & demonstration!  
 800.327.7791  
 www.cuesinc.com  
 salesinfo@cuesinc.com



**TODAY'S TECHNOLOGIES FOR LOCATING BURIED UTILITIES**



# THE TOOLS TO SUCCEED

EQUIPMENT AND TRAINING KEY RAPID GROWTH  
FOR INSPECTION AND REHABILITATION CONTRACTOR

BY KEN WYSOCKY | PHOTOGRAPHY BY KEVIN MANNING

Pipevision Vactor truck operator Tommy Kennedy marks the position of a camera in an underground line while head technician Robert Wilson stands by at the manhole.

EVER SINCE PIPEVISION OPENED ITS DOORS IN 2010, THE PIPELINE INSPECTION AND REHAB COMPANY HAS OPERATED ON A SINGULAR PRINCIPLE: **CONTINUALLY INVEST IN RELIABLE, TOP-NOTCH EQUIPMENT THAT SIGNIFICANTLY IMPROVES PRODUCTIVITY AND KEEPS CUSTOMERS SATISFIED.**

Based in Ashland, Virginia, the company — a wholly owned subsidiary of Accumark Inc., a subsurface utility locating and services company — has invested more than \$3 million in equipment since its inception. Coupled with an emphasis on highly trained and professionally certified employees, this two-pronged strategy has enabled the company to grow exponentially from just one camera truck and one vacuum truck to a large fleet of equipment in just five years, says Craig Martin, president and co-owner of the company. The other co-owner, Dan Clatterbuck, serves as vice president.

“Our business on the camera side (Pipevision) has grown more than 400 percent in the last five years,” Martin says. The key to such rapid growth? “Building

relationships,” he says. “People trust that we’ll do a good job for them — that we’ll be on time and charge a fair market price. And provide high-quality work.”

“We’re constantly reinvesting in equipment,” Clatterbuck adds. “We’re always trying to find the best equipment that can help us limit confined-space entry and optimize time in the field — get as much done as possible in the shortest amount of time. Ultimately, that allows us to provide clients with very competitive prices. In addition, newer equipment breaks down less frequently, which increases customer satisfaction.”

Four 2100 PD combination sewer vacuum trucks built by Vactor Manufacturing (a subsidiary of Federal Signal Corp.) form the backbone of the company’s equipment fleet. The units are built on tandem-axle



The Pipevision team includes (from left) field supervisor Victor Reyes, head technician Robert Wilson, owner and Vice President Dan Clatterbuck, owner and President Craig Martin, Vactor truck operator Tommy Kennedy and camera operator Bryan Reese.



Tommy Kennedy uses a Radiodetection RD4000 locator to mark sewer lines for a natural gas company.

truck chassis made by International, Kenworth and Freightliner. Each truck features a 12-cubic-yard debris tank, a 1,500-gallon water tank, a water pump that generates pressure of 2,000 psi and flow of 80 gpm, and a 5,000 cfm

**“We’re always trying to find the best equipment that can help us limit confined-space entry and optimize time in the field — get as much done as possible in the shortest amount of time.”**

Dan Clatterbuck

blower built by Roots Systems. In addition, two of the trucks are equipped with hydroexcavation packages, which help crews install clean-outs more efficiently, Martin says.

The company’s motto is, “Discover the unexpected.” To accomplish that, Pipevision also invests heavily in pipeline inspection camera systems from Envirosight. That includes four CCTV camera trucks outfitted by Envirosight; three Rovver X SAT lateral launch cameras; one Rovver 125 crawler camera;

profile

## PIPEVISION LLC,

ASHLAND, VIRGINIA

**OWNERS:** Craig Martin and Dan Clatterbuck

**FOUNDED:** 2010

**EMPLOYEES:** 16

**SERVICES:** Pipeline inspections and cleaning

**SERVICE AREA:** Virginia, Maryland, North Carolina and Washington, D.C.

**WEBSITE:** [www.pipevisionllc.com](http://www.pipevisionllc.com)



three VeriSight Pro push cameras; several QuickView pole cameras, which minimize the need for confined-space entry; and four JetScan high-definition cameras that fit on the end of the vacuum trucks’ jetting nozzles, providing dual inspection/cleaning capability.

Work in the municipal sector generates about 40 percent of the company’s annual gross revenue. That includes a large on-call contract with the City of Richmond. The balance stems from work performed for land development companies, industrial facilities and general contractors that install water and sewer lines.

## A QUICK START

Pipevision was born after Accumark officials decided to diversify the company's subsurface inspection services. In 2010, Martin and Clatterbuck decided to make Pipevision a stand-alone company.

"Getting started wasn't all that difficult," Martin says, noting that the company relied on the same formula that made Accumark successful: fair pricing and great customer service. "We came out of the gates running. The biggest challenge was just getting our name out there, but it helped that we were able to leverage our existing customer base. That's what enabled us to get things going ... gave us the confidence to buy our first vacuum truck and start building from there."

Two other factors converged to jump-start Pipevision's growth: aging water and sewer infrastructure in the areas the company serves (Virginia, Maryland, North Carolina and Washington, D.C.), coupled with an improving economy that's spurring land development — and the underground infrastructure that accompanies that development, Clatterbuck says.

Investments in new, technologically advanced equipment also help the company attract new clients. "The appearance of your equipment when you come on a job site speaks to quality of work and the quality of the employees you have working for you," Clatterbuck says. "I remember a trial run we did with a lining company for which we now do a lot of work. We went out on the job with our best equipment, and now we have a contract to work for them."



**ABOVE:** Tommy Kennedy (left) and head technician Robert Wilson prepare to launch an EnviroSight Rover X sewer camera on a sewer cleaning and locating project for Columbia Gas.

**BELOW:** The camera is pulled back up the manhole alongside the Vactor's vacuum tube after an inspection.



"They were ecstatic when they saw our equipment because the company they used before had equipment with hydraulic oil leaks," he adds. "Sometimes that equipment would run and sometimes it wouldn't."

## ADVANCED TECHNOLOGY

Moreover, customers are impressed when a contractor can provide convenient services such as live video feeds of pipeline inspections, an advanced feature on some EnviroSight camera systems. Operators can also email videos to clients right after inspections. "That way, even if the client is out of state, they can quickly start an action plan without any delays," Clatterbuck explains.

Furthermore, project delays are a profitability and goodwill killer for any contractor. "If you miss a deadline in a time-critical project, it doesn't

# The Formula for Success is Simple.

- Hire good people.
- Take care of your customers.
- Buy the best equipment.

Industry leaders prefer Cat Pumps, the most reliable, longest-lasting pump.



**Model 3550**  
Rated to 10 gpm and 6,000 psi

When it has to run, make it Cat Pumps.

[www.catpumps.com](http://www.catpumps.com)  
(763) 780-5440 | [info@catpumps.com](mailto:info@catpumps.com)

**CAT PUMPS**  
The Pumps with Nine Lives

© 2015 Cat Pumps All Rights Reserved. 15429 12/15

look good for anybody,” he says. “I’d say that probably 90 percent of our work requires us to get in and get out as quickly as possible. We can’t afford breakdowns.”

To keep projects running on schedule, the company also focuses on making sure all employees can operate the same equipment. For example, all field employees can operate the various inspection camera systems, so projects aren’t delayed if one employee calls in sick or has to leave work early, Clatterbuck says. “We can keep on working and meet the finish dates for our clients,” he notes.

A stable of great equipment offers another benefit, too: It helps the company attract and retain good workers. “We think it’s very important to provide our people with the best equipment we can find,” Martin explains. “Typically, if you give people good equipment to work with that doesn’t break down all the time, they stay motivated to provide quality work.”

One particularly difficult project underscores the benefits of investing in quality equipment, Clatterbuck says. The project centered on 2,500 feet of 54-inch-diameter, state-owned pipe that was continually backing up during heavy rains, which produced ponding on a nearby roadway. The pipeline was located in a swampy area that made access extremely difficult.

But Pipevision had the right equipment to get the job done, including a Gator all-terrain vehicle, made by Deere & Co., that was able to negotiate the swampy terrain and

CONTINUED >>



Robert Wilson (left) and Bryan Reese maneuver an inspection camera into a raised sewer line along Union Street in Richmond, Virginia.

## INVESTING IN EMPLOYEES MINIMIZES JOB TURNOVER

Like many companies that rely on skilled labor, finding experienced, qualified employees is one of the most difficult challenges faced by Pipevision, a pipeline inspection and rehabilitation business based in Ashland, Virginia.

“We get a lot of applicants when we have job openings, but the majority of them are not qualified,” says Dan Clatterbuck, vice president and co-owner of the company. “And the average person with little experience will struggle to do what we do.”

To attract and retain workers, the company emphasizes comprehensive employee training that includes professional certifications in a variety of operational areas. This focus on job training also pays off by making operations more efficient while at the same time fostering employee loyalty, Clatterbuck says.

All employees receive training in first aid (including CPR certification), defensive driving and confined-space entry. In addition, they complete the following certifications: Pipeline Assessment and Certification Program (PACP), Manhole Assessment and Certification Program (MACP) and Lateral Assessment and Certification Program (LACP), all offered by the National Association of Sewer Service Companies. Employees are also required to earn the Hazardous Waste Operations and Emergency Response Standard (HAZWOPER) certification, says Craig Martin, co-owner and president.

“It costs about \$850 per person to obtain three of those certifications (PACP, MACP and LACP),” Clatterbuck says. “But it’s a great investment for our clients — and our employees. It also is a selling point for clients. It’s one of the reasons we win so many contracts. ... We’re qualified to do work that other companies aren’t.”

The comprehensive training also contributes greatly to job safety, which is critical for both business and ethical reasons. First of all, contractors with poor safety records don’t last long in any industry. “And our clients’ safety record is impacted by our safety record,” Clatterbuck points out. But even more importantly, the company’s No. 1 priority is sending its workers home safely to their families every day, Clatterbuck notes.

In addition, the company also pays 80 percent of employees’ health care insurance premiums. The end result of all these efforts? Martin says that despite the company’s rapid growth, only two people have left the company since its inception.

“Our workforce understands what they have,” he says. “If you invest in your employees, they respond accordingly.”



# ALLAN J. COLEMAN

## SINCE 1905

Call us today!  
773-728-2400

5725 North Ravenswood Avenue • Chicago, IL 60660 • info@allanjcoleman.com • www.allanjcoleman.com



**CALL FOR  
GENERAL  
SPECIALS**



JM-1000

**Special pricing  
on all  
General jetters,  
cameras and  
machines**



JM-2900

### Warthog® Nozzles



**Repair Center for: RIDGID SeeSnake, Gen-Eye, Radiodetection, Electric Eel, Vision Technology & Insight Vision Cameras Fast Turnaround Time**

## UPGRADE your camera system to the GVISION. A Better System



Visit [www.eplsolutions.net](http://www.eplsolutions.net) for more details.

### GVISION

Gvision V3 is a universal monitor capable of recording from a variety of camera reels. View the screen in the blaring sunlight or in the shade with no visible difference. This ruggedized monitor records onto flash drives, hard drives, and an iPhone®, iPad®, or iPod Touch®. Connect to the A/V in/out connector to use DVD-RECs and other compatible recorders.



A specialized sonde for locating cast iron and non-metallic pipe 20+ feet deep.



Ask what the **GPLAYER** can do for you?



JetSonde Carriers - P-Trap Cable Sonde Carriers

**Turn ANY push camera into a Jetter Camera with the JetCam Adapter.**



JetCam Adapter

JetSonde Nozzle

Jetter Hose

**OLDEST NAME IN THE BUSINESS**  
**— Over 100 YEARS OLD —** PHCC MEMBER

# Flexible and Affordable Financing Options

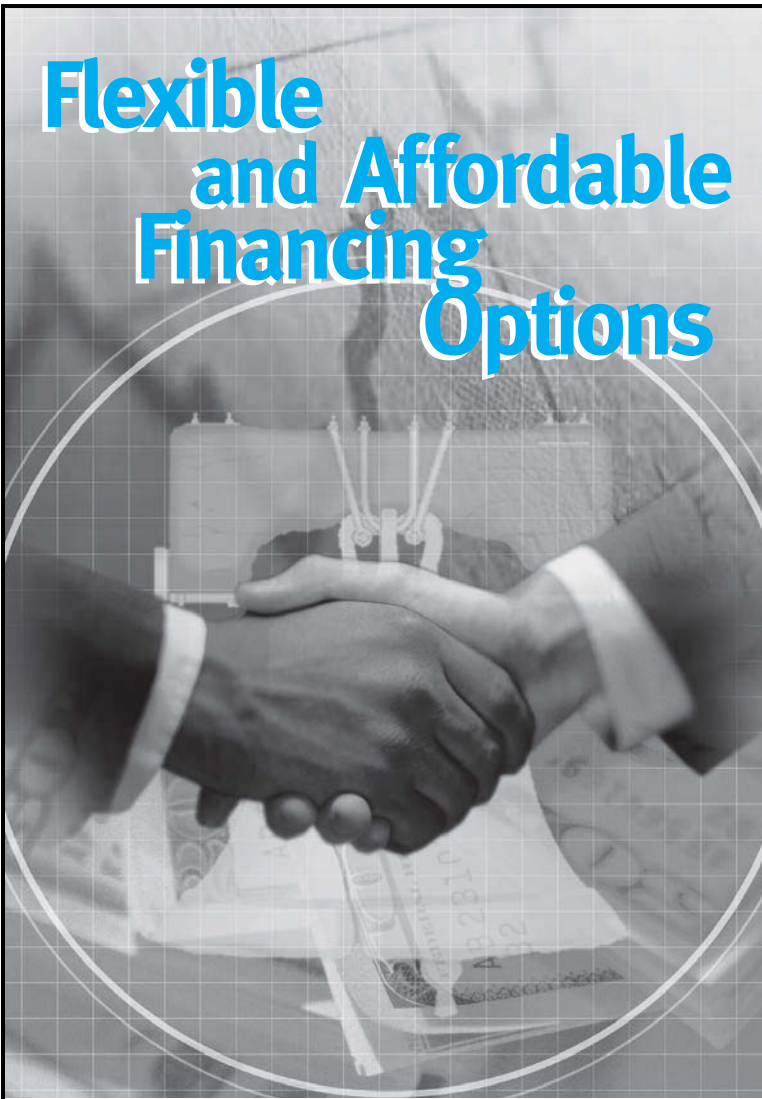

## Financing for New and Used Equipment:

Trucks                      Tanks  
Trailers                     Toilets  
Cameras                    Jetters

also Computer Hardware & Software



7 Church Road Hatfield, PA 19440  
Phone: 800.422.1844 Fax: 888.883.9380  
Visit our website: www.libertyfg.com

**COMMERCIAL EQUIPMENT FINANCING**  
**CALL 800-422-1844 EXT. 112**

**“If you miss a deadline in a time-critical project, it doesn’t look good for anybody. I’d say that probably 90 percent of our work requires us to get in and get out as quickly as possible. We can’t afford breakdowns.”**

Dan Clatterbuck

carry a Rovver X inspection camera out to hard-to-access manholes.

“They thought the problem was a maintenance issue involving tree root intrusions, but an inspection revealed that the pipe itself needed to be relined,” Clatterbuck recalls. “Some of the pipe joints had slipped and dropped down, so there was a lot of groundwater infiltrating the pipe.”

### GOOD OUTLOOK

As for the future, Martin and Clatterbuck envision further growth but in a measured and controlled fashion, nothing like the exponential business increase the company has experienced during the last five years or so. “We would like to broaden our client list a little bit and aside from that, just keep going, going and going,” Clatterbuck says. **c**

### more info

**Envirosight**  
866/936-8476  
www.envirosight.com  
(See ad page 5)

**Radiodetection Corporation**  
877/247-3797  
www.spx.com/en/radiodetection

**Roots Systems Ltd**  
www.roots-blowers.com

**Vactor Manufacturing**  
800/627-3171  
www.vactor.com

## KEN-WAY Beats the Others DAY-IN • DAY-OUT

And they have for over 50 years

### KEN-WAY CABLE CLEANERS

for cleaning sewer, drain or process lines  
from one to ten inches, up to 75 feet  
with the Junior and up to  
a full length of 300 feet  
with the Model 400



### KEN-WAY Exclusive Built Cables

- Heat Treated
- Inner-Core or Non-Core
- Fit Most Other Brands
- Interchangeable with Most Brands
- Coupling or Blade Holding Types



Leasing plans available. Call for details.

**1-800-533-0551**

930 ROBERTS ROAD, SPARTA, WI 54656  
www.ken-way.com • E-mail: info@ken-way.com

# All-In-One STEAM TRUCKS

Custom Built Steam and Hot Water Trucks For Sale, Lease or Rent.

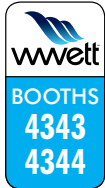

- 150 HP Steam Generator
- 750 CFM Air Compressor
- 25 KVA - 3 Phase Generator
- Chemical Injection System
- 1100 Gallon Fresh Water Tank



- Enclosed Control Room
- 24' Enclosed Body
- 3 Side Roll-up Doors
- 160 Cubic Feet Of Storage
- Underbody Hose Storage
- Water Softener System

See Our Full Product Line & Watch Videos at [www.cipp-services.com](http://www.cipp-services.com)

# All-In-One AIR INVERTERS

**Continuous Air Inversion  
No Deflation To Steam Cure**



- Units Available For 3" to 72" Diameter CIPP Liners.
- Apply Heat Within Minutes After Inversion
- Pressurized Internal Gland Lubricating System On All Units
- Rental Units Available
- Professional Training & Support

**Small Diameter Lining Equipment & Materials**



Phone: 815-712-8708 • E-mail: [sales@cipp-services.com](mailto:sales@cipp-services.com)

# THE ELECTRIC EEL® MODEL C DRAIN & SEWER CLEANER...

## BEATS THE DRUM!

### TRIED & TRUE, BETTER THAN NEW...

#### This Powerful Sectional Drain Cleaner Outperforms Drum-Style Machines

- Redesigned Quick-Connect Snap-Lock Cable Couplings
- No Down Time From Broken or Kinked Cables
- More Power and Twice the RPMs
- Less Cable and Tool Breakage
- 8' & 10' Sectional Cables
- Easy Transport By One Person
- Lower Maintenance and Much More
- All For \$100's Less!

**Don't Miss A Beat... Call Today!**



**vwett**  
BOOTH  
4156

# Electric Eel®

1-800-833-1212 [www.electriceel.com](http://www.electriceel.com)

DRAIN CLEANING TOOLS FOR PROFESSIONALS

Cleans 3"-10" diameter lines up to 200 ft.

Fold down handle allows easy transport, storage and use in crawl spaces.

Redesigned **Quick-Connect** snap-lock cable coupling allows cables to connect easier and quicker than ever. Now standard on all Electric Eel® sectional dual cables, regular and heavy duty, and totally compatible with all cables currently in use.



PATENT PENDING



**ARTHUR PRODUCTS CO.**  
ENGINEERED SOLUTIONS



*Int.r.* **KUT**  
SERIES

Designed & Manufactured  
by Arthur Products Co.

1.800.322.0510  
[apc@apclsq.com](mailto:apc@apclsq.com)  
[www.arthurproducts.com](http://www.arthurproducts.com)

**vwett**  
BOOTH  
1349

## Freeze-Up Problems?

Get The

## ARCTIC BLASTER

THAWING DEVICE

SIMPLE — SAFE — QUICK — CONVENIENT — ECONOMICAL

Have freeze-up problems? We've got the simple, low cost **ARCTIC BLASTER THAWING DEVICE** that thaws pipes above and below ground. The perfect winter tool for: rental shops, plumbers, battery operators, septic tank truckers, farmers, feedlot operators, native and remote housing, mobile home parks, electrical contractors, and more. Use on plastic, copper or ABS. Perfect for roof drains.



**ORDER IT TODAY!**

It will probably pay for itself the 1<sup>st</sup> day you need it.

**AUNTY SEPTIC SAYS...**

"Invest in this little money-maker for excellent winter profits! Give your income a big boost!"



**ARCTIC BLASTERS INC.**

SUNDRE, ALBERTA

403.638.3934 • Fax: 403.638.3734 • [www.arcticblaster.com](http://www.arcticblaster.com)

# SOUTHLAND TOOL MFG. INC.

*Building Innovative Tools for Municipalities*



## SOLUTIONS TO SEWER CLEANING THROUGH:

- **CONCEPT**
- **DESIGN**
- **PRODUCTION**

Manhole Tools • Debris Baskets • Vac-Traps • Root Saws  
Calcium Cutters • Sewer Rods • Handy Clams  
Nozzle Extensions • Deep Vac Tube Holder  
Grabbers Claws and Hooks • Diamond Tap Cutters  
Fiberglass Poles • Hydraulic Cutters • Top Manhole Rollers  
Sewer Spoons • Continuous Rod • Carbide Saws

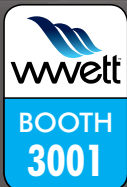

1430 N. Hundley St  
Anaheim, CA 92806

ph: 714.632.8198  
fax: 714.632.8228

[www.SouthlandTool.com](http://www.SouthlandTool.com)



# No Water? No Problem.

Innovative combo truck is always ready to start working — even with an empty water tank

By Ken Wysocky

Imagine a combination truck that could head out every day with an empty water tank — and never require stops to fill up, either.

Without time-consuming water refill runs, productivity and its close relative, profitability, would jump dramatically. With less cargo, gas mileage would improve while expenses such as fuel and water would decrease. Moreover, you could market your company as a truly sustainable, green-minded business that significantly contributes to conserving a precious natural resource.

Henry Sorensen, fleet manager for Cleveland-based C&K Industrial Services, doesn't have to imagine all that. It's his reality every day, courtesy of the RECYcler 315, an innovative water reclamation vac truck built by J. Hvidtved Larsen A/S in Denmark.

"There's no need to stop and hook the truck up to a fire hydrant," Sorensen explains. "Instead, the truck removes water from debris we take from a sewer line, then cleans it and reuses it. And we don't have to pay for water that comes from a sewer, which is significant to us because we can spend anywhere from \$1,200 to \$1,600 a week on water (for the company's 18 conventional vac trucks).

"We don't have to shut down on a job site to refill the water tank," he continues. "That's critical because sometimes we aren't close to a fire hydrant ... and you can waste half a day driving back and forth to fill up with water. As such, the RECYcler can usually outwork two of our other vac trucks — double our productivity."

C&K bought the RECYcler 315 about a year ago after seeing one at the Water & Wastewater Equipment, Treatment & Transport (WWETT) Show. The unit features a 2014 Kenworth T-800 truck chassis; a water pump made by Chemac Inc (URACA) (124 gpm at 2,175 psi); a vacuum pump made by CVS Engineering (1,825 cfm at 25 inches Hg); a hydraulic, swiveling hose reel that carries 660 feet of 1 1/4-inch-diameter hose; and a second hose reel for smaller-diameter hoses.

But two features set the machine apart from conventional vacuum trucks. The first is the water-recycling system. Here's a simplified explanation of how it works: The truck vacuums up water-filled sludge into the debris tank. The reclamation system sucks that water out of the debris, then sends it through a set of filters and cyclones that separate heavy solid particles. From there, the solids go into the sludge tank and water is pushed into the water tank, where it travels through another set of even finer filters. Then it's ready to be used for waterjetting operations, Sorensen says.

"It takes about 15 minutes to clean enough water to start jetting," Sorensen says.

"But we have to be cleaning a sewer with running water in it. If it's a dry



The RECYcler 315 jet/vac truck from J. Hvidtved Larsen A/S eliminates the need to stop working to refill the water tank. Instead, the truck removes water from debris, then cleans it and reuses it.

## money machines

**OWNER:** C&K Industrial Services, Inc.

**MACHINE:** RECYcler 315 water-recycling combo vacuum truck built by J. Hvidtved Larsen A/S

**FUNCTION:** Cleaning municipal sewer lines

**FEATURES:** 2014 Kenworth T-800 chassis; 13-cubic-yard debris tank with a moveable partition that increases debris capacity and decreases water capacity as needed, or vice versa; a water pump made by Chemac Inc (URACA) (124 gpm at 2,175 psi); a vacuum pump made by CVS Engineering (1,825 cfm at 25 inches Hg); hydraulic-powered, swiveling hose reel that carries 660 feet of hose

**COST:** About \$600,000

sewer, we have to bring water along. But if it has decent flow, there's no problem starting a job without any water in the tank." When a cleaning operation concludes, any water still in the tank gets dumped back into the sewer system.

The truck offers another unique feature: a pneumatically operated partition that allows the operator to make the water tank bigger and the debris tank smaller, or vice versa, as needed. At the start of a cleaning operation, the partition is positioned as far back as possible to allow for more water and less debris capacity. But the partition gets moved forward as work progresses, so the debris section gets bigger and the water section gets smaller. When crews complete a typical line cleaning, two-thirds of the tank is devoted to debris and the remaining third to water, he explains.

In addition to its water recycling capabilities, the RECYcler 315 features a pneumatically operated partition that allows the operator to make the water tank bigger and the debris tank smaller, or vice versa, as needed.



Moreover, in a typical cleaning, 90 percent of the debris is so dry that it's ready to be hauled straight to a landfill, with no need for time-consuming decanting, Sorensen says. "Eliminating that step makes us more cost-effective for customers," he notes.

In addition, the RECYcler 315's gas mileage is nearly twice as good as a conventional vac truck. And it operates so quietly that workers can talk to each other while standing next to it — a feature that allows C&K to do more nighttime work in residential neighborhoods, he adds.

"It's totally different to operate compared to a conventional truck," Sorensen points out. "It takes about two weeks of training for our employees to learn how to operate it. But they love the truck," he adds, noting another feature: a hydraulically powered suction hose that comes out the boom with no manual handling required. "No one needs to manhandle the hose — the machine does all the work."

All that efficiency and productivity carries a price tag of about \$600,000. But Sorensen says the investment is well worth it. The truck will pay for itself eventually through reduced operating expenses and increased productivity, and customers already are specifically asking C&K to use the RECYcler 315 on their jobs, he notes.

"Is it a game-changer? Absolutely," Sorensen says, noting that C&K — which also offers industrial cleaning services and operates in Indiana, Kentucky, New York, Ohio, Pennsylvania and West Virginia — recently placed an order for two more RECYcler 315s. "That should tell you how happy we are with this machine. It helps us tremendously in many ways, from job efficiency to sales efforts; once customers see what it can do, it sells itself. This is the future of vacuum trucks." **c**

# Why RST?

## "We get more footage for the dollar."

*--Frank F., Wastewater Collection Systems Manager*

single conductor CCTV inspection technology built to go the distance

[HGACBuy.com](http://HGACBuy.com)
 BOOTH 2431

**RST** Technical Services Inc.  
 Design and Manufacture of Video Pipeline Inspection Systems  
 cameras | tractors | vehicles | systems  
 THE SINGLE *conductor* SOLUTION  
 1800.767.1974 | [www.rstechserv.com](http://www.rstechserv.com)

### SHOW US THE MONEY (MACHINE)

Money Machines, a feature in *Cleaner*, reports on innovative work vehicles that help contractors operate more efficiently, satisfy customers and earn more profit. We'd like to know about your Money Machine — be it a service van, camera truck, jetting rig, vacuum unit or any vehicle that really helps drive your business. To nominate your vehicle for a feature in this column, send an email to [editor@cleaner.com](mailto:editor@cleaner.com). Tell us briefly but specifically what features make it a great producer. And send a picture — because appearance counts. We look forward to seeing your Money Machine.

collaborate · understand · deliver

# Demand More from Your Data.



It's what our industry has been waiting for—the power to share inspection results in real-time via the cloud, scale for big data, visualize system-wide condition with GIS, plan/track field operations via Google Maps, and generate high-level deliverables like heat maps, budgetary proposals and 3D system models.

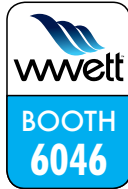

sold & supported by:

[www.pipelineanalytics.com](http://www.pipelineanalytics.com) • (877) 626-8386



real-time insight

## made in the USA Sewer Equipment Company of Nevada

Complete Parts & Service

- AMERICAN MADE
- Fast Shipping
- Call Us For A Quote

**(702) 527-5100**

Sewer Camera & Locators Packages Starting at \$2,199  
3 Year Warranty

Gas Engine Portable Jetters Prices Starting at \$2,699

Mainline & Mini Cameras Prices Starting at \$1,399  
3 Year Warranty

Electric Mini Jetters Prices Starting at \$1,199

Live Tech Support • Parts & Accessories Available For All Equipment  
[www.sewerequipmentcompanyofnevada.net](http://www.sewerequipmentcompanyofnevada.net)

**WE REPAIR ALL BRANDS OF SEWER CAMERAS**

# RHINO



- 8 lb. and 12 lb. (4140) ASTM A148 cast steel head breaks frozen covers free easily. Serrated edge strengthens pick-end and eliminates possibility of tool becoming bottlenecked in the cover.
- Combination sledge hammer and pick/pry bar. Two tools in one enables a worker to carry only one piece of equipment into the street
- Tapered saw-tooth pick fits 5/8" or larger drain holes and most pick slots.
- Top quality handle constructed of fiberglass.
- "Mary A" is patented.

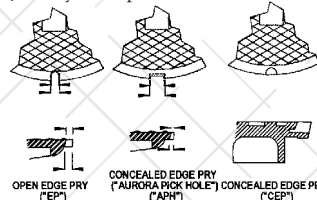

Distributed by:  
**DOUG MEADOWS COMPANY, LLC**  
1.800.588.3684  
Fax (325) 695-7954

Web site: [www.dougmeadows.com](http://www.dougmeadows.com)



UltraGreen™ from NLB

# Introducing the cleanest water jet power you can buy (or rent)



UltraGreen™

## EPA compliance and lower operating costs

Talk about a win-win: new UltraGreen™ water jet pump units from NLB cut emissions to near-zero, and typical users can **save over \$12,000 a year**.

UltraGreen units have Tier 4-compliant engines that meet the new EPA standards, reducing NOx and particulate matter by 90% or more. And since they use far less fuel, your operating costs are also dramatically lower.

Tier 4 certification isn't required everywhere yet, but

it will be. Get out in front with an UltraGreen water jet unit, available for sale or rent at all six NLB regional branches. Ask about our trade-in programs for older NLB units, too.

NLB already has over 350 low-emission units in the field, reducing costs while enhancing our environment. Give your business a competitive edge — call 800-441-5059 today.



The Leader in High-Pressure  
Water Jet Technology

29830 Beck Road, Wixom, MI 48393  
MI: (248) 624-5555, IN: (219) 662-6800, NJ: (856) 423-2211,  
LA: (225) 622-1666, TX: (281) 471-7761, CA: (562) 490-3277  
[www.nlbcorp.com](http://www.nlbcorp.com) • e-mail: [nlbmkgt@nlbusa.com](mailto:nlbmkgt@nlbusa.com)



# There's No Excuse for Trenching Accidents

Having a trained, competent person at the work site is critical to ensure worker safety

By Doug Day

**T**he risks, including death, are well known. Despite being easily prevented, cave-ins during trenching and excavation work continue to occur, killing an average of 40 workers every year. Whenever he hears of an incident, Ronnie Perkins says, "The first thing that comes to my mind is 'competent person.'"

Perkins, safety and education director for Associated General Contractors of Kentucky, stresses that a competent person is the last line of defense for workers and a company.

**"A lot of it is production related: There are only so many hours and minutes in a day. They figure all the extra work to do trench shielding or some kind of protective system is just not necessary, so they take a shortcut and it comes back to haunt them."**

Ronnie Perkins

"There's really not an excuse for anyone being injured in a trench accident," Perkins says. "When you trace it all back, you usually find that they either didn't have a competent person or that the person really didn't meet the definition. If you have a competent person who has thoroughly inspected the site, classified the soil, chosen the correct type of protective system, and trained all applicable employees in excavation and trenching safety, there should be no trenching accidents."



## Every day is Earth Day.™

"When we have a large rain storm there is so much infiltration into the sewer system, sewage treatment plants can be flooded. And if this overflows into the bay you have a problem. There are huge fines for dumping sewage into the bay, and a lot of cities have been going through inspecting and even doing grants for homeowners to upgrade their sewers."

**Denis O'Halloran**  
An Original Environmentalist  
President  
Southwood Plumbing & Heating  
San Bruno, Calif.

COLE publishing cleaner.com • 800.257.7222  
Proudly Serving the Environmental Service Industry Since 1979

Soil is very heavy; a cubic foot of soil can weigh over 100 pounds. Just 1 cubic yard of soil can weigh more than 2,700 pounds and easily kill or injure someone.

A competent person, says Perkins, is someone who is capable of identifying existing and predictable hazards or working conditions, and has been given authority by their employer to immediately correct any hazards. The competent person must be knowledgeable about the OSHA standards and the protective systems they choose to use, and must be able to:

- Classify soil
- Determine the correct type of protective system
- Monitor water removal equipment
- Test for atmospheric hazards when applicable
- Train all applicable employees in excavation and trenching safety

### PRODUCTION OVER SAFETY

Perkins says schedule pressure is a common cause of skipping steps that can easily eliminate the danger.

"A lot of it is production related: There are only so many hours and minutes in a day," Perkins says. "They figure all the extra work to do trench shielding or some kind of protective system is just not necessary, so they take a shortcut and it comes back to haunt them."

The consequences can be serious, obviously. Two companies were fined \$140,000 each last summer for the death of a 22-year-old worker killed in a Manhattan cave-in. Because they were aware of the situation and failed to remove employees even after being warned by safety officials on the project, officials of both companies were also indicted on manslaughter and other charges. Two companies in Texas were fined \$70,000 and \$18,000 in September for violations even though no accident occurred. In California, two construction companies that ignored OSHA stop-work orders in April were fined more than \$164,000 and \$140,000 for sending workers back into unprotected 11-foot excavations. "Safety has to be a line item in the budget. It has to be accounted for," says Perkins.

But it's not just a financial or production issue. "The first ramification is dealing with the families of the victims," adds Perkins. "What a company owner has to go through dealing with an employee's family far exceeds any kind of an OSHA penalty." **c**

# AMAZING MACHINERY

Your Equipment SUPERSTORE Since 1995

Introducing the  
**All New**

## Viztrac MAX

- 9" Color Flat Screen LCD in ABS Case
- Includes 12V Lithium-ion Battery (8-10 Hour Life)
- Built-in Digital Recorder with Remote Control
- Records to SD Card (4GB SD Card Included)
- Quality High Resolution Color Camera
- Camera Vision Angle Up to 60 Degrees
- 1.375 Inch Diameter "Easy Push" Camera Head
- Built-in 512Hz Sonde Transmitter (8-15 Feet)
- Stainless Steel Camera Body with Sapphire Lens
- Waterproof Camera Head
- 6 Super-Bright White LED Lights with Dimmer
- 12" Steel Spring Leader
- 3/8" or 1/2" Super Slick Push Cable
- Choose 100-225-foot Cable Length
- Heavy Duty Powder Coated Storage Reel
- Warranty: One Year Parts and Labor

FREE Freight

**8-HOUR,  
12-VOLT  
BATTERY**



**STARTING AT  
\$2395.00**

**6 Months, No Interest!**

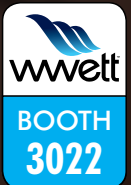

Get 6 Months to Pay on Purchases of \$99 or More.

Choose PayPal Credit® at Checkout. Subject to Credit Approval.



Complete Details At

[www.AmazingMachinery.com](http://www.AmazingMachinery.com)

**1-800-504-7435**

3807 Old Tasso Rd. • Cleveland, TN 37312



**TRENCHLESS SOLUTIONS**

[www.powrmole.com](http://www.powrmole.com)

SINCE 1956

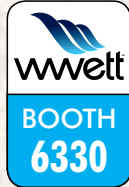

**We have been building the most economical and versatile horizontal boring and bursting systems on the market since 1956.**

**FOR INFORMATION CALL: 800-344-6653**

**STEERABLE • COMPACT • ECONOMICAL • PRODUCTIVE**

**Down time is expensive.**

*DO YOU HAVE A SPARE CABLE IN THE TRUCK?*



**AFTERMARKET CONNECTORS • CABLES**



*ALL* cables and connectors are individually inspected and tested before shipment.

**REASONABLE PRICES**

Seacon/  
Turck



504 738 7833 p/f • [jfowler307@aol.com](mailto:jfowler307@aol.com)

[www.OceanquipLLC.com](http://www.OceanquipLLC.com)

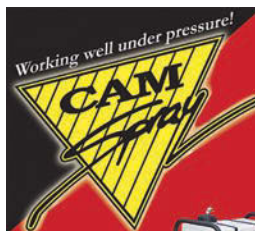

**Pressure Washers and Drain Jetting Equipment**



Skid and truck mount models up to 7000 psi



Portable Hot and Cold Water Diesel Powered Models



Hot and Cold Trailer Models  
Up to 7000 psi  
Flows up to 40 gpm  
Powered Reels  
Diesel powered models



**We will custom build to your specifications**  
[www.camspray.com](http://www.camspray.com) 800-648-5011

# lateral inspection takes a **new** direction

The patent-pending CleanSteer combines powerful propulsion, positive steering and bidirectional jetting to view and clean drains and laterals from any main line or clean-out.

Propelled by high-pressure water (1), CleanSteer snakes past multiple bends. A side jet is aimed remotely to steer through branches (2) and levitate over debris (3), and a forward jet can be pulsed to clear obstructions (4).

CleanSteer is ideal for locating cross-bores (5), pipe failures and blockages, all while jetting lines clean.



**FREE On-site Demo**  
Register at [www.pipelinert.com](http://www.pipelinert.com)



(973) 252-6700

an **Envirosight** company



Patents pending.  
©2016 Pipeline Renewal Technologies. All rights reserved.  
CleanSteer is a trademark of Pipeline Renewal Technologies.

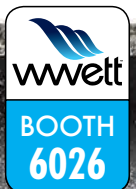



# bodus gmbh

## Pipe Technology

4344



**Pneumatic GRIPPER**



**AIR-HEATER**



**Cutter MICRO**



Visit our booths partners



4342/4343



5171

... from practical people  
for practical people

[www.bodus-usa.com](http://www.bodus-usa.com)

# VSI Rentals, LLC.

51 Stone Road Lindenwold, NJ 08021  
888-VAC-UNIT Fax: 856-627-3044

**2014 Peterbilt 348** cab & chassis with a 3,200 U.S. gallon, carbon steel, D.O.T. certified 412 vacuum tank; dump type with full open rear door and a Presvac PVB 750 vacuum-pressure pump.

**6 Available**  
**Price by Request**



**2002 GMC**, dual steer truck mounted, large capacity sweeper with dual sweep gear and catch basin cleaner unit  
**Price by Request**

**2014 Freightliner** truck mounted combination vacuum and jetter units  
**3 Available**  
**Price by Request**



**BOOTH**  
**4162**



**2014 Freightliner** truck mounted, industrial wet/dry vacuum loaders with 27" Hg blowers  
**4 Available**  
**Price by Request**

Scan the QR code with your smartphone



**All Units Available For**  
**Rent or Purchase**  
**888-VAC-UNIT**

# THE FORCE IS STRONG WITH THIS CABLE

**20% OFF ALL DURACABLE MANUFACTURED PRODUCTS!**

We feel that **DuraFlex™ Cable** from Duracable Manufacturing is the finest cable money can buy. Available in a wide variety of size and lengths, it's the cable you can count on to get the job done. Now, for a limited time, get **20% off** any of our tough, durable cable.

In addition, we're applying the **20% discount** to ANY item manufactured by Duracable Manufacturing. Machines, blades, accessories, and more.

Don't wait. The **20% discount** won't last long and it's a great way to save money

on some of the finest drain cleaning products made anywhere. Promo Code #511. Valid 2/1/2016-2/25/2016. Not valid with any other discount or offer.

**BUILT  
U.S.A.  
TOUGH**



**Just give us a call at 877-244-0556.**

The one-stop source for all your plumbing and drain cleaning needs – Duracable Manufacturing. Or visit us on the web at [www.duracable.com](http://www.duracable.com)

**Duracable**  
Manufacturing Company

# 8 Tips for Effective Delegation

Giving your team more responsibility will help your whole operation run smoother

By Eric Bloom

**Y**ou can't do everything yourself, no matter how good you are at your job. As a manager, you must delegate various tasks to your staff in order to do your job efficiently and effectively.

If you're on a lateral lining job, you're obviously not handling everything yourself. But you can't be on the job site and in the office at the same time, so sometimes you have to delegate. If you don't, you'll be overworked and your staff will be underutilized. In fact, you do a disservice to your staff if you don't delegate because it inhibits their ability to learn new things and grow as professionals.

Like all management activities, delegation must be done in a thoughtful and forward-thinking manner. To that end, consider the following tips when delegating tasks to your staff.

## 1. Clearly define what can and cannot be delegated

As a manager, be mindful of what should and should not be delegated. There are some tasks that your team members may not be qualified to perform, which is setting them up for failure. You don't want to just randomly

send one of your technicians out to do a job estimate if he or she has never had that responsibility.

Delegation is a powerful tool to maximize your team's productivity, enhance their skill set, help them grow professionally and free you up to perform higher level tasks. All that said — make sure you are delegating the right tasks for the right reasons. Don't just dump unwanted activities onto your staff to get them off your plate. Your team will eventually figure that out and it will hurt your credibility as a manager.

## 2. Create a prioritized delegation plan

Once you know what to delegate, your next step is to develop a plan outlining what tasks should be delegated to which staff member. When determining who gets which tasks, you should consider the following:

- Who is fully qualified to perform the task?
- Who could perform the task with proper instruction and mentoring with the goal of enhancing their skill set?
- Who should not be given the task because of their professional weaknesses and/or other attributes?
- Who deserves the task based on seniority, past performance and relevant considerations?

Delegating the right tasks to the right people is not always easy or popular, but if you do it with transparency, fairness, consistency and for the good of the company, your staff will learn to respect your decisions.

## 3. Provide clear instructions and define specific expectations

There is nothing worse than being delegated a task, not given instructions on how the task should be performed and what is expected, then working diligently to complete the task only to find out it isn't what was wanted. Give specific instructions and clearly explain your expectations. This combination of instructions and expectations provides the correct delegation framework and establishes criteria as to how your employee will be judged when the task is completed.

## 4. Provide a safety net

When delegating tasks — particularly if it's a new responsibility for the employee — as the manager, you must be willing to provide an appropriate level of management support to help ensure success.



If you delegate a task and then micromanage it to the extent that you have actually performed it yourself, it's not delegation. But don't totally divest yourself from the task either, because you're ultimately still responsible.



Create a safety net of help and protection by:

- Providing the needed resources and training.
- Allowing time to properly perform the delegated tasks.
- Helping employees navigate company politics.
- Providing instructions on how tasks should be performed.

#### 5. Let go and allow people to do their work

If you delegate a task and then micromanage it to the extent that you have actually performed the task yourself, it's not delegation. Neither should you totally divest yourself from the delegated task because, as the manager, you are still ultimately responsible for all work performed within your department. The trick is to walk that fine line between being overbearing and non-participatory.

#### 6. Be mentoring and instructive

This step provides direct instruction and advice to the person performing a specific delegated task. This type of task-based instruction provides an environment where employees can learn how to perform a specific task or deal with a specific situation.

The level of instruction and advice to be provided should be based on the combination of the person's specific experience and the task difficulty and importance.

#### 7. Give credit to those doing the work

As a manager, you should adhere to the philosophy of "it's the team's success or my failure." This philosophy causes you to raise the visibility of your staff's good work within the organization, which motivates them and helps instill loyalty toward you. This approach also helps remind you that you are ultimately responsible for both your team's growth and your department's productivity and performance.

#### 8. Actively solicit feedback from your team

Asking the members of your team if they believe you have delegated the right tasks to the right people has the following advantages:

- Helps you grow as a manager by learning how you are perceived as a manager.
- Helps improve your team's performance by providing you with insights on better ways to delegate and support your staff.
- Shows your staff that you are willing to accept their suggestions, making you more approachable as a manager.

For those not comfortable delegating tasks to others, be willing to go outside your comfort zone. Your willingness to take this leap will enhance your

department's productivity, enhance your managerial ability, and help your team expand their knowledge and skill. **C**

#### ABOUT THE AUTHOR

*Eric P. Bloom is the president and founder of Manager Mechanics LLC, a nationally recognized speaker, and author of the forthcoming book Productivity Driven Success: Hidden Secrets of Organizational Efficiency.*



### INTRODUCING THE NEW "GEN II" HEATER & STEAM UNIT FOR CIPP



Improved Heater Efficiency | Increased Air Flow Capacity | Increased Water Storage Capacity  
Wireless Data Acquisition System to Record Discharge Temperature and  
Upstream/Downstream Liner Temperature



Improved Heat Output/Efficiency | Larger Work Platform  
Wireless Data Acquisition System to Record Water Temperature,  
Flow Rate and Upstream/Downstream Liner Temperature

COME VISIT US AT THE W.W.E.T.T. SHOW, BOOTH # 1243.

**(800) 489-2397**

WWW.RUSHOVERLAND.COM

Quality equipment for the maintenance & trenchless rehabilitation of collection systems since 1983.

### Multisize Pipe Plugs

Pressure Testing, Blocking, Bypass Pumping



Factory replaceable sleeves available

### Logiball Test & Seal Packers

Stop infiltration through pipe joints & lateral connections in collection systems & prevent erosion of fines into the sewer.

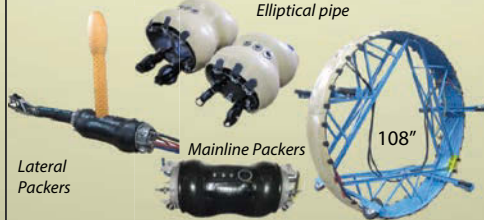

Lateral Packers

Mainline Packers

Elliptical pipe

108"

### Lateral Cleaning Launchers

Clean laterals from the mainline sewer as far as feet in the lateral.



### Carriers for Sectional CIPP Lateral Liners

Available for 3", 4", 5" & 6" pipes. Models available for bends & push rod option.



Factory replaceable sleeves available

### Multisize Flow Thru Carriers

For mainline cipp sectional liners 6"-36" pipes in lengths up to 25 feet



Factory replaceable sleeves available

### Flow Diversion Plugs

Model D plugs are ideal for manhole rehab

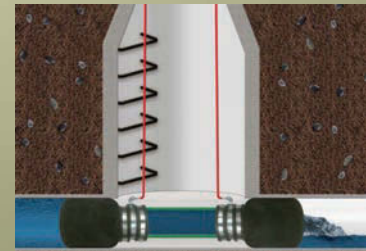

TEL: 1-800-246-5988

TEL: 418-656-9767

FAX: 418-653-5746

WWW.LOGIBALL.COM

# THE CABLE CENTER 1-800-257-7209

MIDWEST'S LARGEST FACTORY AUTHORIZED REPAIR CENTER FOR GATORCAM, GEN-EYE & SEESNAKE

**24**  
HOUR  
TURNAROUND

**FREE  
FREIGHT  
ON ALL RIDGID  
CAMERA  
KITS**

## RIDGID's CS10 Digital Recording Monitor

- USB Thumb Drive
- 12.1" Daylight Readable Display
- Multi Mode Recording  
take snapshots, record full video & lean video
- Software Integrations  
with SeeSnake HQ & RIDGIDConnect™



CALL FOR  
SPECIAL  
PRICING ON  
ALL CAMERA  
KITS!

THE CABLE CENTER · 8318 OLIVE BLVD. · ST. LOUIS, MO 63132 · 314-993-3099 · www.thecablecenterinc.com

# Parts, Parts, & More Parts



## Direct to You.

When you need parts in a hurry there is one source to remember – FS SOLUTIONS®. FS Solutions centers stock thousands of parts for all makes and models of vacuum trucks, waterblasting equipment and hydro-excavators. And FS SOLUTIONS is the authorized genuine OEM parts distributor for JETSTREAM®, GUZZLER®, and VACTOR® HXX®.

Parts are available at nationwide locations for pick up or quick shipment.



A proud member of the Federal Signal Family.

FS Solutions® Vactor® HXX® Jetstream® and Guzzler® are registered trademarks of Federal Signal.

[www.fssolutionsgroup.com](http://www.fssolutionsgroup.com) 1.800.822.8785

© 2015 Federal Signal Corporation

# the enz<sup>®</sup> BULLDOG<sup>®</sup> Your Best Friend!

Application range:  
2.5" - 24"

400.037    400.060    400.080    400.101

This all-purpose nozzle is the most efficient and economical way to clear roots, debris and blockages from your pipes.

- Utilizes both fresh and recycled water
- Easy to handle and low maintenance
- Reduces transportation and water costs
- Oil-free braking system provides low wear and tear operation

**wwett**  
BOOTH  
1197

**enz<sup>®</sup> usa inc.**  
1585 Beverly Ct., Unit 115 | Aurora, IL 60502

CALL 1 877 ENZUSA1 For a dealer near you  
[www.enzusainc.com](http://www.enzusainc.com)

## Inside The Pipe "GRIPPER" Tool



### Easy To Use Pneumatic Tool For Grabbing Objects in Sewers & Ventilation systems

- Makes 90° Bend in 4" Pipe
- Air Powered (15psi) Operation up to 82' Standard or Longer Distances Possible (Option)
- Fast & Simple Maintenance
- "No" detection needed
- Camera Hook Up Optional
- Easy In/Out using Fiberglass Push Rods, Cable or Sectional Rods
- 2.16" dia. x 9.45" length - Weight 10#
- Comes with Pliers Teeth Grabbers

Cost \$2400.00 + Freight

**CLOVERLEAF** Tool Co.<sup>®</sup>

"Quality Products at Affordable Prices"  
P. O. Box 110757 • Bradenton, Florida 34211 USA  
Toll Free: 800-365-6583  
Tel: 941-739-0707 • Fax: 941-739-0001  
[www.cloverleaftool.com](http://www.cloverleaftool.com) • email: [sales@cloverleaftool.com](mailto:sales@cloverleaftool.com)



## AVOID HIGH START UP COSTS...RENT!

CIPP EQUIPMENT & MATERIALS  
SALES | RENTALS | TRAINING

- Shooters
- Packers
- Cutters
- Trailers
- Training
- Materials
- Boilers
- Refrigerated Delivery



**TTS** TRENCHLESS SOLUTIONS



[www.trenchless-inc.com](http://www.trenchless-inc.com)



267.812.5855 | 1.855.LINE.TSI

We travel coast to coast for training and labor support!

# SCOOTER

VIDEO  
INSPECTION SYSTEMS

20843 Santa Lucia • Tehachapi, CA 93561 • Fax: 661.822.8917

We are celebrating our

25<sup>TH</sup> ANNIVERSARY

With A **25% OFF** SALE as a THANK YOU to our customers

Tired Of Squinting  
At A Tiny Monitor?

Get An Attaché  
With A **15" LED**  
Hi-Def  
Monitor

**"Simplify your life!"**

SCOOTERS ARE EASY TO USE, TOUGH AND DEPENDABLE.  
DON'T LEAVE THE SHOP WITHOUT ONE.



The new Scooter Attaché 1+ now includes a giant 15" LED hi definition color monitor as well as a high quality SD/DVR recorder, and has the capacity to operate other camera systems too!



800.772.6165

[www.tvinspection.com](http://www.tvinspection.com)

# Pressure and Flow

Determining which water jetter best suits your needs requires some calculated thinking and an eye to the future

By Ken Wysocky

**T**he right jetter can have a direct and significant impact on your bottom line, but knowing which is the right jetter requires an understanding of functions, features and your own needs.

First, it's important to understand the basic principles of waterjetting — pressure and flow. Measured in psi, pressure refers to the force with which the water is propelled through a hose via a high-pressure pump. Water is forced through small holes in a nozzle/cutting head that does the cleaning. Flow, measured in gpm, is a function of horsepower and pressure and refers to the volume of water going through the hose, which carries away dislodged debris.

In general terms, larger-diameter pipes require higher flow, while smaller pipes require higher pressure.

Brian Gilbert, the national sales manager for Harben, which builds a wide range of water jetters, says contractors need to think carefully about the future. “You might be interested in just residential work right now, cleaning only 3- to 6-inch-diameter lines, but where do you see your company in five years?” he asks. “Do you want to bid on municipal or commercial jobs with 10- to 12-inch drainlines or larger industrial pipes? And what about storm drains, which are up to 36 inches in diameter? You can't do that with a machine that generates 4,000 psi at 18 gpm. Bigger pipes require more flow, so 4,000 psi at 25 gpm would work better for some of those applications.”

The bottom line: Don't buy an undersized machine, Gilbert advises. “You need to try to look into the future, which isn't easy to do.”

## MODIFICATIONS AND CONSIDERATIONS

But if contractors invest in a much larger unit, don't they give up the option of cleaning smaller lines? Not necessarily, Gilbert says, thanks to a technological advancement called a flow diverter. A flow diverter can be set to divert a specified amount of water back to the water tank, which reduces the flow output. This enables a contractor with, say, a 4,000 psi/25 gpm water jetter to drop the flow down far enough to switch to a 1/4-inch hose and clean smaller-diameter pipes. “It essentially gives you more versatility,” Gilbert says.

Spartan jetters basically accomplish the same thing via an unloader valve, also known as a pressure-relief valve. It can reduce the flow on a large jetter from 18 gpm down to 3 gpm, for instance — low enough to switch from a 1/2-inch-diameter hose to a 1/4-inch hose that can be used to clean a kitchen sink drainline, for example.

“The unloader regulates what you need and sends any extra water into a holding tank,” Gage says. “Then you can use an auxiliary reel to step the larger hose down to a smaller hose with a smaller nozzle.”

Other factors require some thought, too. What kind of material or debris and what size pipes will you be dealing with the most? If it's 3- to 4-inch lines filled with rock and sludge, a smaller cart-mounted, electric-powered jetter won't do the trick. Do you often have to cut through tree roots? If so, you'll need a powerful, high-pressure unit. And how long of a hose run will your typical jobs require? Since water pressure tends to drop as the hose run increases, a more powerful unit is needed to compensate for longer runs, Gage notes.

“You also need to keep in mind that our jetters' pressure ratings are measured at the end of the hose,” he says. “If you're looking at a machine with 4 gpm at 3,000 psi — which usually comes with 200 feet of hose — that 3,000 psi is measured at the end of the hose. If you add more hose, you lose about 1 pound per foot, on average. A lot of jets are rated right at the pump, so guys looking at getting into jetting should ask where the water pressure is rated at, the pump or at the end of the hose.”

**“Do you want to bid on municipal or commercial jobs with 10- to 12-inch drainlines or larger industrial pipes? And what about storm drains, which are up to 36 inches in diameter? You can't do that with a machine that generates 4,000 psi at 18 gpm.”**

Brian Gilbert

“If you mainly clean bigger lines, you need more flow to flush out all the debris,” says Tim Gage, the Ohio territory manager for Spartan Tool, which offers a full line of jetters aimed at various applications. “For smaller lines, you usually want more pressure, especially if you're cleaning heavy greases or clearing tree roots.”

A smaller cart-mounted jetter with a 1.5 hp electric motor generates about 1,500 psi at 1.5 to 2.25 gpm and is suitable for cleaning pipes up to 4 inches in diameter. In other words, these smaller units are best suited for cleaning interior residential lines. If you mostly tackle lines up to 6 inches in diameter, a 13 hp unit (with a gas-powered engine) that generates 3,000 psi at 4 gpm should do the trick. And to clean lines ranging from 3 to 12 inches in diameter, you'll need an even larger trailer-mounted unit with a gas engine that ranges from 19 to 40 hp and produces anywhere from 2,000 to 4,000 psi at about 12 gpm. For even larger pipes, the horsepower and gpm metrics increase exponentially while the pressure specs remain in the 3,000 to 4,000 psi range.

The kind of pipes commonly found in your area could also influence your decision. PVC pipe can withstand higher-pressure jetting. Old Orangeburg pipes? Don't even think about it. "And if you run into a lot of galvanized pipes, especially in restaurants, they often develop 'bellies' where the pipe has been eaten away," Gage says. "Sometimes a jetter will cut right through there."

If you buy a bigger trailer-mounted jetter, you also have to consider your vehicle's towing capability. "Some of our larger water tanks go up to 600 gallons, which comes out to 8 pounds per gallon for just the water alone, not including the tank," Gage says. So you may need to factor the cost of a new truck into your decision. On the other hand, you can typically charge customers more money when using a larger jetter, plus they enable you to finish jobs faster. That, in turn, allows you to do more jobs per year and make more money, he says.

"On our website, we have a calculation chart that allows you to enter the (monthly) payments for a machine, plus estimate material and labor costs, and it calculates what the machine can earn for each job," Gage says. "So if a guy is looking at a \$20,000 machine but really wants a \$40,000 machine, he can do the calculations and maybe he finds out it costs only \$100 a month more for the larger machine."

Gilbert also recommends considering more than just the jetter's price. "First of all, you get what you pay for," he says. "Price is always a factor, but at the same time make sure you study and learn what everyone is producing. Look at warranties. Talk to others who have purchased and operated the same machine. Get references. Do your homework. Don't buy a machine just because it's \$3,000 cheaper than another one."

Contractors also need to consider the cost of ownership. For example, one jetter may cost less than

another, but the lower-cost model might include a less durable pump that will incur ongoing costs for periodic rebuilding or even replacement, Gilbert says. "There's also a cost to the resulting downtime for repairs." **C**

**>> FOR MORE <<**  
 on jetter setup, operations  
 and nozzle selection, check  
 out the full four-part series at  
[www.cleaner.com/jetting101](http://www.cleaner.com/jetting101)

**because  
 a lot is  
 riding  
 on your  
 data...**

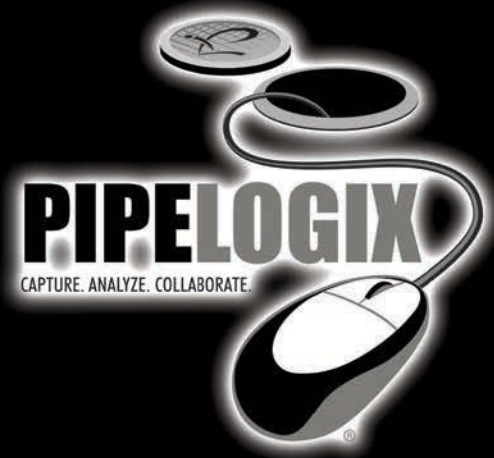

**You're responsible for  
 helping manage your  
 community's vital  
 resources and services.  
 Collecting pipeline survey  
 data is only the beginning.**

PipeLogix's array of analysis tools and reports gives contractors and municipalities the insight to make good decisions and take action where and when it can do the most good.

With built-in tools to share information across departments and other programs like GIS and popular asset management suites, your teams can manage systems more effectively.

Call today or visit us at the expo to learn more about our tools to assess and understand underground assets.

866.299.3150 | 760.779.1700 [www.pipelogix.com](http://www.pipelogix.com)



Our Business Partners:



The highest quality sewer inspection video equipment the market has to offer.



### Portable System



- 7.4" Daylight readable monitor
- Adjustable lighting
- On-screen text writer and footage counter
- 512Hz SONDE transmitter
- Wi-Fi video transmitter for recording
- 5 Volt charger port , RCA video out jack
- 12 Volt removable Lithium Ion battery pack with internal charger
- Operates on 12 volt power supply or battery pack and charges the battery while running
- Battery level indicator lights
- Small compact size with 125 feet of push cable
- Internal drum brake
- Can be used horizontally or vertically
- Self leveling camera heads available
- Optional USB recording available

### Wi-Fi System



- Premium wound push rod
- Self-leveling and mini camera heads available
- 512Hz Sonde (on/off button)
- Adjustable Lighting
- On screen footage counter (Feet & Meters) (Resettable)
- 8 Page text writer with memory save
- Mobile device holder and keyboard guard
- 12 Volt removable Lithium Ion battery pack with internal charger
- Operates on 12 volt power supply or battery pack and charges the battery while running
- Battery level indicator lights.
- USB port for charging mobile devices and RCA video out jack

Visit booth **5041** or [www.hathorncorp.com](http://www.hathorncorp.com) for more info and products / **905-604-7040**

Your TRUSTED Lateral Lining Manufacturer!

**Quik-Lining Systems**

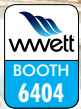

★ ★ ★  
**CALL TODAY!**  
605-695-6778  
★ ★ ★

Quik-Lining Systems offers a revolutionary line of Lateral Lining Inversion Equipment for the installation of **Cured In Place Pipe**.



Our equipment saves **TIME and MONEY**

Can be used in even the most confined spaces!

CONTACT US FOR MORE INFORMATION // 605-695-6778

[WWW.QUICKLINING.COM](http://WWW.QUICKLINING.COM)  
E-MAIL // [JOHN@QUICKLINING.COM](mailto:JOHN@QUICKLINING.COM)

## Professional-Grade Drain Cleaning Machines, Cables & Accessories



### Drain Cleaning Machines

- > Heavy duty construction
- > The most powerful motor in the industry
- > Quick and easy reel changeover
- > A one year rock-solid warranty

### Cables

- > Fabricated from high quality wire
- > Most ends & couplings available
- > All sizes and lengths
- > Innercore available



**COAST MANUFACTURING**

[www.coastmanufacturing.com](http://www.coastmanufacturing.com)  
**1.800.541.7015**



# Blast More



## Introducing Jetstream's 650hp TwinForce™ and 600hp 6000 Series Water Blasters

Our two new high flow, high horsepower water blasters pack a punch with up to 650 HP and have the power and reliability to make your job easier. They also come with the Jetstream® RightStart® training program as well as nationwide service support, parts and accessory availability, and water blasting application expertise - so you can focus on your business and increasing productivity.

To learn about how Jetstream can improve your productivity, call 800-231-8192 or visit [www.waterblast.com](http://www.waterblast.com).



**GUZZLER**

**FS Solutions**

**VACTOR®  
HXX**

**Jetstream®**

A proud member of the Federal Signal Family.

© 2015 Federal Signal Corporation

[www.waterblast.com](http://www.waterblast.com) 1.800.231.8192

Jetstream® TwinForce™ and RightStart® are registered trademarks of Jetstream of Houston, LLP.

# Mainline Inspection in a Compact Package

IRIS robotic crawler camera provides versatile solution for inspecting range of pipe sizes

By Craig Mandli

**W**hen drain cleaners perform mainline pipe inspections, equipment that provides ease of use and versatility is the name of the game.

That's the message Insight Vision Cameras is sending out with the introduction of the IRIS (Integrated Remote Inspection System) mainline crawler camera. The unit was featured at Insight Vision's booth at the 2015 Water & Wastewater Equipment, Treatment & Transport (WWETT) Show.

"This is a system that was designed for budget-challenged municipalities, municipal contractors and larger plumbing operations," says Bob Masse, Insight Vision's sales manager. "It's a system that has many different uses and functions, and can take the place of several camera systems."

**"This is a system that was designed for budget-challenged municipalities, municipal contractors and larger plumbing operations. It's a system that has many different uses and functions, and can take the place of several camera systems."**

Bob Masse

The IRIS Windows app-operated mainline crawler can be used to inspect pipes from 6 to 12 inches, and up to 18 inches with a larger wheel set. The ultra-portable and heavy-duty unit comes with 1,000 feet of advanced tether cable, pan-and-tilt capability, and a 10-inch LCD touch screen. The system includes a six-wheel-drive transporter and uses four powerful LED lights to illuminate a large area. Video will display on the reel unit as well as an external monitor via HDMI or a dedicated Wi-Fi-enabled Windows tablet, allowing easy file management and post-software reporting.

"This system allows a technician to stream the inspection feed directly to the touch screen in real time, or to a customer's laptop, PC or tablet via the HDMI hookup," says Masse. "In essence, the system itself serves as a computer. We believe that keeping the customer in the loop from the beginning is very important."

The camera and transporter are controlled via a hand-held pendant. The crawler has various wheel size packages available, and its high-grip rubber wheels allow it to traverse demanding conditions and terrain. It has an automatic free-wheel clutch for simple usage, and a manual lift comes standard. The motorized drum holds the flexible multi-conductor video cable and can operate automatically when in rewind mode, allowing the cable to be rewound at the same speed as the crawler to avoid running over the cable.



Peter Chandler, left, manufacturing manager for Insight Vision Cameras, explains the features of the IRIS mainline crawler app to an attendee at WWETT 2015. The inspection system offers compatibility with smart devices. (Photo by Craig Mandli)

The motorized drum is built with a telescopic handle and wheels for easy portability.

"We designed the IRIS to be easily portable and able to be operated by a two-man crew," says Masse. "It is the culmination of everything our customers say they want in a portable mainline inspection system."

Masse says the company decided to roll out its marketing campaign on the IRIS at the WWETT Show mainly to get feedback from what he called his company's "core audience."

"The attendees at WWETT are definitely the people we're marketing this system to, so this was the perfect opportunity to get it out there and talk about it," he says. "The people I talked with were excited about the portability of the system and the price point. We wanted to get people talking, and we certainly accomplished that."

Masse says the company plans to use the feedback received at WWETT to upgrade its product line. "We want to increase the functionality of the app and how it integrates smart technology into the system," he says. "We are planning some subtle changes to the crawler on the unit, too, that will make it more user-friendly. We plan on rolling those changes out at the 2016 show. We're looking forward to it." 800/488-8177; [www.insightvisioncameras.com](http://www.insightvisioncameras.com). **c**



# GORLITZ SEWER & DRAIN INC.

Norwalk Blvd. Santa Fe Springs, Ca. 90670

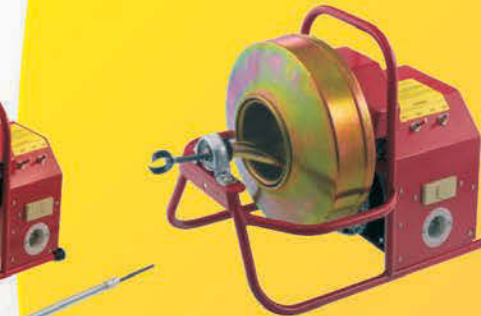
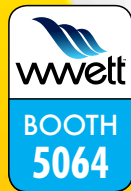

**MACHINES  
FEEDERS  
CABLES  
RAMPS  
CONNECTORS  
LEADERS  
CHUCKS  
ENDS  
RETRIEVERS  
SPLICES  
AUGERS**



**JETTERS  
NOZZLES  
HOSES  
TRENCHLESS  
PIPE SYSTEMS**



**SOCKET  
FUSION KITS**



*Engineering, Dedication, Quality, Sales and Service All In One Stop!*

www.gorlitz.com  
Email: sales@gorlitz.com  
f GORLITZ on Facebook



Tel: (562) 944-3060  
Fax: (562) 944-7630

# Pulsar 2000 Line Tracer

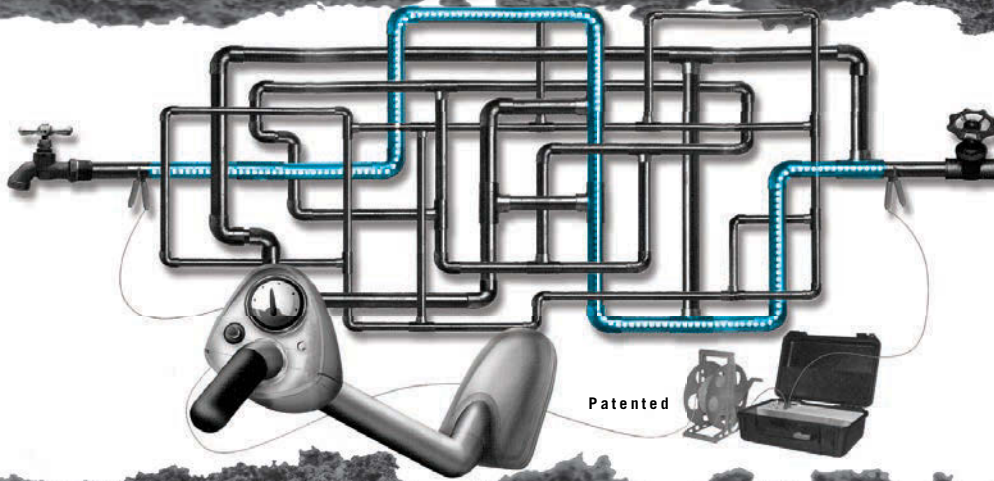

Patented

Locate Lines  
Locate Water Leaks  
Training Video

*It's a jumble out there.*

[www.Pulsar2000.com](http://www.Pulsar2000.com)  
DISTRIBUTORS WANTED



The Pulsar 2000 line tracer is designed primarily to locate metallic pipes. The Pulsar 2000 is a directional line tracer. Connect the Pulsar's powerful and unique transmitter to your target pipe and locate only that pipe. Locating can be accomplished under floors, in walls and in ceilings. The Pulsar 2000 does not require grounding.

**Leak detection personnel...** The Pulsar 2000 is a must have locator. Now you can quickly identify the pipe location, thereby reducing the search area of the leak.

**100% satisfaction guarantee...** We are so sure that you will see the time saving benefit of the Pulsar 2000, we will let you return it for a full refund if you are not satisfied. If

you want to learn more about the Pulsar 2000 and our leak locating equipment, please call 1-888-752-5463 or e-mail [jsml@aol.com](mailto:jsml@aol.com) for a free demonstration video or CD and references of satisfied customers.

We have been using the Pulsar 2000 along with the XL2 fluid detector and Geophones since January 1989 in our leak locating business. Our leak locates are **accurate 95% of the time**, but I can honestly say, the line we trace is always there. Our equipment is user-friendly and requires very little training, as you will see on the video. Purchase the Pulsar 2000 line tracer, XL2 fluid detector and Geophones, and start locating leaks immediately.

## YOUR SOURCE FOR RIDGID



CS6 Digital  
Recording  
Monitor



CS10 Digital  
Recording Monitor  
with Flash Drive



LT1000 Laptop  
Interface System



SeeSnake®  
Compact 2  
Camera  
Reel



SeeSnake® MAX rM200  
Camera System



DVDPak



microDrain Reel

CENTRAL OKLAHOMA

# Winnelson

COMPANY

**8% ONE YEAR FINANCING AVAILABLE!**  
Longer lease rates also available. Call Keith for details.

**BUYING A SEESNAKE?**

**CALL KEITH  
FOR SHOW  
SPECIALS**

**WE  
WILL NOT BE  
UNDERSOLD**

- Call Us Evenings and Weekends -

Keith: 405-602-9155 &

Jim: 405-205-3974

CALL TOLL FREE: **888-947-8761**

5037 NW 10th  
Oklahoma City, OK 73127

[www.centralwinnelson.com](http://www.centralwinnelson.com)

# WINTER READY?

wwelt BOOTH 3217



*4025 Dual Reel Truck Unit*

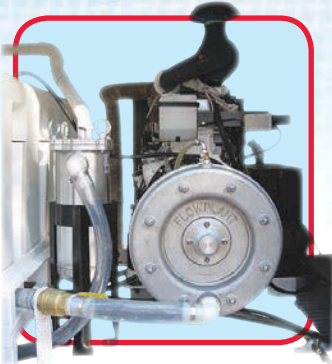

*Harben Q Pump  
4025 Performance*



*NEW 4018 Van Pack*

Experience the Harben difference

**QUALITY**

**VALUE**

**SERVICE**

**RELIABILITY**

Call today to schedule a demonstration. **1-800-327-5387**

 **HARBEN**<sup>®</sup>  
**High Pressure Water Technology**

[www.harben.com](http://www.harben.com)

Scan the code below with your smart phone application





Erik Gunn is a magazine writer and editor in Racine, Wisconsin.

# Whom Should You Trust With Your Money?

When it comes to managing your retirement funds, know the differences between a fee-only financial planner and a commission broker

By Erik Gunn

**Y**our business is growing, and you're earning enough money to set aside and begin building some wealth.

Sticking it in your mattress is just an old cliché, banks don't pay much interest, and while the broker down the street may help point you to a great stock pick, that's still just a piecemeal approach to managing your money for the long term.

So when it comes to gaining the big-picture perspective, where do you turn for advice? If you're hiring a professional to help you protect and grow your personal wealth, you have a couple of basic choices.

Many people simply turn for investment advice to that same (successful, we hope) broker, buying or selling stocks or other securities based on that person's recommendations. The broker might even offer a big-picture approach, helping choose investments that are more secure as you age so that the downside risk to your nest egg declines as retirement nears.

There's no doubt that many such professionals try to do their best to make fair and thoughtful decisions for their clients. And since they're paid largely on commission with each trade or within mutual fund charges, it's easy to feel like their service is practically free. It's not, of course. Commissions themselves amount to something, however small. But there are bigger reasons to consider an alternative approach: the fee-only financial planner.

## PAID FOR TIME, NOT FOR TRADES

The term means just what it says. Fee-only planners get paid *not* for buying or selling investments on your behalf, but for reviewing your financial assets and goals and making recommendations accordingly. Those recommendations are based on their knowledge of the investment markets and their understanding of your particular circumstances.

Yet how they're paid just scratches the surface when it comes to really understanding the difference, says Michael Haubrich, financial advisor based in southeastern Wisconsin and member of the National Association of Personal Financial Advisors (NAPFA.org).

"The bigger distinction is not the compensation, but what it really is, is the person you're dealing with acting as a fiduciary," Haubrich points out. To put it in plain English — is the professional required under the law to act in the client's best interest?

The traditional stockbroker is governed by the federal Securities Exchange Act passed in 1934. That law requires the broker to fully inform clients about the "suitability" of an investment, including pointing out the risk that any particular investment might wind up becoming worthless.

A separate law passed in 1940 sets a higher standard for *registered investment advisors*, a group that includes fee-only planners; they are obliged to tailor their advice to the client's best interest. Simply disclosing risk and

advising investors to consider the suitability of a particular investment isn't enough.

"We do a deep dive into what the client's objectives are and what their risk tolerance is," explains Haubrich, whose business is Financial Service Group Inc. "We can be held liable if we can't demonstrate that the advice we give is in the best interest of the client."

Based on information collected from the client, a fee-only planner might recommend a particular stock, but she or he won't get paid differently based on whether the client decides to follow through on the recommendation. As a consequence, the planner has no incentive to push any particular investment.

## METHODS OF PAYMENT

Of course, the planner gets paid in some way — and typically up front, so their services cost more at the outset. Some planner fees are structured on the basis of hourly charges or through a system of retainers that cover a certain amount of service before they must be renewed — just as business lawyers typically are.

Most planners, though, set their fees on the basis of a percentage tied to the total value of the assets managed for the client. A 2013 survey by the trade publication *Investment News* found that fees go down as the assets under management go up; for \$100,000 to \$500,000 in assets, expect to pay about 1.5 percent per year; people with \$5 million under management paid on average less than 1 percent per year.

That brings up another wrinkle in the ever-evolving investment advisor world, Haubrich notes.

Many brokerage houses, recognizing the concerns people may have about the objectivity of advice coming directly from a securities dealer, are establishing separate arms staffed by advisors paid ostensibly solely on the basis of a percentage charged against the assets they're managing, like fee-only planners.

He points out, however, that those advisors often get some form of additional commission relating to investments that are conducted through their employers, distinguishing them from the true fee-only planner.

"From the consumer's point of view, they all look the same," Haubrich observes. "They all wear suits, they all wear ties." But when it comes to the way they're actually paid — and the incentives that might influence their advice — "that is not a subtle difference."

Wall Street, he notes, has been lobbying heavily to derail proposed federal Labor Department regulations affecting businesses marketing investment platforms for company 401(k) defined contribution pension plans. The feds are arguing those firms should be held to the fiduciary standard — serving participants according to their best interests — rather than the less strict

CONTINUED >>>



## World-class quality, portable package.

Rausch has offered premium inspection equipment worldwide for over thirty years. Our advanced camera systems include modular upgrades for laser profiling and lateral launching, all from a single tractor platform.

Rausch is proud to introduce the **Mobile Pro**, our new portable mainline system. The system features a lightweight cable reel and built-in 12" monitor and control unit in a 17-inch square footprint.

Featuring the Cubix 300 motorized cable reel loaded with up to 1,000' of cable, our new mobile TV inspection system provides a professional and cost-effective solution that can fit in the bed of a truck or ATV.

The high quality Rausch C135 camera/tractor unit is industry-breaking, allowing the new Mobile Pro system to outperform systems four times its size.

[www.rauschusa.com](http://www.rauschusa.com)



# **rausch** USA

**RauschUSA**  
4757 Innovation Way  
Chambersburg, PA 17201  
Office: 717 709 1005  
Toll Free: 877 Rausch1  
[reusa@rauschusa.com](mailto:reusa@rauschusa.com)

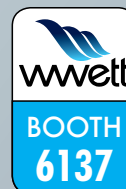

Join A National Brand  
**ROOTERMAN.COM**

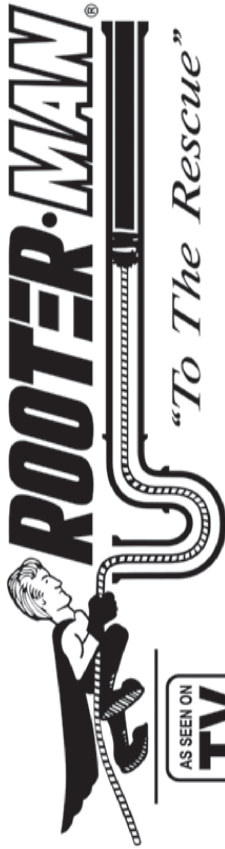

Without Paying the National Brand Price

**NEW CONCEPT: NO ROYALTY ON PERCENTAGE OF SALES**

**Reserve Your Exclusive Territory**

**Call 1-800-700-8062**

**FRANCHISE PACKAGE \$3,975.**

disclosure and suitability standard; the industry behind those plans, of course, would prefer a less strict standard.

**THE BIGGER PICTURE**

Finally, fee-only planners do a lot more than simply tell you what stocks or bonds to buy or sell.

Indeed, as more and more average people are getting comfortable with discount, do-it-yourself brokerage services, and as even more complex financial advice is starting to become automated in the form of online calculators that help people begin to understand the big picture of their own financial condition, some fee-only planners are offering a more comprehensive approach.

Haubrich, for example, views himself these days as helping clients with “life transitions.”

“We’re financial life planners,” he says. “We really focus on the client’s life, where they want to go and what they want to do in their life. Then we align their resources, not only their financial resources but their career assets, to make sure there’s good alignment to help them get through whatever life transitions they’re in now.”

That can include not just giving advice about investments but connecting clients with other sources of guidance such as work and career counselors and other kinds of advisors.

Such broadly based advice may be a lot more than you’re looking for, of course.

Still, if you’re in the fortunate position to have assets in need of management, it behooves you to think carefully about what sort of advice you want, and how you want to pay for it. **C**

**TROJAN**  
WORLDWIDE INC.

**MADE IN USA**

**Now Manufacturing**

All Sizes of Replacement Cables and Couplings for **MARCO** type Machines



\*Cables are Right Hand Wound

**New Product for 2016!!**  
**Mini Self-Leveling Color Camera Head**



- 1-1/8" Self Leveling Color Camera head
- Built in 512 HZ Transmitter
- Compatible with Camera Reels shown in Fig. A

Fig. A



New Equipment



Cables for Any Brand



Replacement Parts

Call **800-392-4902** or visit us at **www.trojanworldwide.com**



VISIT BOOTH  
#5230



## When jet/vac versatility counts, count on a proven performer

No other jet/vac combination sewer cleaner can compare with the proven performance advantages of Vacall's AllJetVac models, with reliable positive displacement power. More vacuum power up to 27" hg. More jetting power up to 120 gpm. Simplified operation. Lifetime warranties on aluminum water tanks and optional galvanized debris tanks. Standard AllSmartFlow smart controls. Single-engine savings on fuel, maintenance and emissions. And host of options including a new water recycling system. Best of all, each model is designed, built and supported with legendary Gradall quality.



 NEW  
Water Recycling Option

Call 800-382-8302 to learn why nothing works like a Vacall.

# POSITIVE SOLUTION

**GREEN**  
THAT WORKS



[VACALL.COM/AJV](http://VACALL.COM/AJV)



# Field and Office Technology

By Craig Mandli

## BUSINESS SOFTWARE FOR BILLING

### CLEAR COMPUTING BUSINESS INTELLIGENCE DASHBOARD

The cloud-based **Business Intelligence Dashboard** from **Clear Computing** combines data, charts and ad hoc reporting to provide at-a-glance, interactive summaries of the state of a business. With just a few clicks, busy managers and owners get key financial and operational information needed to make important business decisions and take action. Charts include customer gains and losses, month-to-date and year-to-date sales with comparisons to last year, a collections analysis, and trends and forecasting. Full ad-hoc reporting is included in CRM, sales, receivables and inventory control. Easily create, save and reuse reports designed with the data. **888/332-5327; www.clearcomputing.com.**



Clear Computing

### POINT-OF-RENTAL SOFTWARE RENTAL MANAGEMENT SYSTEM

**Point-of-Rental Software's** rental management system has been integrated with the **ECi Software Solutions RockSolid** business management system for hardware dealers to help streamline operations for customers who offer retail and rental inventory. Rental transactions take place seamlessly with payment and accounting processed within the **RockSolid** system while **Point-of-Rental** handles rental contracts, reservations and returns, as well as taking reservations with an integrated online store that updates inventory in real time; displaying current and future inventory availability; setting special pricing such as seasonal, holiday or weekend rates; scheduling rental inventory maintenance and tracking repair costs; defining kits, packages or suggested items; social sharing features; automatic email notifications for important events; reporting and analysis; real-time updates of deliveries and pickups through **Android** and **iOS** apps; and email and in-person electronic signature with tracking and verification. **800/944-7368; www.point-of-rental.com.**



Point-of-Rental Software

### RETRIEVER COMMUNICATIONS BARKING FOR SERVICE

**Barking for Service** from **Retriever Communications** is a mobile application designed to ensure technicians have critical job and customer information available. Users are guided through a natural workflow to capture

job data — including photos, attachments and signatures — that is sent back to the office in real time for immediate invoicing and reporting. It replaces paperwork in the field, increases workforce visibility and minimizes expenses, allowing a business to function more efficiently, according to the company. The application runs on **iOS**, **Android** or **Windows**, and can integrate into multiple back-end systems. **281/566-2528; www.retrieverbarking.com.**



Retriever Communications

## ROUTING

### ROUTEOPTIX BING MAPS

**RouteOptix** now integrates with **Microsoft Bing Maps**, enabling maps to show either **Road View** (roads/geography); **Bird's Eye View** (aerial images); or **Automatic** (best map style when zoomed). Optimization is either by "Speed" or "Speed with Traffic." Real-time updates are available without having to wait for new mapping to be released. Visual mapping is available in many areas. Customer Information displays a map of each job site location; **Route Advisor** determines the best route to place a new customer by displaying nearby customers/days that are routed; and **Service Densities** reveals a visual picture relating to customers/services/routes on a map to assist with building sales density. **866/926-7849; www.routeoptix.com.**

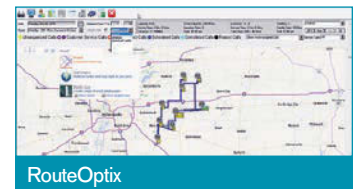

RouteOptix

## GPS

### ASSETWORKS FIELD SERVICE SOLUTION

**AssetWorks Field Service Solution** is a combination of cloud-based software, mobile applications and in-vehicle hardware that improves the efficiency and safety of fleet-based operations. It delivers automatic vehicle location, driver safety, and management of driver behaviors. It combines real-time location tracking, driver behavior dashboard, a comprehensive reporting tool and vehicle history/breadcrumb tracking capabilities. It offers work-order dispatching/field ticketing capabilities where **Android**-based mobile applications provide real-time work dispatch and job status updates while eliminating paperwork and duplicate data entry. With further expansion modules that offer electronic driver logs, vehicle pre/post-trip inspection, lone worker monitoring and APIs for integration with other key business systems at your organization, it provides a single platform for both fleet and work management. **403/705-3880; www.assetworks.com.**



AssetWorks

CONTINUED >>

# 35 YEARS

MULTIPLE INSPECTION SOLUTIONS,  
ONE PROVIDER: RATECH.



Control unit can be mounted to reel.

Elite SD or USB



Mini Crawler with Pan n' Tilt



We also carry



Ultra Micro® Cameras



Pan n' Tilt Push Camera  
(Includes Reel and Remote Control)

Ratech is an industry leader and always at the forefront in the development, manufacturing and servicing of CCTV systems and equipment. From wifi, tablets, iPhone and Android applications to DVD, USB, SD, and more, Ratech offers more flexibility and reliable products than anyone else. So no matter the problem, Ratech has an innovative and groundbreaking solution. And has for over three decades.



# Ratech

ELECTRONICS

Video Pipeline Inspection Systems



For more information on these or other products call toll free:  
1-800-461-9200 or 905-660-7072 [www.ratech-electronics.com](http://www.ratech-electronics.com)

Upload your inspection videos to [YouTube](https://www.youtube.com) Ask us HOW?

### CUES WIRELESS GPS MAPPING STICK

The **Wireless GPS Mapping Stick** from **CUES** works with Granite XP Asset Inspection & Decision Support Software, in conjunction with the Esri Module, to provide locating and positioning solutions. The unit provides the ability to display and record sewer (manhole and lateral assets), storm, fiber and gas pipeline coordinates from a GPS receiver, and transfer this information seamlessly to Granite XP to map the location of these assets. The kit includes a Trimble Pro 6T receiver for a complete turnkey solution. **800/327-7791; www.cuesinc.com.**



### DPL TELEMATICS TRACKALL OBDII

The **Trackall OBDII** from **DPL Telematics** combines compact GPS tracking and integrated OBDII, so management knows not only where vehicles are, but exactly what they are doing and how they are operating. By remotely capturing vehicle OBD activity, they can evaluate real-time and historical operational data to proactively diagnose vehicle issues, efficiently schedule repairs, and pass emission tests. The unit provides real-time visibility into improper or inefficient use of vehicles, as well as safety concerns such as excessive speeding, harsh braking or unnecessary idling. For the vehicle owner, this is a complete telematic solution to increase driver safety and productivity while decreasing the costs and risk of unauthorized asset use. **800/897-8093; www.dpltel.com.**



### FLEETMATICS REVEAL

The **Reveal** GPS vehicle-tracking system from **Fleetmatics** is designed to improve productivity for virtually any mobile workforce. The cloud-based platform includes native apps for iOS and Android, providing visibility of field activity and actionable insight into driver behavior and workforce productivity. **704/716-7646; www.fleetmatics.com.**

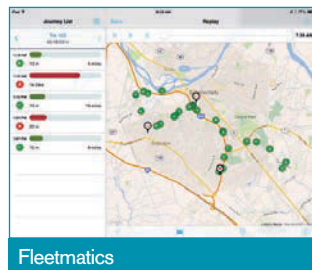

### RIDGID RIDGIDTRAX

**RIDGIDtrax**, a locating app from **RIDGID**, brings maps of a work site's underground utilities to a user's mobile phone or tablet. Using integrated Bluetooth communications, the SR-24 Line Locator pairs with the RIDGIDtrax app to display GPS position and depth of the target utilities. If there are multiple types of utilities, such as water, gas and electric, users are able to identify and display them all within the same map. A finished map can be saved and viewed within the app, or exported to a KMZ file to be used with Google Earth. It is designed for use on the iPhone, iPad or Android, and provides basic utility mapping for mobile devices. **800/769-7743; www.ridgid.com.**

### US FLEET TRACKING AT-V3

The **AT-V3** live vehicle and asset GPS tracker from **US Fleet Tracking** can be used with any Web browser or smartphone, viewing turn-for-turn live movements, allowing the user to verify employee location, confirm service occurred, or optimize the fleet and decrease overhead. It is configurable for five- or 10-second live tracking updates for accurate mileage reporting. Its compact 2 1/2-inch width by 3 1/8-inch length by 7/8-inch height makes it ideal for tight installations. It has a rugged water-resistant IP66 housing and solid-state circuitry. **405/726-9900; www.usfleettracking.com.**

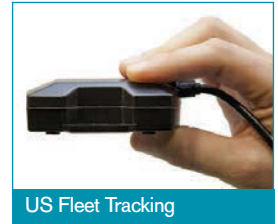

### DISPATCH SYSTEMS

#### CHEVIN FLEET SOLUTIONS FLEETWAVE MOBILE

**FleetWave Mobile** from **Chevin Fleet Solutions** bridges the gap between field workers and the office. It provides a simple-to-use solution for field workers to collect and transfer data to a centralized system or the office quickly and securely with or without an Internet connection. Using almost any hand-held device, it can be tailored to capture, collect and transmit almost any type of data from structured information to signatures and pictures, and will automate and streamline almost any field function, from compliance-related tasks such as vehicle inspections and mileage capture, to process automation including work order creation and service receipts. **781/793-0788; www.chevinfleet.com.**



#### PEDIGREE TECHNOLOGIES ONEVIEW

The **OneView** platform from **Pedigree Technologies** allows management to make real-time changes to routing, update stops, and communicate safely with mobile workers via two-way messaging. The system works with an in-cab work order system, allowing management to dispatch drivers and field service workers in response to the latest job information. Capabilities include worker dispatch, route optimization, turn-by-turn directions, two-way messaging, and vehicle status updates. **800/470-6581; www.pedigreetechnologies.com.**



#### NEXTRAQ FLEET TRACKING SYSTEM

The **NexTraQ Fleet Tracking System** is a cloud-based, comprehensive fleet tracking solution that allows management to easily schedule jobs, dispatch them to vehicles and send messages to and from workers in the field. Included is the NexTraQ Job Schedule Board, which shows all pending jobs and appointments, as well as employees' availability and status of their current jobs. Immediately contact teams in the field to clock work hours, assign jobs, and find the easiest route to



CONTINUED >>

**BIGGER.**

**NEW** Products • **EXCLUSIVE** Giveaways

**BETTER.**

**15% OFF** Cables, Parts, & Accessories

**BOLDER.**

**FREE SHIPPING** on Machine Purchases



**DRAINCABLES**  
*direct*

Can't Make the Show?  
**ORDER TODAY!**  
[draincables.com](http://draincables.com)  
800.421.4580

customers via NexTraq Connect, a downloadable app that makes both office and field employees more efficient in daily business activities. 800/358-6178; [www.nextraq.com](http://www.nextraq.com).

### RITAM TECHNOLOGIES SUMMIT AUTOMATIC DECISION MAPPING AND DISPATCH

The **Summit Automatic Decision Mapping and Dispatch** tool from **Ritam Technologies** provides customer accounting and operations management for near-effortless billing. One click sends service data to the Automatic Decision Mapping, and it balances loads between drivers, considers truck capacity, respects customer time commitments, minimizes overtime, and optimizes routes for most efficient travel. The results are sent to drivers' mobile devices (smartphone, iPhone, tablet, Garmin). Instantly, drivers have their routes with best service sequence, voice navigation, and digital customer signatures or driver confirmation of service completed. In the office, view information instantly, dispatch emergency services, and monitor real-time GPS-type tracking of drivers on street-level maps. No special hardware is required. 800/662-8471; [www.ritam.com](http://www.ritam.com).



Ritam Technologies

### SKYPATROL FLEET COMMAND

**Fleet Command** from **Skypatrol** can help effectively monitor and manage a fleet, easily accessing critical data and performance metrics. Fleet managers can locate all vehicles 24/7 and analyze custom, real-time key performance metrics. With detailed mapping, current vehicle information and tailored reports, it facilitates rapid data analysis that makes way for informed decisions that improve fleet performance and move the bottom line. The platform provides the operator with enhanced monitoring and control over driver activity. 800/369-5007; [www.skypatrol.com](http://www.skypatrol.com).



Skypatrol

### TANK TRACK SOFTWARE

**Tank Track** software is designed to be user-friendly and equip business owners to manage customer information and schedule appointments quickly and easily. Users can customize invoice details, track property information, map truck routes, see when properties are due for service, generate pumping and dumping reports, and print invoices. The online format allows secure access from any Internet location. The program allows users to track multiple service due dates for each property and automatically schedule repeat appointments. 888/704-1335; [www.tank-track.com](http://www.tank-track.com).

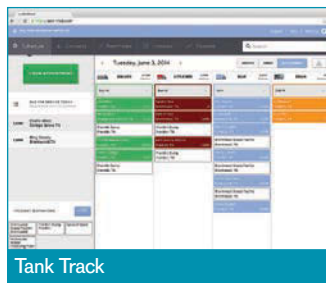

Tank Track

### TENSING USA FMP360

**FMP360** from **Tensing USA** is a standardized mobile workforce management solution that contains all back-office and mid-office connectivity straight out of the box. Within a single app, the configuration of multiple business processes and workflows can be drag-and-drop configured in hours. FMPmaps adds the ability for field workers to have real-time access to back-office GIS information, system of record maps, and asset work history from any modern hand-held device, with or without an Internet connection. A system of record maps can be displayed right on the field worker's smart device, eliminating the need for paper maps or printouts. [www.tensing.com](http://www.tensing.com).

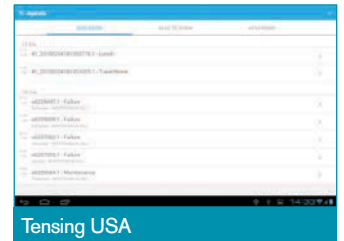

Tensing USA

### VEHICLE TRACKING SOLUTIONS SILENT PASSENGER

**Silent Passenger** fleet management software from **Vehicle Tracking Solutions** is user-friendly and offers a suite of tools that delivers actionable reports by allowing users to view current and/or historical data, as well as receive mobile-friendly alerts (texts, emails) that are easily configurable to a myriad of vehicles. It can significantly increase a company's bottom line by improving safety, minimizing fuel costs, aiding in theft recovery, lowering operational costs, and increasing overall productivity. 631/492-1148; [www.vehicletracking.com](http://www.vehicletracking.com).



Vehicle Tracking Solutions

### WESTROM SOFTWARE THE SERVICE PROGRAM

**The Service Program** from **Westrom Software** is QuickBooks-compatible software that helps schedule work orders and equipment, track and send recurring annual service reminders, and track customer equipment and tank locations. It works on popular iOS and Android devices, providing signature capture and email invoices in the field, and taking pictures after a job is complete. The software is installed on the same computer or network as QuickBooks, allowing databases to sync directly with QuickBooks software. The Mobile Solution option can increase employee productivity. Employees and field techs using the Mobile Solution cannot change or modify QuickBooks because all of the data filters back to The Service Program software. An optional customer portal and custom-branded app increases customer satisfaction and retention. The app is available at both Apple iTunes and Google Play. 866/480-1879; [www.theserviceprogram.com](http://www.theserviceprogram.com). ©

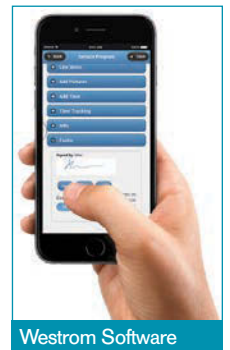

Westrom Software

[www.cleaner.com](http://www.cleaner.com)

classifieds, editor's blog, discussion forums and more!

## IMPORTANT MESSAGE!!!

Some of our competitors are selling very poor quality sewer/drain cameras, which look very similar with Forbest Cameras. Always remember you get what you pay for when you choose price over quality

Compare Forbest Cameras with similar cameras

Features	FORBEST CAMERAS	SIMILAR CAMERAS
<b>Recording</b>	With both USB & SD card	with SD Card only
<b>Operation</b>	Has function buttons on the front panel and has a remote control	Only with remote control
<b>Cable</b>	Strong and solid	Fragile and easily broken
<b>Battery</b>	Safety Test Certificates	No Certificate
<b>512HZ Transmitter</b>	Strong signals and easier to be located	Not easily located
<b>Picture</b>	Very clear - High resolution	Not steady

## WHY BUY FORBEST?

FORBEST has been succeeded for years in providing you the most affordable, trustworthy and high quality Video Inspection Cameras.

**OUR BACKGROUND** – Experienced and Professional with our own manufacture facility with over 25 years of experience in audio; video; camera and other electronic products.

**OUR PRODUCTS** – Patented and High Quality

**OUR PRICE/COST** – Low Cost and Affordable Price. We just seek reasonable profit margin.

**OUR SERVICE** – Low Parts Pricing and Quick Turn-around provided from US & Canada.

### Portable Color Sewer/Drain Camera

**FB-PIC3188/3188D/3188DN**

Specs:

- 65FT/100FT/130FT Cable & Reel
- Color Camera Head
- 7" LCD Monitor w or w/o DVR & MIC
- Aluminium Case or Waterproof Case
- Option 1:** upgrade to Color Camera Head w/Built-in 512HZ Sonde Transmitter
- Option 2:** upgrade to 130FT Cable & Reel w/**Meter Counter (New)**



### Luxury Portable Sewer/Drain Camera

**FB-PIC4188M/4188H**

Specs:

- 130FT Cable & Reel w or w/o Meter Counter
- Color Camera Head w/Built-in 512HZ Sonde Transmitter
- 10" LCD Monitor w/DVR & MIC
- Recording with USB Flash Drive & SD Card
- Heavy Duty Waterproof Case



### Layflat Pipe Inspection Camera

**FB-PIC3588A/3588BT**

- 7"/10" LCD Control Station with Built-in USB Flash and SD Card Recorders and Li-Ion Battery
- 3/8" 150FT /200FT Cable & Reel w/Meter Counter
- 7/8" Stainless Steel Color Camera Head w/ Built-in 512HZ Sonde Transmitter for 3588A (1.5" Stainless Steel Color Camera Head w/Built in 512HZ Sonde Transmitter for 3588BT)



### Mid-Range Pipe Inspection Camera

**FB-PIC3388M/3388MT**

Specs:

- 200FT Cable & Reel w/ Meter Counter
- Self Leveling Camera Head w/ or w/o Built-in 512HZ Sonde Transmitter
- 10" LCD Monitor w/DVR & MIC
- Heavy Duty Waterproof Case



### Long Range Pipe Inspection Camera

**FB-PIC3288T/3488T**

Specs:

- 300FT/400FT Cable & Reel w/Meter Counter
- Self Leveling Camera Head w/Built-in 512HZ Sonde Transmitter
- 10" LCD Monitor w/ DVR & MIC
- Heavy Duty Waterproof Case



### Pan-Tilt 360°/180° Camera System

**FB-PIC3688C**

Specs:

- 400FT Cable & Reel w/Meter Counter
- Pan-Tilt 360°/180° Color Waterproof Camera Head w/Manual Zooming
- 7"/10" LCD Monitor w/DVR & MIC.
- Recording with USB Flash Drive & SD Card
- Crawler for easier push



### Economic Full Function Inspection System

Specs:

- 7" LCD monitor with built-in SD Card recorder
- CMOS color camera with built-in 512HZ sonde transmitter for option
- 65FT/100FT/130FT cable for option



### Multi-Function Control Station

Specs:

- Compatible with all Forbest systems
- Recording with both USB memory and SD Card
- integrated text writing and Pan-Tile Camera control functions



### Mini- Self-Leveling Camera Head

Specs:

- 26mm / 1" in diameter, 75mm / 3" long
- Built-in 512 HZ Sonde Transmitter for option
- Compatible with all Forbest systems



### Wireless Digital Sonde Locator

Specs:

- Working frequency : 512HZ
- Output Intensity : LCD / 15 Levels
- Retractable pole



Please go to our website [www.forbestusa.net](http://www.forbestusa.net) for more info.



**ANNOVI  
REVERBERI**  
High Performance Pumps

## Jetter and Washdown Pumps



RTP 7.9-10 GPM @ 7250 - 8700  
RTF 36-40 GPM @ 1500  
RTJ 18.5 GPM @ 4000

Professional Strength  
Specialty Pumps

*"The First Choice When  
Quality Matters"*



RTX Pumps  
Model #'s 30-50-70-85-100  
7.9 - 26.4 GPM  
1450 - 4350 PSI

AR North America  
[www.arnorthamerica.com](http://www.arnorthamerica.com)  
[info@arnorthamerica.com](mailto:info@arnorthamerica.com)  
(763) 398-2008



## Rotary Vane Vacuum Pumps

Since 1952

- Septic Tanks and Slurry
- Sewage Pipes
- Sanitary
- Oil Field Industries
- Milk and Water Tankers
- Agricultural



MEC II 13500



WPT 720

For More Information, Contact  
[info@bppna.com](mailto:info@bppna.com)



**Battioni®  
Pagani  
Pompe**

**Power**  
at your service

## CASE STUDY

# Field and Office Technology

By Craig Mandli

## MOBILE AND WEB TECHNOLOGIES CREATE EFFICIENCIES FOR GREASE BUSINESS

### PROBLEM

All American Grease Services of New Orleans crafted plans for substantial growth. The company's controller, Bobbie Breaux, knew that operational inefficiencies would pose challenges.



### SOLUTION

Breaux was referred to **Web App Express**, which delivered a comprehensive Web and mobile software system that takes care of every aspect of the company's operations, including scheduling drivers' work and routes, and report writing. Manual processes and paper have been almost completely eliminated, and drivers are more productive. "In the past we printed out tickets for drivers. Today they use an intuitive mobile app," says Breaux. "Drivers worried about moving to the new system, but the app is so easy to use and saves so much time that now you can't get it away from them. Before they were inundated with paper, but now they just use a tablet."

### RESULT

Customers are happier. They get invoices quicker and that are more accurate. The system has increased customer loyalty and made it easier to attract new clients. The system even allows customers to remotely view service and scheduling-related data, as desired. "It's a big winner for us," says Breaux. "Processes that took days are now done in minutes and integrated with our accounting software, making it seamless." When All American initially partnered with Web App Express, its primary service area was New Orleans. Today it provides services across nine states. 800/699-4840; [www.webappexpress.com](http://www.webappexpress.com). c



GET  
**EMAIL NEWS  
ALERTS** FOR  
**Cleaner**

Go to [cleaner.com/alerts](http://cleaner.com/alerts) and get started today!



# USJETTING®

## 4018

4000 PSI 18 GPM  
**INDUSTRY LEADER**  
CLEANS 1 - 24 INCH LINES



# RELIABILITY.

ENGINEERING. QUALITY. PERFORMANCE. INNOVATION. DURABILITY. SIMPLICITY.

  
**wwett**  
2016

**COME SEE US AT THE SHOW!**  
INDIANA CONVENTION CENTER BOOTH 5334 & 5335  
FEBRUARY 17TH - 20TH 2016

WWW.USJETTING.COM | 1-800-538-8464 | SALES@USJETTING.COM



# Quality Used Trucks

## Available for Immediate Delivery



**2015 Predator LVT**  
Truck ID #E0223

- Cummins 350HP
- RCF500 Rotary Vane Pump - 350 CFM
- Hyd. dump body
- 4" pressure and vac piping
- Primary & secondary shutoff
- 4" inlet, self closing Betts valve
- 6" discharge, self closing Betts valve
- Liquid level indicator
- Isolation valve
- 50 gallon hyd. tank



**2009 Mack GU173 with 2009 Vactor 2115**  
Truck ID #06684

- Mack engine with 365 horsepower
- Eaton Fuller RTO-14908LL transmission
- Mileage: 3,600
- Roots 824 blower 16" vacuum
- 80 GPM @ 2500 PSI Vactor Rodder Pump
- 1500 gallon water tank
- 8' telescoping boom with work lights
- Telescoping/rotating hose reel w/ 500' rodder hose
- Fold-down pipe racks



**2005 International 5600I with 2013 Guzzler CL | Truck ID #50572**

- ISM 320V engine has been rebuilt
- 385 horsepower
- Eaton Fuller transmission
- 49,390 miles with 5,064 engine hours
- GVWR: 66,000
- 18 yard payload capacity
- 5300 CFM 28" vacuum blower

©2015 FS Solutions Group

Interested? Call John Stafford, FS Solutions Used Equipment Sales Manager (815) 341-3512 for pricing or visit [fssolutionsgroup.com](http://fssolutionsgroup.com) for a complete listing of used equipment



## CUSTOM DRILLED NOZZLES

### SIX PACK KIT™



**NOW OFFERING JETTING HOSE!**  
CALL FOR A QUOTE

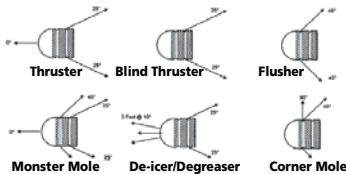

NPT Size	Price	Savings*
1/8"	\$224	\$37
1/4"	\$254	\$44
3/8"	\$294	\$52
1/2"	\$373	\$67

\*Compared to individual prices

- Each nozzle is **custom drilled** to match your pump's flow and pressure specs for **optimized nozzle performance**.
- Custom drilling means **your choice of spray patterns**.
- Each nozzle is made with **heat treated 416 stainless steel** for superior corrosion and wear resistance, and rated up to 10,000 psi.
- Most orders shipped within **one business day**.
- **100% satisfaction guarantee**.



**CALL TOLL FREE: 877-457-2782**

North Royalton, OH 44133 • [www.aquamole.com](http://www.aquamole.com) • Fax: 440-237-2987

## Petersen® Pipe Plugging Systems



Pipe Plugs and Packers for all your Pressure, Chemical, and Temperature Requirements. Call us to quickly customize a pipe plug or plugging system for your specific application.



### Economical Hot Tap Plugging Systems

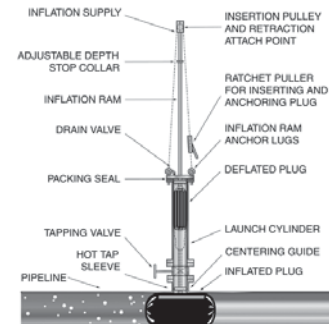

[www.pipeplug.com](http://www.pipeplug.com)

**Petersen PRODUCTS COMPANY**  
Serving Professionals Since 1916

PHONE 800.769.4973 OR 262.692.2416  
FAX 800.669.1434 OR 262.692.2418

# ALLAN J. COLEMAN

SINCE 1905

Call us today!  
773-728-2400

5725 North Ravenswood Avenue • Chicago, IL 60660 • info@allanjcoleman.com • www.allanjcoleman.com



## OLDEST NAME IN THE BUSINESS — Over 100 YEARS OLD

### CS65 Digital Reporting Monitor

- One touch recording
- 1 TB internal hard drive
- 6.5" Daylight viewable LCD display
- Water-resistant keyboard
- SeeSnake HQ Software



### SeeSnake® CS6 Digital Recording Monitor

- Direct-to-USB recording for fast, efficient documentation of inspection jobs
- Water-resistant keypad for direct control of essential camera and monitor functions
- Daylight viewable display for a crisp, clear in-pipe image
- SeeSnake HQ Software to edit, archive, and deliver reports via print, DVD, or online
- On-screen keyboard for basic titling and text entry
- CS6 will dock in the RM-200 Max or operate as a stand alone monitor



# RIDGID®

### SeeSnake® MAX rM200 Camera System

- Next Generation Push Cable and Improved Reel Mechanics
- Ultra Compact Camera Head
- Transport Enhancements
- Docking System • Self-Leveling Camera Head



### SeeSnake® Mini Camera Reel

- 1 1/2" to 6" Lines up to 200'
- New Self-Leveling Camera Head
- Built-In 512 Hz Sonde
- Metal Frame and Rugged Drum



### SR-24 Line Locator with Bluetooth® and GPS

- Omnidirectional antennas
- Large display • Built-In GPS
- Bluetooth® technology
- Smartphone/Tablet App
- Can trace any frequency from 10 Hz to 35,000 Hz



### MR-10 Magnetic Locator

- Quickly locate buried iron or steel objects
- Ergonomic rugged design includes carrying case and batteries
- Highly sensitive instrument with audio and visual feedback
- AutoNull feature blocks out nearby metallic interference such as an automobile



### SeekTech® SR-20

SeekTech uses omni-directional antennas, guidance arrows and an easy to read mapping display.



### NaviTrack® Scout®

Scout is designed to solve demanding remote transmitter (sonde) locates using multi-directional locating technology.

**Authorized SeeSnake Repair Center**

**THE BEST SERVICE AND FAST TURN AROUND!**

**We Have RIDGID Parts!**

**If you buy the best, you are only sorry once!**

PRODUCT SPOTLIGHT

**HammerHead Sidewalker redesign adds convenience, power and speed**

By Luke LeNoble



The Sidewalker piercing tool from HammerHead Trenchless Equipment is designed for installing short utility runs beneath landscaping, driveways and sidewalks.

Upgrades to the 2 1/2- and 3-inch models have increased efficiencies in design and pneumatics, including the quarter-turn Power Port Reverse feature that boosts impact power by up to 25 percent. The 3-inch Sidewalker has a uniform profile along its entire length, increasing striker size.

“The models that these tools replace in our previous fleet are tools that were ‘bulbed,’” Josh Hood, product manager for HammerHead, says. “This means that the previous tools were small tools with a larger-diameter bulb on the backside of the tool. A new 3-inch Sidewalker tool has the power of a 3-inch tool versus the power of a 2 1/2-inch tool with a bulb.”

The tools are designed for contractors who typically do short shots, such as small irrigation or water services with minimal pit dimensions. They have traditionally been used to install 3- to 20-foot underground runs of gas, water and other utility lines in tight urban areas.

Since the tools’ body lengths are just under 34 and 42 inches, they require much smaller working pits than standard-length piercing tools.

“Because of the significant reduction in length, it makes it a great tool for driveway and sidewalk crossings as the pit required to launch the tool can be reduced by as much as 30 percent,” says Hood. “The longer a tool is, the more accurate the shot will be as there is more surface area that maintains the path, hence the fact these tools are for short shots.”

Shorter tools tend to have less overall power than longer tools as the stroke of the internal piston is shorter and has less mass, Hood says. The Sidewalker overcomes that issue by increasing the strokes per minute by as much as 40 percent.

The piercing tools, which operate at 110 psi, include the Debris Free Tailcone, decreasing the amount of foreign matter entering the tool body, increasing overall production and extending the life of the tool.

As with all HammerHead models, a clamped rear anvil provides 200 percent more clamp load than other designs, yet makes the tools easy to maintain. 800/331-6653; [www.hammerheadtrenchless.com](http://www.hammerheadtrenchless.com).



1



2



3

**1 MR. MANHOLE MANHOLE CUTTER**

The Gold Series Six Shooter from Mr. Manhole is an upgrade to the company’s premier manhole cutter, which features enhanced power, speed and durability. Attached to a skid-steer, the manhole cutter also features improved cutting surfaces, a heavier frame, Quick Adjust variable cutting diameter that ranges from 28 inches to 72 inches, and custom heavy-duty auger drive. A minimum flow of 30 gpm and 2,500-pound minimum lifting capacity is required. 419/741-9075; [www.mrmanhole.com](http://www.mrmanhole.com)

**2 HILTI MODULE DIAMOND CORE BITS**

The X-Change module (X-CM) core bits by Hilti can be re-tipped on the job site in just a few minutes using a screwdriver, allowing operators to replace a worn X-CM module with a new module instead of replacing the

entire core bit in the event a bit becomes stuck in concrete. All modules are easier to store and transport than complete drill bits, and are available in diameters ranging from 2 to 8 inches. 800/879-8000; [www.us.hilti.com](http://www.us.hilti.com).

**3 COXREELS EZ-COIL SAFETY SYSTEM**

The EZ-Coil safety system from COXREELS was developed exclusively for spring-retractable lines and retracts up to 80 percent slower than conventional reels. It works unidirectionally without any increase to the amount of resistance when pulling out the hose, cord or cable. When engaged upon recoil, this safety system controls the aggressive spring motor energy resulting in a reel that retracts at a safe and steady pace, enhancing operator safety. 800/269-7335; [www.coxreels.com](http://www.coxreels.com).

CONTINUED >>

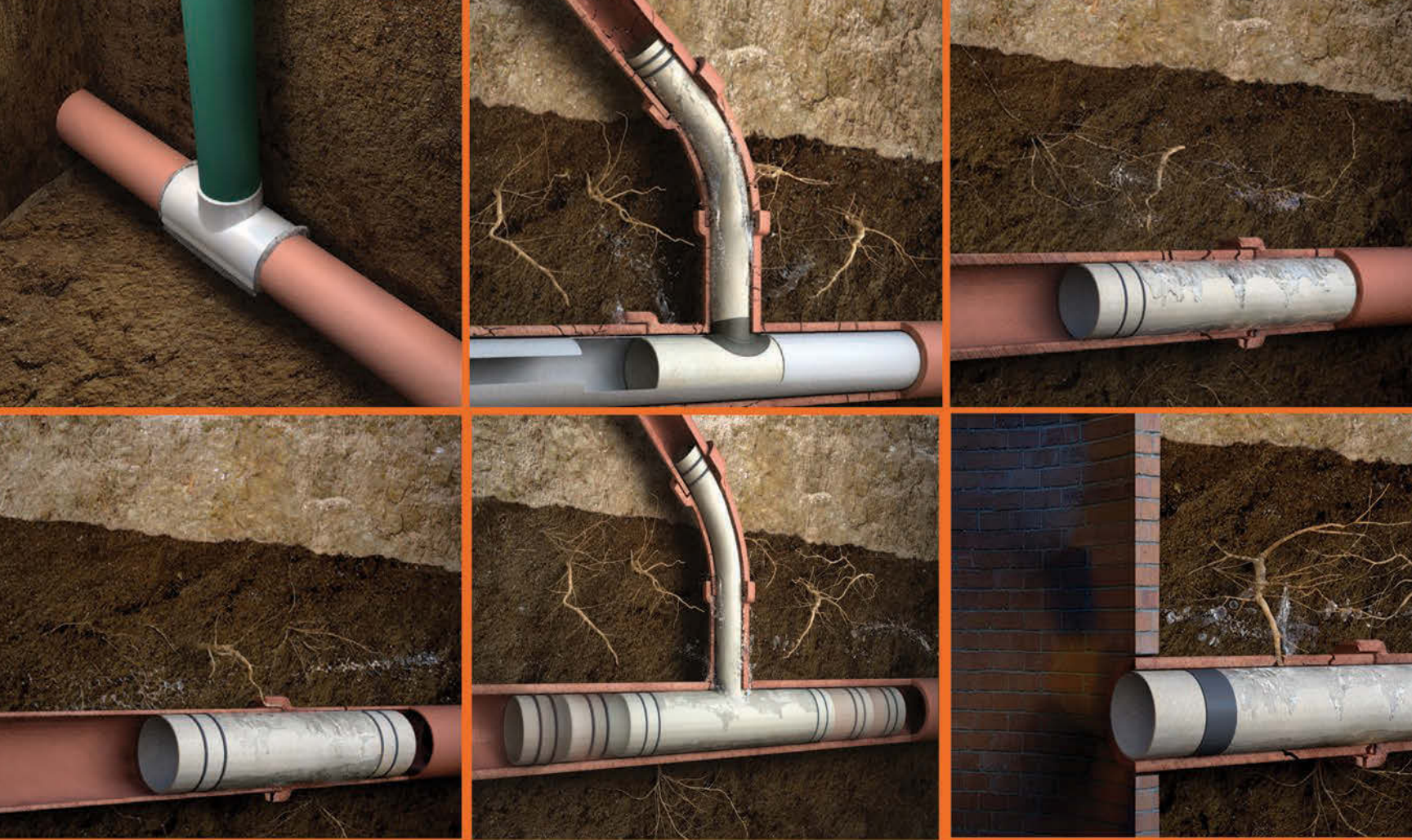

# INSTALLERS WANTED

## Cleanout System

- ASTM F3097 Compliant
- VAC-A-TEE® Saddle Kits
- Minimally Invasive Installation
- Easy to Install

## Mainline Repair

- ASTM F2599 Compliant
- Inverted In-Place Sectional CIPP Lining

## Main to Lateral Lining

- ASTM F2561 Compliant
- T-Liner®, Shorty™, and Stubby™ One-Piece Connection Lining Systems
- Insignia™ Compression Gaskets

## Introducing Sectional T-Liner

- Simultaneously repair a section of the mainline and the lateral service line

## CIPP Lateral Lining

- 100% Trenchless
- Performance Liner® CIPP Lining
- Lining Through A Cleanout

## Gasket Sealing

- Insignia End Seals
- 6 in. - 54 in. Diameters Available



Visit us at WWETT-LIVE DEMOS



MAINLINES | LATERALS | MANHOLES | GASKET SEALS | EQUIPMENT

Phone: (815) 433-1275 Email: [info@lmktechnologies.com](mailto:info@lmktechnologies.com) Web: [lmktechnologies.com](http://lmktechnologies.com)



4

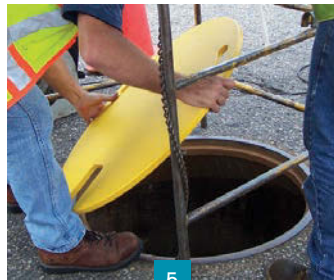

5



6



7

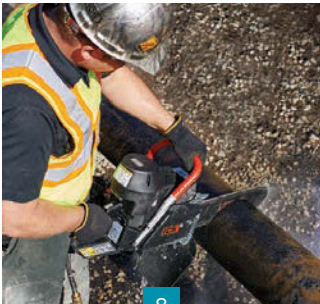

8



9



10



11

#### 4 WATER CANNON JETTER TRAILER

The 16T52, two-wheel commercial jetter trailer from Water Cannon has 500-foot by 3/8-inch hose reel capacity, 200-gallon water tank with float valve, polyurethane toolbox, lights, front jack with wheel, safety chains, and aluminum fenders. The commercial high-pressure jetter has a Vanguard 18 hp electric-start engine with 15-gallon fuel tank, TS Series General triplex plunger pump (5.5 gpm, 3,500 psi), 8-foot jumper hoses, and three jetter nozzles (penetrator, flusher and degreaser/deicer). **800/333-9274; [www.watercannon.com](http://www.watercannon.com).**

#### 5 U-TECK TEMPORARY MANHOLE COVERS

Safe-T Lid temporary covers from U-TECK provide fall-in protection while the manhole or hand-hole lid is removed. Made from high-impact-resistant composite, the lids support 400 pounds of direct weight. Openings along the edge accommodate cables, ducts or hoses. Hand openings allow for easy transport, placement and removal. **800/542-7011; [www.uteck.com](http://www.uteck.com).**

#### 6 ELECTRIC EEL PIPELINE INSPECTION CAMERA

The ACE 2 pipeline inspection camera system from Electric Eel Mfg. Co. features one-touch USB recording, on-screen footage counter, wheel kit for easy transport, and heavy-duty screen cover. The inspection system has a stainless-steel-housed 1.68-inch-diameter color camera with sapphire lens, 20 LED light ring and high-resolution CCD element (optional self-leveling color camera), 200 feet of Kevlar braided 1/2-inch-diameter pushrod, 512 Hz sonde, and 5.4-inch LCD monitor with AR film for optimal viewing in sunlight. **800/833-1212; [www.electriceel.com](http://www.electriceel.com).**

#### 7 GOULDS END SUCTION CENTRIFUGAL PUMP

The 316L stainless steel end suction centrifugal pump from Goulds Water Technology - a xylem brand is designed for water circulation, booster service, spray system, washing/cleaning system, air scrubbers and general water services. The pumps can be mounted horizontally or vertically. The standard

NEMA single- or three-phase motors are made for continuous duty under all conditions. **866/325-4210; [www.goulds.com](http://www.goulds.com).**

#### 8 ICS PIPE CUTTER

The 680PG-10 PowerGrit Utility Saw from ICS, a Blount International Brand, is a pipe cutter designed to cut plastic pipe to ductile iron pipe up to 10 inches in diameter. The new 680ES engine platform features a 76.5 cc, 5 hp engine and a direct-drive clutch, so the drive belt doesn't slip in wet conditions, unlike most circular cut-off saws. **800/321-1240; [www.icsdiamondtools.com](http://www.icsdiamondtools.com).**

#### 9 BAYCO LED WORK LIGHTS

The SL-1500 Series LED work lights from Bayco Products are constructed with a rear multi-fin heat sink that keeps the fixtures cool to the touch. Each single fixture work light produces 2,200 lumens of light. The SL-1522 has dual light fixtures for a combined output of 4,400 lumens. Fixtures can be tilted or swiveled independently allowing the user to position the fixture where light is needed. **800/233-2155; [www.baycoproducts.com](http://www.baycoproducts.com).**

#### 10 OPTRONICS MINIATURE LED WORK LAMPS

The Opti-Brite TLL30FB Series of miniature LED work lamps by Optronics International measure 3 1/4 inches in diameter with the capacity to produce a raw lumen output of 960. It can be mounted on any vehicle with 4 1/2 inches of clearance and comes stocked with a stainless steel mounting bracket. The lamp is designed to accommodate both 12- and 24-volt systems. A lifetime warranty replaces the lamp even if one diode fails. **800/364-5483; [www.optronics.com](http://www.optronics.com).**

#### 11 DITCH WITCH MINI SKID-STEER

The SK752 from Ditch Witch, a Charles Machine Works Company, is a new, construction-grade mini skid-steer that features a 24.8 hp Kubota diesel engine. The machine has an 860-pound operating capacity and

CONTINUED >>

# NEW LISY 3.2

Introducing the new LISY 3.2 Lateral Launch System by IBAK. The LISY 3.2 is the latest evolution in the industry's most advanced lateral launching system. Trusted by most major contractors and large cities throughout the world, the LISY has always provided you with superior production capabilities.

The front articulation arm of the LISY 3.2 has been redesigned for greater strength and lower weight. The geometry of the front end has been altered to avoid debris and water retention during operations. Cable routing has been improved to protect critical cables. The entire drive system was revamped with a larger drive motor and more efficient pressure wheels to increase the launch speed by up to **4 times faster** than other lateral launchers!

With faster launch speeds, shorter more flexible front connector options, and smaller launch cameras, the LISY 3.2 is perfect for your more demanding projects, including reverse-launches.

The new LISY 3.2 was designed to work with the new **3-D GeoSense® system** from IBAK. This revolutionary system from IBAK gives you the power to map lateral pipelines with accuracy and speed. The new 3-D GeoSense® sensor tracks the movement of the camera as it travels through the lateral, capturing distance, position and depth in three dimensional space. This data is captured and displayed by your data logging software. **Finally, there is no more guessing. You no longer have to track the system above ground with a locator, simply conduct your inspection and collect the positional data. This is the perfect system for cross-bore analysis!**



Currently integrated with WinCan Vx. Other integrations in preparation.



# NEW TECH ON DISPLAY AT WWETT BOOTH #2207



INTRODUCING

# NANO

## Small Diameter - Huge Features

While the NANO® is capable of traveling in pipelines as small as 2" in diameter, you will not be giving up power or flexibility. The NANO® has many of the same features of the larger ORION Zoom including: laser measurement, integrated location transmitter, bright LED lights, pressure regulation and full pan and tilt functionality!

## Pushrod, Tractor or Lateral Launch CAPABLE!

Camera Dimensions	
Length	84mm / 3.30"
Diameter	47mm / 1.85"

Technical Specifications	
Pan Range	+/- 120°
Angle of View	+/- 150°
Rotation	Continuous
Pressure Protection	Standard
Operating Range	2" and up
Upright Picture	Automatic
Lateral Launch Capability	Yes
Pushrod Deployment	Yes
Tractor Deployment	Yes
Laser Measurement	Diameter, Deflection, Defect
Location Transmitter	33 kHz



(800)-656-4225 | [www.rapidview.com](http://www.rapidview.com) | Past Proven. Future Ready.



12



13



14



15



16



17



18

increased hinge-pin height to 83 inches for more efficient loading. It features an ergonomic operator's station with standard dual-lever ground drive controls, an operational joystick and two-way auxiliary foot pedal. The platform measures 74 square inches. **800/654-6481; [www.ditchwitch.com](http://www.ditchwitch.com).**

## 12 HACKNEY VAN SHELVING

Hackney is releasing both aluminum and steel shelving lines beginning with the Ford Transit, targeting contractor service markets with an emphasis on simplifying the buying process. Aluminum shelving is lightweight with adjustable shelves designed to hold Hackney's storage trays or tools. The Inventory Management Shelving (IMS) system is a heavy-duty steel shelving solution that offers both driver- and passenger-side packages, or as a complete package with top-shelf storage for ladders and pipe. **252/946-6521; [www.hackneyservice.com](http://www.hackneyservice.com).**

## 13 HOT JET USA TRAILER-MOUNTED JETTER

The HotJet III from Hot Jet USA is a trailer-mounted water jetter with two 35 hp Vanguard engines, featuring 20 gpm of hot or cold water at 3,850 psi. It is designed to clean lines from 2 to 24 inches with the proper nozzles and features a wireless remote control with a range of up to 300 feet, and includes 500 feet of 1/2-inch hose, 300 feet of 3/8-inch hose and 100 feet of sanitary hose; 1/4-inch line is also included for laterals. Included is the choice of a 300- or 660-gallon water tank and a 5-foot by 14-foot tandem-axle diamond plate trailer. **800/624-8186; [www.hotjetusa.com](http://www.hotjetusa.com).**

## 14 PERMA-LINER LATERAL CONNECTION SOLUTION

InnerSeal is an engineered solution from Perma-Liner Industries for repairing defective laterals and the connection to the mainline. It is a one-piece, structural and continuous main-to-lateral CIPP that completely seals the connection while simultaneously renewing the lateral. It was designed using the standard practice for the rehabilitation of sewer service laterals — ASTM F2561-11. **866/336-2568; [www.perma-liner.com](http://www.perma-liner.com).**

## 15 TECHSPRAY CLEANING SOLVENT

PWR-4 Maintenance Cleaner from Techspray is a cleaning solvent engineered to be a safer alternative to common industrial solvents

like n-propylbromide. It quickly dissolves oils, greases, fluxes, silicones, dirt and grime. Fast evaporation and high-dielectric strength allows work to be completed quickly. The solvent is designed for wiping down ultrasonic cleaning equipment and vapor-degreaser equipment, and comes in 1-gallon, 5-gallon or 55-gallon drums. **800/858-4043; [www.techspray.com](http://www.techspray.com).**

## 16 CHEMTRONICS CLEANING SOLVENTS

Delta Precision Solvents from Chemtronics are nonflammable cleaning solvents designed to replace AK225 and other engineered cleaning solutions. Flux-Off Delta Flux Remover removes encrusted and oxidized flux deposits. Electro-Wash Delta Cleaner Degreaser removes all contaminants with solvency for heavily oxidized hydrocarbon or silicone grease and oil residues. Pow-R-Wash Delta Electronics Contact Cleaner is designed for electrical and electronic components and assemblies. Choose from aerosol packaging or bulk liquid in 1-gallon, 5-gallon or 55-gallon drum packaging for cold cleaning and ultrasonic cleaning. **800/645-5244; [www.chemtronics.com](http://www.chemtronics.com).**

## 17 ALLIED EQUIPMENT & RENTALS SAFETY SCREEN

The Stump'R Guard from Allied Equipment & Rentals is a safety screen for the hydroexcavation industry. Each screen is 5 feet high and expands to 12 feet wide. Made out of construction-grade, vinyl-coated mesh, it is rated at 200 psi burst strength. It weighs less than 16 pounds and collapses to 8 inches in diameter for easy storage. Install with five steel stakes into the ground or optional bases available for use on hard surfaces. It is available in orange or galactic green. **414/322-4973; [www.alliedequipmentrental.com](http://www.alliedequipmentrental.com).**

## 18 INFRASTRUCTURE REPAIR SYSTEMS ELBOW SPOT REPAIR SYSTEM

The Trenchless 90-Degree Elbow Spot Repair System from Infrastructure Repair Systems is an elbow spot repair system to seal joints, cracks or missing sections within the 90-degree curve of any 4- to 6-inch pipe. **877/327-4216; [www.irsi.net](http://www.irsi.net). c**





**FEBRUARY 18, 2016**

**10:00 AM BOOTH #3127**



WHY DO LESS WHEN YOU CAN **ACHIEVE** SO MUCH MORE?

**Picote Coating System** A simple way to renew small diameter drains

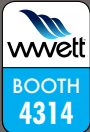
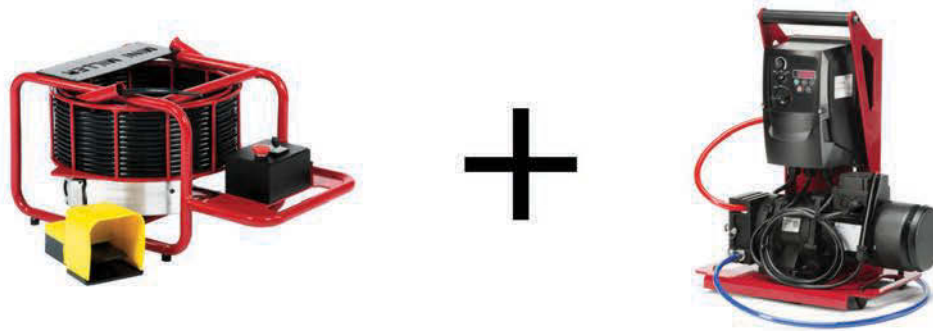

Locate your reseller at [picotesolutions.com](http://picotesolutions.com) or call **219 440 1404** for further information.

**NEW:** Picote Worldwide Training Center now open in Anderson, SC.

THE SMART CUTTER™



PRODUCT OF THE YEAR 2012

**This Is The Nozzle You've Been Waiting For**

\*Patented

**Root Rat**  **root cutter nozzle**

**1/2"**  
7-35 gpm/1500-10,000 psi

**3/8"**  
3-10 gpm/2000-7500 psi

**3/4-1"**  
40-160 gpm/1500-4000 psi

**Custom Built Jetters**  
Hot or cold water jetters from 4 gpm at 4000 psi to 12 gpm at 4000 psi, skid or cart frames or small trailer systems.

**Root Rat Combo Kit**  
3/4" - 1" root rat combo kit. Use a reducer adapter to go from 1" to 3/4".

*"The Root Rat is the easiest and most versatile root cutter nozzle I have ever used. The Root Rat works where other nozzles fail."  
Tim Jones, owner of Eastern Sewer Jetting*

**MADE IN THE USA**



**WE SELL AND SERVICE COLD WATER JETTERS**

We Sell Parts, Pumps, Unloaders, Hoses, Jet Tips, ETC.

Visa, Mastercard, Discover, AmEx Accepted

**CHEMPURE PRODUCTS CORP.**  
1-800-288-7873 • 330.874.4300

[www.rootrat.net](http://www.rootrat.net)

# LAPLACE EQUIPMENT

RENTALS, SALES & SERVICE

**• WATERBLASTERS:**

- PRESSURE TO 40K, FLOW TO 100 GPM
- WATER JETTING TOOLS
- HYDRO-MOWERS
- 3D NOZZLES
- ROTATING NOZZLES
- HIGH PRESSURE HOSES
- LANCES
- FITTINGS
- TIPS
- SUPPLIES
- EXPERIENCED TEAM FOR PLANNING, TRAINING & SETUP

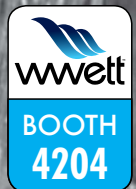

**CALL 985.652.5210 FOR YOUR WATERBLAST PROJECT SOLUTIONS**  
[WWW.H2OBLAST.COM](http://WWW.H2OBLAST.COM)

# PIPE BURSTING PROS DEPEND ON HAMMERHEAD®

“ We worked very closely with HammerHead Trenchless Equipment in the development of their new 100XT static pipe bursting system, and we couldn't be happier with the final result. It's fast, reliable, and backed by customer support that has always been quick to respond when we have a question. Municipalities are catching on to the advantages of pipe bursting, and our 100XT positions us to take advantage of pipe bursting's growing popularity.”

**MARK DIMICHELE,**  
Owner, D & D Water & Sewer, Canton MI



**EQUIPMENT.  
EXPERTISE.  
SUPPORT.**

HammerHead Equipment products and expertise take the guesswork out of pipe bursting. And legendary factory support puts even the toughest pipe bursting jobs within your reach.



Find your local dealer at  
[hammerheadtrenchless.com](http://hammerheadtrenchless.com)  
or call 800-331-6653



**MOLING | RAMMING | BURSTING | HDD ASSIST | WINCHES | CIPP**

**Visit us at WWETT, Booth # 5200!**



**Quam Construction joins list of LMK licensed contractors**

Quam Construction, based in Willmar, Minnesota, has joined LMK Technologies' network of independent licensed contractors for the T-Liner Main-to-Lateral Connection Lining System. As part of its underground utilities division that services municipal, commercial and residential areas, Quam has announced plans to become licensed in LMK's Performance Liner Sectional Spot Repair, cured-in-place manhole rehabilitation, and VAC-A-TEE clean-out systems.

**Researcher receives ADS achievement award**

Rafael Munoz-Carpena of the University of Florida-Gainesville received the American Society of Agricultural and Biological Engineers (ASABE) 2015 Advanced Drainage Systems Soil and Water Engineering Award. The ADS-sponsored award recognizes Munoz-Carpena for his research, methodology and educational contributions in the development and advancement of integrated hydrologic and water-quality modeling.

**Grundfos holds annual Walk for Water event**

About 175 Grundfos Pumps employees joined family, friends and corporate partners for their annual Walk for Water event held in Kansas City, Missouri, and Aurora, Illinois. The initiative was designed to raise awareness about the global water crises and to raise funds for safe, sustainable water solutions in developing countries. Grundfos first held the event in 2012 and to date has raised more than \$200,000 for Water Missions International.



**Cloverleaf Tool Co. purchases Jetter Parts Depot**

Cloverleaf Tool Co., which is based in Sarasota, Florida, and manufactures and distributes pipeline and sewer cleaning and maintenance equipment for jetters and jet/vacs, has purchased Jetter Parts Depot of Orlando, Florida.

**Allstate Power-Vac announces new equity investor**

Allstate Power-Vac announced Nov. 2 that the company has finalized a strategic partnership with Kinderhook Industries and its affiliates. As a result of the partnership, Kinderhook, a private equity firm based in New York, has completed a significant equity investment in APV. The partnership will provide APV with access to new capital.

**RapidView names new training and installation expert**

RapidView IBAK North America has announced the appointment of Richie Notz as the company's new training and installation expert. Notz, who has years of experience in pipeline inspection and training, was previously a field supervisor for a pipeline inspection company.



Richie Notz

**McElroy adds new distributor in Louisiana**

McElroy Manufacturing has announced the addition of a new distributor, Industrial Municipal Supply Co. of Geismar, Louisiana, to service pipe fusion machine customers throughout the state. IMSCO has 40 years of experience in custom fusion service, on-site fabrication and maintenance on McElroy machines in addition to being a supplier of HDPE pipe, valves and fittings.

**Vanair announces expansion**

Vanair Manufacturing announced the acquisition of an 80,000-square-foot manufacturing facility in Michigan City, Indiana, to accommodate increased growth and future expansion. The acquisition brings the company's total production and office space to over 160,000 square feet. The new space will provide capacity for increased manufacturing, training, support, service and leadership functions across the company.

**WSSC approves infrastructure repair solutions from LMK Technologies**

The Washington Suburban Sanitary Commission, one of the largest water and wastewater utilities in the United States, has approved two infrastructure repair solutions from LMK Technologies — the Insignia End Seal Sleeve and the LMT (Lined Main Tap) Saddle — for use in sewer systems in Maryland's Montgomery and Prince George's counties.

**Vermeer names Andringa president, CEO**

Jason Andringa assumed the role of president and CEO at Vermeer effective Nov. 1. The announcement was first made in August as part of the company's family-succession planning process. Andringa previously served as president and COO, in addition to a number of other roles since joining the company in 2005.



Jason Andringa

**Continental reaches 1 million retreads milestone, partners with CMC Tire**

Continental Tire North America set a new record of 1 million retreads on Oct. 29 at its ContiLifeCycle facility located in Morelia, Mexico. The company also announced a partnership with CMC Tire to expand its retreading network, including the opening of its first commercial tire retread facility in Las Vegas. The new retread facility can produce up to 24,000 retreads annually with the capacity to grow to 48,000.

**Hanson Building Products announces company name change**

Hanson Building Products has changed its name to Forterra following the recent sale of the company. The company will continue to operate its five U.S. and Canadian divisions as well as its building products division in the United Kingdom. Plans are to continue production of all existing product lines through its more than 130 facilities.

CONTINUED >>

# The Contractor's Package



**The Upright Electric Package**



**The Jetter Package**



**The Video Inspect/Locate and Leak Detect Package**

## Everything you need— one package.

Includes our Upright Electric, Jetter, and Video Inspect/Locate/Leak Detect packages shown. A full line of tools and machines—so you can do your best work.

- **M888** (for 3-10" lines) and **M661** (for 1¼" - 3" lines) cable machines
- **M30** (mainline) and **M20** (sinkline) jetters
- **NGX10** (for 3 - 8" lines) and **MSA-NG-PCAM** (for 1½" - 3" lines) Next Generation cameras
- And much more!



MyTana is your ONE Source for all the tools the sewer and drain cleaning professional needs. And personal customer service to help you—in the shop or in the field.



**1.800.328.8170**  
**www.MyTana.com**

 Made in the U.S.A.

Request your **FREE**,  
**FULL LINE** catalog today!  
**1.800.328.8170**



CABLE MACHINES – JETTERS – PUSH CAMERAS FOR MAIN LINES AND DRAIN LINES • LOCATORS • RELATED PARTS • ACCESSORIES  
Factory Direct Customer Service Competent • Polite • Clear (M–F 7am - 5pm CST)

**ultra ultra ultra**  
**LIGHT – VERSATILE – SAFE**

# ultraSHORE

PRODUCTS



**Quick to Install.**  
 As light as 130lbs.



**Roll Your Own.**  
 Optional wheel kit.



**Stacks easily with**  
 2' & 4' high panels.

**This is What Aluminum Shoring Was Meant to be!**



1-800-683-8837

**1-800-SHORING**

CALL TOLL-FREE NATIONWIDE • 1-800-746-7464

**www.shoring.com**

## Blown Toilets?

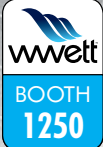

For Pipes  
 15" & up



**BL Swiper™**

Reduces incidences of  
 Blown Toilet Effect and with the  
 patented air channels can also be  
 used for Venturi Effect with pipes  
 full of water. Specially designed  
 material also makes it safe for  
 lined, PVC and sensitive pipes

For Pipes 8" to 18"

**Equipment Engineered for Long Lasting Performance™**



CALL  
 FOR A  
**FREE  
 DVD**



**NozzTeq®**  
 Taking Science to the Sewer!®

www.nozzteq.com  
 Toll Free 1.866.620.5915



Spinner™



C-Ray 800™



Paikert®



C-Ray 400™



Lumberjack®  
 75 series



Monro-Jet®



Jaws®



Hammerhead™



Lumberjack®



Orca™



Ice Bear™

### Trelleborg Pipe Seals expands operations in Lithuania

Trelleborg's Pipe Seals operation has recently integrated additional pipe liner production capabilities at its manufacturing facility in Taurage, Lithuania. The new technology was obtained from TWE/Trelit along with its customer base. The new manufacturing line started production in November and added a new product to the company's pipe liner portfolio, the Drainliner PP.



### Envirosight names channel development manager

Envirosight has announced the hire of Steve Webster as channel development manager. Webster will split his time between product and service management for the company's regional sales partners. With over 32 years of industry experience, he'll be tasked with conducting product launches and product demos.



### Ditch Witch annual international customer event draws largest attendance

Ditch Witch, a Charles Machine Works Company, hosted its annual internal customer event at the Ditch Witch Barcelona Support Center on Oct. 23. The event set a record with nearly 300 customers and staff from more than 20 countries.

### Aclara to acquire GE Grid Solutions' electricity meter business

Aclara has announced that its affiliate has signed an agreement to acquire the electricity meter business currently operating within GE Energy Management's Grid Solutions subdivision, also known as GE Meters. Terms of the transaction were not disclosed. **C**

**www.cleaner.com**

FOR DRAIN AND PIPE CLEANING, INSPECTION AND REHABILITATION PROFESSIONALS

# HYDROBLASTING MADE SIMPLER AND SAFER

Tired of replacing blown packing? Constantly lapping or replacing valves. Replacing blown rupture discs? Having to work on your pump in the field? Welcome to Hammelmann, a pump and accessories manufacturer for over 60 years. We offer the easiest to use, environmentally friendly and most reliable pump on the market up to 1500 HP.

## Simple

Hammelmann's exclusive ES 2 controller allows for a single individual to operate one or multiple pumps wirelessly while removing them from dangerous components making automation truly automated.



Based on SDM technology the ES 2 controls the complete high pressure pump unit.

The ES-2 controls diesel engine driven units or electrically powered units that are outfitted with a frequency converter. It constantly monitors and regulates system functions while collecting data from the various diagnostic functions.

Actual status data from the diesel engine is transmitted via CAN-Bus to the ES 2. All possible engine malfunctions appear as a fault code in the display with the most critical enhanced by clear text announcements.

## Rental locations



### Dayton / Miamisburg

Hammelmann Corporation - Headquarters  
436 Southpointe Drive, Miamisburg  
Ohio 45342  
Toll Free 1-800-783-4935

## Safe

Hammelmann pumps are fully contained. No water or oil to the ground from leaking packing lubricators or blown packing.



- 1 High pressure loaded components encapsulated
- 2 Friction free plunger sealing, no packing
- 3 Hermetic seal by bellows
- 4 No uncontrolled leakage



### Houston / La Porte

Hammelmann Corporation  
402 HWY 146 South, La Porte  
Texas 77571  
Toll Free 1-866-317-8677

## To rent

Hammelmann offers rental equipment for every job which includes pumps up to 1500 hp and pressures up to 55,000 psi.

### Water tools



3-D Tankcleaner, Aquablast surface cleaner, high pressure water blasting guns, 3-D Pipecleaner, hose rotating systems, abrasive cutting systems.

### High pressure units



Power ratings: up to 1500 hp  
Operating pressures: up to 55,000 psi  
Flow rates: up to 788 gpm



### Baton Rouge

Hammelmann Corporation  
37310 Commerce Lane, Prairieville  
Louisiana 70769  
Phone 225 384 54537



**HAMMELMANN®**

[www.hammelmann.us](http://www.hammelmann.us)

[mail@hammelmann.com](mailto:mail@hammelmann.com)

# **DR** DYNAMIC REPAIRS

**We Repair:**  
General Wire, Ratch, RIDGID, Hathorn Corp.  
Electric Eel, GatorCams, Vision Intruders  
and Vivax Inspection Cameras,  
Locators, Command Modules and Cables

**New & Refurbished Inspection  
Equipment For Sale**

**Rental Equipment Available  
Daily & Weekly Rates**

Ask  
About  
Our  
48-Hr.  
Turn  
Around  
Time

**INSPECTION CAMERAS  
ARE OUR  
ONLY BUSINESS!**

**973-478-0893**

**DYNAMIC REPAIRS**  
40 Arnot St., Unit 20  
Lodi, NJ 07644  
dynamiccablerepairs@yahoo.com  
www.dynamicrepairs.net



## WATER CANNON

**Honda  
Drain  
Cleaning  
Jetter**

4200 PSI  
w/pulsation 4 GPM - \$1,599

YOUR ONE-STOP SHOP  
FOR JETTERS, PRESSURE WASHERS,  
PARTS & MORE!

1-800-333-9274  
WaterCannon.com

wwett BOOTH 4257

# CEMTEC

Concrete  
Repair Products

## Cementitious Manhole Rehab Products

706.654.3677  
www.awcookcement.com

Let Us Build Your  
**JETTER**

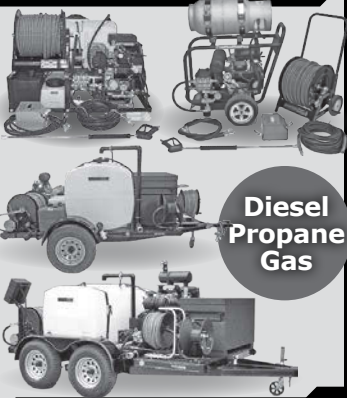

Diesel  
Propane  
Gas

**AMERICAN  
JETTER.COM  
866-944-3569**

## THE "ORIGINAL" LIQUID SMOKE



**Turbo Fog  
M45:**

- Versatile
- Light Weight
- Compact
- Creates Dense Smoke

**TURBO-FOG**  
Since 1977

wwett BOOTH 6114

www.turbo-fog.com • 1-800-394-0678

# ERICKSON

Tank & Pump



**509.785.2955**  
CALL FOR UPDATED LIST OF  
**EQUIPMENT**  
WWW.ERICKSONTANK.COM  
**Masport®**  
PUMPS & QUALITY COMPONENTS  
800 Rd. P5 S.W. / Quincy, WA 98848  
fax: 509.785.3770  
e-mail: sales@ericksontank.com  
"TANKS" FOR YOUR BUSINESS!

**WE TAKE TRADES**



**A Drainfield  
Restorative**

Septic Drainer

RCS II, Inc.  
518.812.0000  
septicdrainer.com

Over 25 years  
of building  
quality equipment



**HotJetUSA®**  
DRAIN LINE JETTING EQUIPMENT

**Most Versatile Jetter  
On The Market!**



- 35 HP Vanguard
- Remote Control
- Cleans Drains from 2"-12"

On Sale For Only  
**\$24,995!**

**Fully loaded! Call for details!**

**1-800-213-3272**  
www.hotjetusa.com

## T&T Tools, Inc.

800.521.6893



CALL  
for a  
**FREE  
Catalog**

Many styles  
Available

wwett BOOTH 6000

Insulated  
Soil Probes  
(for locating)

Heat-Treated  
Hooks  
(for covers, lids, etc)

www.mightyprobe.com



SUPPLYING THE  
ESSENTIALS IN THE  
UHP SURFACE  
PREPARATION  
INDUSTRY

All Jetting Technologies, Inc.  
772-286-1218

AT AFFORDABLE PRICES



- couplers and fittings
- pneumatically driven rotating jet lance
- numerous types of heat treated sapphire nozzles & tips
- variety of pump replacement parts
- distributor of Parker Hannifin hoses

Family owned  
and operated

**Ajt**  
Email: info@alljetting.com  
Phone: 772-286-1218  
www.alljetting.com

"Our customers come first"



**CONFINED  
SPACE  
ENTRY  
PACKAGE**  
ONLY \$2,995

The best package on the  
market includes:

- 4-Gas Air Monitor
- 7' Tripod
- 3-Way Fall Protection
- Work Winch
- Full Body Harness



wwett BOOTH 2062

Add a Blower with 15' of duct for only \$350!  
Add a 5 Minute Escape Respirator for only \$500!

**MTECH** 800.362.0240  
www.mtechcompany.com

Join A National Brand: www.RooterMan.com



# ROOTER-MAN

"To The Rescue"

NO ROYALTY ON PERCENTAGE OF SALES  
Franchise Package \$3,975

RESERVE YOUR EXCLUSIVE TERRITORY • Call 1-800-700-8062



# DO YOU RE-NU?

# RE-NU

WITH NU FLOW

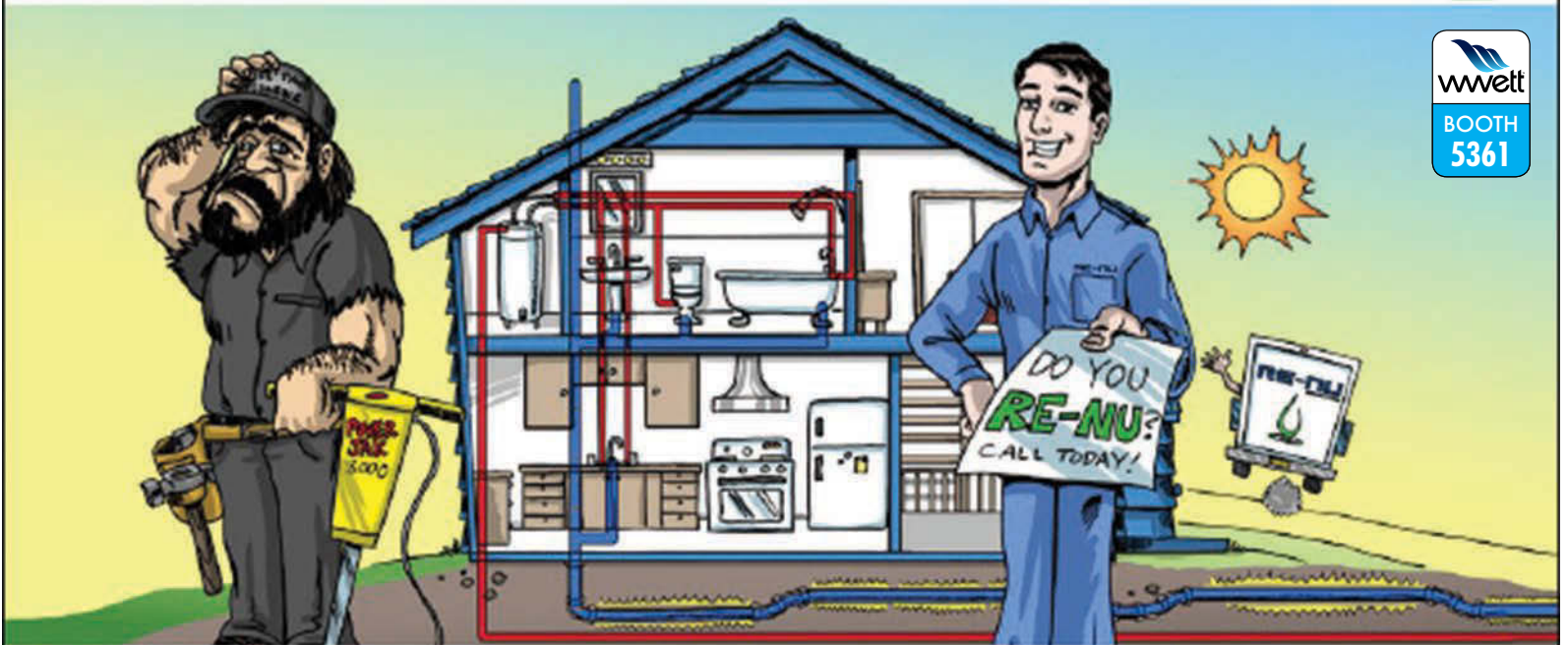
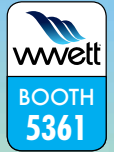

**Sanitary Systems**  
 Storm/Roof Drains, Vent Systems  
 Processed/Industrial/Chemical Piping  
 Mains, Horizontal Laterals, Vertical Stacks

**1-800-834-9597**  
[www.NuFlowTechnologies.com](http://www.NuFlowTechnologies.com)

**Fire Suppression**  
 Compressed Air Systems  
 Potable & Grey Water Systems  
 HVAC Systems, Conduit Piping



## Cua Claws

A Simple Solution for  
 Slippery PVC Pipe -  
**The Right Wheels**  
 We now resurface all makes  
 of steel transport wheels

CALL JERRY AT 714-697-8697  
[www.cuaclaws.com](http://www.cuaclaws.com)

## You Can Install Sewer and Water Lines (Without Digging A Trench)

**Pipe Genies Do It All!**  
 Ductile & Cast Iron, Clay & Concrete, ABS, PE  
 & PVC

**Pipe Genies Pull Any Pipe!**  
 System Power From 20 Tons to 240 Tons!  
 (Rated for 1/2" - 30" Pipe)

**Pipe Genies Work Anywhere!**  
 The Most Compact Systems Available!

We have everything you need to get started  
 making profits with pipe bursting!



[www.TrenchlessAmerica.com](http://www.TrenchlessAmerica.com)  
 Toll Free 1 877 411 7473

**BRIGHT DYES**  
 Division of Kingscote Chemicals

## DYE TRACERS

Solutions for:

- Infiltration
- Septic Systems
- Cross Connection
- Leaks and more...

**NSF**  
 Certified to ANSISF 60

**vwwett** BOOTH 6114

[www.brightdyes.com](http://www.brightdyes.com) • 1-800-394-0678

## Waterblaster Rentals & Sales

Houston, Texas

**Boatman Industries**

1K to 50K psi  
 60 hp to 1000 hp  
 Waterblasters & Accessories  
 Used Equipment Sales

**713-641-6006**  
[www.boatmanind.com](http://www.boatmanind.com)

## Superior<sup>®</sup> SMOKE

For SEWER TESTING

Superior Smoke Fluid Systems  
 Smoke Candles • Smoke Blowers

**vwwett** BOOTH 4116 **MADE IN USA**

Superior Smoke Testing  
 The Most Cost Effective Method to  
 Find Sources of Surface Inflow

[SuperiorSignal.com/Cleaner](http://SuperiorSignal.com/Cleaner)

## OBLITIROOT

SEWER LINE  
 FOAMING ROOT KILLER

Up to 3x the active ingredient

[www.olvidium.com](http://www.olvidium.com) (877) 477-5338

## BUSINESSES

**www.RooterMan.com.** Franchises available with low flat fee. New concept. Visit website or call **1-800-700-8062.** (CBM)

Plumbing business for sale in Amarillo, Texas. 33 years in business. 80' x 100' building built in 2001. 2015 Ford Transit, long and tall with shelves and Powerstroke diesel. Almost 1,400 repeat customers on QuickBooks. Will finance part. [hhplumbing1@sbcglobal.net](mailto:hhplumbing1@sbcglobal.net) 806-236-0727 (C02)

South Florida Plumbing company for sale. Specializing in drain cleaning and pipelining. In business since 1980. Owners want to sell. Gross sales between \$500K-\$600K this year. 3-4 full-time employees. Equipment includes pipelining tools, jetters, cameras, trailers, tools and vehicles. Looking for offers to purchase the company. Willing to finance part of the sale. Please email or text if you are interested. [Drainexpert@gmail.com](mailto:Drainexpert@gmail.com) 239-340-3840 (C03)

## CATCH BASIN CLEANERS

2006 Sterling Camel Hydrovac Automatic, 10-wheeler, 41,289 miles. 80gpm, 600' hose. Front reel. One owner. Sacramento, CA. Pictures upon request [cdscar@aol.com](mailto:cdscar@aol.com). Carroll 916-747-3819 (C02)

2004 Sterling Camel Hydrovac Automatic, 10-wheeler, 46,651 miles 80gpm, 400' hose, mid-mount reel. One owner. \$60,000. Pictures upon request @ [cdscar@aol.com](mailto:cdscar@aol.com). Carroll 916-747-3819 (C02)

## COMPUTER SOFTWARE

[FreeServiceReminderSoftware.com](http://FreeServiceReminderSoftware.com), [FreeServiceDispatchSoftware.com](http://FreeServiceDispatchSoftware.com), [FreeRouteManagementSoftware.com](http://FreeRouteManagementSoftware.com). (C02)

## DRAIN/SEWER CLEANING EQUIPMENT



**2003 Sterling 12-Yard Vac-Con Combo Unit:** CAT C12 engine, Eaton-Fuller transmission, Myers water pump, Rexroth hydro pump, Parker hydro motor, etc. \$99,000. For more info and pics, call

**904-284-2141, FL** C03



**2007 Vector 2103:** Excellent condition, city-owned maintained/serviced. 500-gallon freshwater, 3-yard debris tank. Water & debris tanks tied together for 1,200-gallon straight jetter use. Rotating hose reel - 500' x 3/4" hose. Rotating, extendable 6" boom, 40gpm @ 3,000psi. Vector pump, Roots positive displacement blower. Sterling Acterra 27,500 GVWR chassis, 38,500 miles, automatic transmission. Ready to work. Located in Houston Metro. ....\$78,500

**Call or text Jeff**  
**281-770-6714, TX** C02

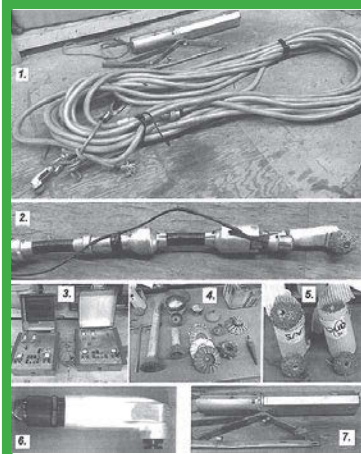

**Mainline Sewer and Drain cutting Equipment for Sale.** (1) Approximately 115 meters of DC-160 (Rg-90) air line (2) Aries DC-60 lateral cutting system WITH ADDED CAMERA (3) Control units for both the DC-160 (RG-90) + the DC60 (4) Various cutting tools and custom extensions (5) Cutting tools (6) Cutter motor (7) DC-160 (RG-90) cutter. There are other various custom parts and upgrades to the cutters.

**905-243-1063, ON** C02

Used and rebuilt cable machines in stock: RIDGID K-7500, K-40, K-60, K-1500, Spartan #1064, #300, #100, Electric Eel model #C machines. The Cable Center: 800-257-7209. (CBM)

## HAZARDOUS WASTE UNITS

New 3,200 U.S. gallon, carbon steel, DOT certified 407/412 vacuum tank; dump type with full open rear door and a Presvac PVB-750 vacuum-pressure pump installed on a 2016 Peterbilt 348 cab and chassis. (Stock #13634A-D) **www.VacuumSalesInc.com, (888) VAC-UNIT (822-8648).** (CBM)

1996 Ford with a Presvac 3,500-gallon, carbon steel, DOT vacuum tank with a Masport pump. (Stock #1829V) **www.VacuumSalesInc.com (888)VAC-UNIT (822-8648)** (CBM)

## JETTERS-TRAILER



**Xtreme Flow Trailer Jetter Hot/Cold!** Model# HJ2TA8536, tandem axle trailer, 35 hp Vanguard 10 gpm @ 3,850 psi, 325-gallon water tank, 300' hose, General Pump. List \$36,995. On sale for \$32,995. Fully loaded!

**800-213-3272**  
**www.hotjetusa.com** CBM



**2010 American Jetter 4012:** 180 hrs., 4,000psi @ 12gpm, 325 feet of half-inch hose, 200 gallon, on/off remote control, anti-freeze, Warthog w/s. ....\$15,000

**419-466-1530, OH** C02



**2003 Isuzu Harben 4018** Hatz 300-gallon diesel silent pack 18gpm @ 4,000 psi. Super clean. Ex-city, low-mile truck. Work ready. ....\$23,900

**800-627-0778** C02

2000 John Bean Trailer Jet: 35gpm @ 2,000psi. 400-gallon tank, 400' new hose. \$11,000 OBO. 231-325-0052 or 734-365-4035. (CBM)

Harben trailer jetter: 786 hours, diesel. Newer paint & lines. It runs and operates great. \$17,500. Scott 574-292-1059. Can pick up at the WWETT Show. For pictures: [www.ebay.com/itm/-/231791318640?](http://www.ebay.com/itm/-/231791318640?) (C02)

1990 Sewer Equipment Company of America 747 trailer jet for sale. 99% restored. \$4,500 OBO. Call 815-719-5513. (C02)

## JETTERS-TRUCK



**1993 GMC 1-ton Jetter:** 35gpm FMC pump, 3/4" hose, 500-gallon plastic tank. Excellent cold-weather machine. ....\$11,900 OBO  
Other jet trucks and trailers available.

**608-835-7767, WI** CBM



**2003 Isuzu Harben 4018** Hatz 300-gallon diesel silent pack 18gpm @ 4,000 psi. Super clean. Ex-city, low-mile truck. Work ready. ....\$23,900

**800-627-0778** C02

Jack Doheny Supplies Inc. offers a full range of late model combo units and DOT industrial vacuum loaders. Call us @1-800-3DOHENY. (CBM)

## JET VACS



**2005 Vac-Con** VPD4211LHA/1300 on International 7400: DT466 engine, Allison auto transmission, 88,640 miles. Deutz 138hp auxiliary engine, long telescopic boom, hydrostatic drive, articulating 600' x 1" hose reel, 1,300-gallon water tanks, 11-yard tank, 80gpm Roots 827PD blower. New final filter assembly recently installed. Well-maintained with records. ....\$75,000 OBO

**Mark 708-475-7100, IL** CBM



**Combination Cleaner/Hydro Truck:**

2013 Vactor Model 2115 Plus mounted on a Kenworth T440 6x4 chassis. 80gpm @ 2,500psi water pump, Roots 824 blower 18". Hydroexcavation circuit with 400,000 BTU boiler. 21,535 miles. Unit is loaded with options. Call for more details. .... \$275,000 OBO

**Jerry 317-538-8424** C02



**2000 Vactor 2100**, International, new fan, 80gpm, 2,500psi, 12-yard, 1,300 gallons, Hydroexcavation package, MultiFlow. Great shape. Ex-city unit, work ready. .... \$90,000 OBO

**Call Dave Marshall**  
**866-744-9921, WA** C03



**1998 Sterling Vactor 2100:** 12-yard, PD blower 2,000psi @ 4,000. Clean, ex-city unit. Work ready. .... \$47,600

**800-627-0778** C02

2004 Vactor 2100 Series: Single axle, 9-yard debris tank, 80gpm @ 2,500psi. Motor has only 14,500 miles/275 hrs. and auxiliary engine has 480 hrs. For pictures and more info visit our website at [www.mahoneysequipment.com](http://www.mahoneysequipment.com) or call 314-575-5168. (C03)

1994 Ford Vactor 2100 Series: 12,000 on chase 2040 on unit. Needs debris tank -- rusted out, everything else is in great shape. New aluminum water tanks 3 years old. Asking \$28,000. Call 815-228-9845 (C02)

2001 Vactor, Freightliner FL80, CAT, 2 fans, 80gpm @ 2,500psi, 2,000 gallons, Hydroexcavation package. Multi Flow, Cold-weather package, many other options. Great shape, recent service done on chassis and body. Ready to work. \$65,000. Call Dave Marshall 866-744-9921 (C04)



**2006 International Vac-Con:** 80gpm, 3-stage fan, 12-yd. debris tank, 96,923 miles, 11,063 hrs. Pony motor 2,351 hrs. .... \$115,000

**Call 877-389-2227, IN** C02



**2001 Freightliner Jet-Vac:** Vactor 2110-36 jet-vac w/PD blower, C-10 CAT, Allison auto., 46,000 rears, air-ride suspension. Ex-Water Dept. truck. Only 63,883 miles, 1,776 hours. .... \$69,975

**814-696-4343** C02



**1991 Ford Vactor:** L8000, 2112, PD blower, 12-yard. 80gpm w/ 2,000psi. Ex-city unit. Clean and work-ready. End-of-year sale ..... \$19,900

**800-627-0778, VA** C02



**Roots 821 PD blower** w/transfer case and (2) aluminum water tanks. ... \$5,000

**814-696-4343** C02

2008 Camel Combo: 73,000 miles, 6,700 hrs. 80gpm, 2,000psi. PD blower. Refurbished at authorized Super Products dealer. In-frame engine rebuild less than 4,000 miles. \$130,000. Call Bill 813-489-3108 (C02)

One (1) 2015 Freightliner Camel combo vac truck and one (1) Western Star combo vac truck. Both equipped with 824 blowers, ejector plates, 12-yd. debris tanks, 80gpm at 2,000psi water system, 1,500-gallon fresh water and 600' of 1" jet hose. Low hours and miles. Partial factory warranty. For pictures, pricing and more info, call Jeff 317-258-4900 (C03)

2002 Vac-Con Sterling 21,703 hours. Front axles 20,000, mid 20,000, rear 20,000. Gross axles 60,000. Side motor Cummins. Good running truck. New tires. Asking price \$45,000 USD. 905-809-1478 (C04)

2010 GapVax Model MC2008: International chassis, Allison MD/HD Series transmission w/10-bolt PTO upgrade. Engine: Maxxforce 13 w/400hp. Unit has 21,278 miles main engine, 631 blower hours, 1,730 water pump hours. Giant water pump set at 50gpm/3,000psi. 2,000-gallon water tank, 8-yard debris. Information/photos/pricing, contact Monty 303-632-8236 ext.303 (C02)

Refurbished 2000 AQUATECH B10, 10-yd. body, rebuilt 65gpm/2,000psi pump, GMC chassis, 95k miles. Auto. transmission. Ex-city unit. Full rebuild sheet available. Call 856-599-4838 [www.internationalinkllc.com](http://www.internationalinkllc.com) (C02)

2002 Sterling LT7501 Vac-Con Model V390LHA combination sewer cleaning truck: Freshly painted white. CAT 3126 - 275hp engine, 3-stage fan, 1,000-gallon water tanks, pump off option available. 10' telescopic boom. FMC water pump - 65gpm @ 3,000psi. Articulating hose reel with 600 feet of new 1" hose. 84,316 miles. Located in Orange, CA. \$79,900. Contact Craig: 714-639-8352. Additional details at [www.empireequip.com](http://www.empireequip.com) (CBM)

Vac-Con industrial machine mounted on a pre-owned 2006 Sterling cab and chassis. (Stock #8593C) [www.VacuumSalesInc.com](http://www.VacuumSalesInc.com) (888) VAC-UNIT (822-8648) (CBM)

Pre-owned Super Products jetting unit mounted on a 1995 GMC Kodiak Cab and chassis (Stock# 5620V) [www.VacuumSalesInc.com](http://www.VacuumSalesInc.com) (888) VAC-UNIT (822-8648) (CBM)

Vac-Con V390LHA combination unit with Roots 827 blower, 1999 International Model 2554 cab and chassis. (Stock #3918C) [www.VacuumSalesInc.com](http://www.VacuumSalesInc.com), (888) VAC-UNIT (822-8648). (CBM)

**LEASE/FINANCING**

**North Star Commercial Credit:** Commercial loans for trucks or equipment. Flexible purchase programs to fit your budget. 21 years in the industry. Contact **Tom Myers** - 877-804-2274. (CBM)

**LOCATORS**

Used RIDGID NaviTrack, Gen-Eye Model 100 and Goldak Model 4400. The Cable Center 800-257-7209. (CBM)

**NOZZLES**

**SAPPHIRE NOZZLES** for UHP, laser-etched, heat treated, excellent quality, fantastic savings! 772-286-1218. [info@alljetting.com](mailto:info@alljetting.com); [www.alljetting.com](http://www.alljetting.com). (CBM)

**PIPELINE REHABILITATION**



**LMK. 24-foot Pace wet out trailer.** Tank. Boss bullet. Mini steam cure. Like new -- call for details

**920-627-7867** C03

MaxLiner CIPP unit: Complete with compressor and heating system. Trailer-mounted. \$10,000 FIRM. 818-231-0417 or 818-704-1413 (C07)

One trade-in model of Pipe Genie heavy-duty, pipe bursting equipment. Excellent condition, looks new, 30-ton, 100 feet cable, full 2-year warranty. 877-411-7473. (CBM)

**POSITIONS AVAILABLE**

Taking applications for a future Drain Service Technician in Blackwood, NJ area. Offering competitive salary and great benefit package. We are a 24/7 emergency drain service response company that requires your residence to be within approximately 30 miles of Blackwood to perform on-call service. Clean driving record a must, background check and drug screening will be required. Email [info@drainvisions.com](mailto:info@drainvisions.com) (C02)

GapVax, Inc., a nationally recognized manufacturing business, is seeking a talented, highly motivated individual to fill a full-time Sales Position in the Midwest (Iowa based preferred) region. GapVax is the leading manufacturer of industrial and municipal vacuum units and hydroexcavation units in the United States. We provide the most reliable, comprehensive, and efficient mobile vacuum units in the industrial and municipal markets. Specifications of the position are listed on our website, [www.gapvax.com](http://www.gapvax.com), click on the Now Hiring link in the left hand column. Send resumes to [Lthomas@gapvax.com](mailto:Lthomas@gapvax.com) or 575 Central Avenue, Johnstown, PA 15902. (CPMGBM)

## POSITIONS AVAILABLE

Cooke's Plumbing and Septic is growing and we are looking for a Service Plumber/Service Technician to join our winning team in Florida's Treasure Coast. We are looking for exceptional candidates with: A passion for helping people and solving problems; Clean driving record; Experienced in service plumbing - residential and commercial. Experienced in drain cleaning and septic is a plus. Must be able to pass a drug screen and background check. Must have a good attitude and a willingness to learn. Must be a self-starter and be able to work independently. Must be willing and able to work in an on-call schedule, nights, weekends & holidays. We provide air-conditioned company vehicles, iPhone, tablet, uniforms, leak-detection equipment, drain-cleaning machines & sewer Cameras. Proud members of Nextstar, we use a Flat Rate Pricing Structure. Cooke's is the Premier Plumbing & Septic Company and offers exceptional training and the opportunity to earn top pay! Vacation, medical & dental. Please email your resume to: cayala@callcookes.com (C02)

**CUES Lateral Launch CCTV Operator with PACP Certification**, along with Jet Vac Truck and Hydroexcavator/Operators needed. Busy and growing Michigan based company (established in 1977) looking for experienced underground pipeline inspection camera lateral launch operator and CDL drivers for hydrovac, combination vac and high-pressure water jet (sewer and catch basin cleaning) trucks. Mid-Michigan and outlying areas. Positions to start immediately. Experience with CUES equipment, Granite Software and Lateral Launch computer software helpful for the Camera Operator position. 401k, health insurance, eye and dental available. Competitive wage based on experience. Call Jake or Ronnie at 989-892-5828, bring or mail resume with references to 512 McGraw Street, Bay City, MI 48708. Email jakefoco@dependablesewer.com. Full-time, year-round positions. (C03)

Looking for Utility Operator/Crew Leader to work in metro and rural Minnesota as well as outlying areas. Preferred requirements: Experience running televising equipment including lateral launch systems with PACP certification and knowledge and operation of combination jet-vac trucks. Please apply even if knowledge-based requirements are not fully met. Looking for future team members to have a positive attitude and a self-starter mentality with the ability and comfort to lead other team members. We offer negotiable, very competitive wages based on experience. Retirement plan and health insurance is available. Call 507-388-1945 or email resume to swenner@empire-pipe.com. Come help us make a better future for yourself and our team. (C04)

## PUMPS

Honda model WP40X, 8 hp, 4" with hoses. Honda 4 hp, 2" pump with hoses. The Cable Center: 800-257-7209. (CBM)

## RENTAL EQUIPMENT

Liquid vacs, wet/dry industrial vacs, combination jetter/vacs, vacuum street sweeper & catch basin cleaner, truck & trailer mounted jetters. All available for daily, weekly, monthly, and yearly rentals. **VSI Rentals, LLC, (888) VAC-UNIT (822-8648) www.vsirentalllc.com.** (CBM)

## SERVICE/REPAIR

**Dynamic Repairs - Inspection Camera Repairs:** 48 hour turn-around time. General Wire, Ratech, RIDGID, Electric Eel Mfg, Gator Cams, Insight Vision, Vision Intruders. Quality service on all brands. **Rental equipment available.** For more info call Jack at 973-478-0893. Lodi, New Jersey. (CBM)

## TOOLS

RIDGID model #300 with stand, RIDGID tri-stand vises, RP 330 ProPress kit. The Cable Center: 800-257-7209. (CBM)

Bosch Brute hammer drill with cart irons. The Cable Center: 800-257-7209. (CBM)

**T&T Tools:** Probes, hooks. Probes feature steel shafts with threaded and hardened tips. The insulated **Mighty Probe™** tested to 50,000 volts. **Top Poppers™** open man-hole covers easily. Free catalog. **www.TandTtools.com.** Phone **800-521-6893.** (CBM)

## TRUCKS - MISC.



**2003 Freightliner FL120SD:** Very nice truck. Cummins ISM Cummins engine, 410hp. Allison A/T. AquaTech B10 body w/624 blower. 2,010 hours, 45K miles. \$94,000

**319-521-8175, IA** C02

**Cleaner**  
AVERAGE MONTHLY  
CIRCULATION REACHES  
**26,460**  
READERS!



**2006 International 7600 Vactor 2110** body, CAT C13 engine, 410hp. 1,500-gallon water, 80gpm @ 2,500psi jetter pump, 824 PD blower, tandem axles. \$109,900

**Call Todd Summers**  
**319-521-8175, IA** C02

## TV INSPECTION



**2004 UEMSI Main Line TV System,** track transporter, 1,000' reel, pan/tilt camera, computer & software, trailer with a/c, generator & air compressor. \$29,950

**334-693-9507, AL** C04



**1999 Ford E450 Hi-Cube CUES TV** Inspection with Cobra Data Logger software. New automatic transmission with warranty. New rooftop a/c with warranty. Trans on Ultra Shorty rec. rebuilt. New 1,000' SS cable, etc. \$35,000 negotiable. For further info and pics call

**904-284-2141, FL** C03

USED Envirosight ROWVER System: Brand new RC90 camera. Cable reel (SN 360570) has new power supply, motor, clutch, cable (656') and winding rollers. 125 crawler (SN 0260768) has new top plate, side plates, axles and seals, plus new control board compatible with rear-view camera accessory (not included). CCU (SN 0160981) with new power card, new 56V card, new +/-26 card, and new card. Control pendant (SN 0492645) is compatible with RC90 camera and R225 crawler. \$27,500. Call 973-252-6700. (CBM)

2006 CUES CCTV Chevy 2500 High Cube. Steerable transporter pipe ranger. OZ II camera gold cable. New PCU, new computer. Rebuilt Onan generator. Engine replaced 40k ago. New paint, tires and seats. \$55,000. Call Bill at 813-489-3108. (C04)

CUES 2004 Chevy Express video inspection unit 118,000 miles. OZII camera, UltraShorty transporter, Minipush 20/20 with locator. Datacap 4.0 software. \$40,000 OBO. 503-849-2581 (C02)

PEARPOINT — Mainliner buying & selling used equipment. Canada & USA PEARPOINT MAINLINE EQUIPMENT ONLY. Will buy complete Pearpoint trucks. Will buy your old system. Do you need parts? 399, 599 reels; 420, 448 tractors: 494 digital and zoom 420 light heads. Call 800-265-4298 or mainliner2075@hotmail.com (C04)

2001 Chevy 2500 TV Van, 29,949 miles, RST Camera & tractor, POSM Software, Onan generator. \$35,000. Pictures upon request @ CDSCAR@aol.com Carroll 916-747-3819 (C02)

Used SeeSnake Camera Systems in all sizes; Used General Wire Spring Camera Systems in all sizes; Used machines in all sizes. We want your trade! The Cable Center: 800-257-7209. (CBM)

Used and rebuilt camera kits in stock: RIDGID Mini Compact, Mini Color, Standard Self-Leveling, General Gen-Eye I, II and III, Aries Seeker, and SRECO kits. The Cable Center: 800-257-7209. (CBM)

## WANTED

Wanted to Buy: Vactor 2100s and late model Guzzlers. Cash. 800-336-4369. (CBM)

## WATERBLASTING

Gardner Denver T-375M: Bare Shaft pump. Gardner Denver T450M Bare Shaft pump. Gardner Denver TF-375M 21 gpm @ 10,000 psi. Gardner Denver TX-450HB 21gpm @ 20,000 PSI. Gardner Denver TF-450MB 52gpm @ 10,000 psi. NLB 10-200. 34 gpm @ 10,000 psi. HT-150S 25 gpm max 10,000 psi max, Shell Side Machine, Wheatley 165: 30 gpm @ 10,000 psi. Wheatley 125 with aluminum bronze fluid end. Boatman Ind. 713-641-6006. View @ www.boatmanind.com. (CBM)

WATER JETTING EQUIPMENT: We sell, repair and retrofit water blasters. Visit us at: www.waterjettingequipment.com or phone 714-259-7700. (CBM)

40,000 psi Sapphire Nozzles, UHP hoses & replacement parts. Excellent quality & prices. 772-286-1218, info@alljetting.com, www.alljetting.com. (CBM)

PLACE YOUR AD ONLINE AT [www.cleaner.com](http://www.cleaner.com) - IT'S ALWAYS THERE TO MEET YOUR BUSY SCHEDULE



**24 HOUR TURNAROUND - MIDWEST'S LARGEST FACTORY AUTHORIZED  
REPAIR CENTER FOR GEN-EYE, GATORCAM & SEESNAKE**

## ClogChopper™

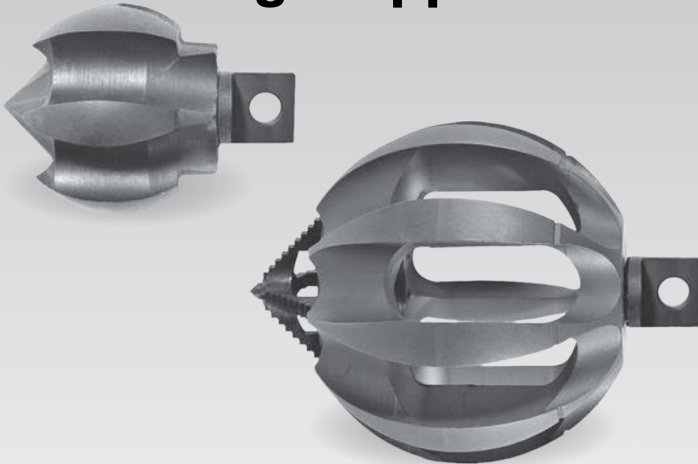

- Multi-function cutting tools
- Six self-sharpening blades
- Risk-free pipe damage
- Maneuvers around tight bends
- Safe cleaning on metal, plastic and clay pipes
- Variety of sizes
- Connector options for most drain cleaning machines

**CALL FOR PRICING!**

## NEW Gen-Eye Hot Spot™ Pipe Locator



- Easy to read display – Icons lead you to your target and auto backlight lets you locate in dimly lit areas.
- Total field antenna array – Allows you locate from any direction.
- Line direction compass – Tells you the lay of the pipe.
- Industry's most rugged locator – Rated IP65, the industry's highest, it is dust and dirt proof and water resistant.
- Superior Battery Life – Batteries lasts twice as long as other brands.
- Expanded Frequencies – Locates two sonde frequencies, two power frequencies and four line frequencies.
- Upgradeable Software – Use the USB port to upgrade software in the field.

**CALL FOR PRICING!**



**General J-2900**  
Basic Unit Machine Only

**\$2745**  
FREE DELIVERY



**General J-1450**  
**Portable Jetter**  
Basic Unit Machine Only

**\$1540**  
FREE DELIVERY



**Mini-Rooter XP™**  
Basic Unit – No cable cutters  
or power feed

**\$580**  
FREE DELIVERY



**General Speedroooter 92™**  
Basic Unit – No cable cutters  
or power feed

**\$1160**  
FREE DELIVERY

**FREE FREIGHT ON ALL CAMERA KITS**



Pressure Washers, Replacement Engines, Pumps, Parts & Accessories

# FLASH SALE

FREE DELIVERY  
On Sale Priced Items

NOZZLES

QC 4 PACK



~~\$9.99~~  
\$9.49

ADJUSTABLE TURBO



~~\$59.99~~  
\$51.99

ROTATING 4K



~~\$39.99~~  
\$29.99

UP TO 20 GPM



~~\$129.99~~  
\$115.99

REPLACEMENTS

TRIGGER 4K



~~\$14.99~~  
\$13.49

TRIGGER 5K



~~\$24.99~~  
\$24.99

RECOIL



~~\$15.99~~  
\$9.93  
10+

26.4GPM@1800PSI



\$1,499

ACCESSORIES

JETTER KIT



\$49.99

HYDROEXCAVATION WANDS



ALL SIZES AND FLOWS

SURFACE CLEANER ROLL CAGE FRAMES



~~\$299~~  
\$285



\$169.99

WASHERS

HONDA 4200 PSI JETTER



Base Model  
\$1,099

\$1,399

5000 PSI & REEL



~~\$4,965~~  
\$4,449

HOT WATER



~~\$3,899~~  
\$3,665

DIESEL HOT WATER



\$300  
P/M

7gpm @ 4000psi

WaterCannon.com

30  
YEARS OF  
SERVICE

1.800.333.WASH (9274)



Industry Trained Staff available from 8:30 a.m. to 7:00 p.m. weekdays E.S.T.

Water Cannon, Un contacto en Espanol: llama al: 1.800.917.9274

Orlando | Phoenix | Minneapolis | Hattiesburg | Melbourne | Toronto | Bogota  
International: 1-321-800-5763

Water Cannon  
is proud to be a  
MWBE



# GapVax

Your Number ONE Choice  
Manufacturer of  
Combination JetVacs,  
Hydro Excavators,  
Air Movers,  
SKID-MOUNTED VAC UNITS  
& MORE!

 **PARTSEXPRESS**

JOHNSTOWN, PA  
888-442-7829

DEER PARK, TX  
281-884-8658

  
Feb. 17-20, 2016  
Indianapolis Convention Center  
**wwett16**  
Water & Wastewater Equipment, Treatment & Transport Show

STOP BY AND SEE US  
AT LUCAS OIL STADIUM

Weds & Thurs 5-8p

~Happy Hour in GapVax Stadium booth~

EXHIBIT HALL OPEN THURS-SAT

**BOOTH  
6004**

[www.gapvax.com](http://www.gapvax.com)



CHECK OUT OUR PARTSEXPRESS CATALOG ONLINE! CALL AND SAY HELLO TO ZACH CUMMINS, NEW ADDITION TO OUR PARTS TEAM!

# A SIGHT TO BEHOLD.



Now  
Available for  
Android

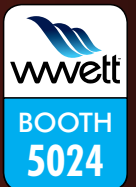

**SPARTAN**  
FOR TOUGH CUSTOMERS.  
SINCE 1943

The future is at your fingertips with Sparvision 200, a state-of-the-art pipe-inspection camera designed with you in mind. Featuring a wireless retina-display iPad® 4 as its screen, the Sparvision 200 offers full tablet computer features like instant snapshots, on-screen drawing and a touch keyboard for captions. With the Wi-Fi-enabled iPad, simply send the photo or video you shot directly to the customer and store your copy right on the tablet. The Sparvision 200 offers a self-leveling color camera, a 512 Hz locating beacon and a 200' high-efficiency, super-slick push rod. Plus, the entire unit is powered in the field with an on-board battery so you can take it anywhere. **If you're looking for the best, look no further.**