

# Cleaner

FOR DRAIN AND PIPE CLEANING, INSPECTION AND REHABILITATION PROFESSIONALS

www.c... FEBRUARY 2015



Feb. 23-26  
Indianapolis, Ind.

**ENTERTAINMENT  
PREVIEW**

**PAGE 26**

## GROWING WITH THE INDUSTRY

CALIFORNIA CONTRACTOR TARGETS  
MUNICIPAL WORK AND MOVES BEYOND  
STANDARD CLEANING SERVICES **PAGE 16**

### **MONEY MACHINES**

Ramjets provide reliable service

### **SAFETY FIRST**

A new approach to accident reduction

### **MONEY MANAGER**

Even small companies can be victims of fraud



# Gen-Eye SDW<sup>®</sup>

with WiFi inside 

## New Enhancements, Added Versatility

General's beefed up Gen-Eye SDW video pipe inspection and location system now features a

- Larger, 10.4" LCD screen.
- Built-in waterproof keyboard.
- Integral SD recorder.
- WiFi transmits video to tablet or smartphone.
- All in a new, heavy-duty Pelican case.

For details, contact the Drain Brains<sup>®</sup> at 800-245-6200 or 412-771-6300, or visit [www.drainbrain.com/geneye](http://www.drainbrain.com/geneye).



See what you've been missing: [www.drainbrain.com/geneye](http://www.drainbrain.com/geneye)

**General**  
PIPE CLEANERS

**The toughest tools down the line.™**



© General Wire Spring 2014



ONE OF THE 1ST  
VAC-CON TRUCKS - 1986

ONE OF THE LATEST  
VAC-CON TRUCKS

BETWEEN  
THESE  
*two* TRUCKS ARE  
6,500  
OTHERS  
STILL *running*  
WORLDWIDE



Each truck is supported by our robust dealer network, customer service and comprehensive on-line training.

Our manufacturing records date back to the first unit produced in 1986. We have the capabilities of providing you with technical service documents and parts for every single unit we have produced. Whether you have questions about parts or technical service, well-trained and dedicated personnel are standing by throughout the Vac-Con® network of dealers and service providers to assist you. [GO ON-LINE TO LEARN MORE.](#)

[VAC-CON.COM/worldwide](http://VAC-CON.COM/worldwide)

VAC-CON IS A SUBSIDIARY OF HOLDEN INDUSTRIES, INC., A 100% EMPLOYEE-OWNED COMPANY.

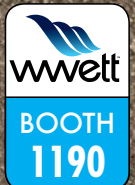

**VAC-CON**  
MORE POWER TO YOU

A HOLDEN INDUSTRIES Company





# WARTHOG

SEWER NOZZLES BY **STONEAGE**

**CLASSIC SERIES**

**NEW**  
**WGR MAGNUM**



WV WT WS WHP WG WD WGP

**MANY APPLICATIONS. ONE SOLUTION.**

**DESTROYS ICE, GREASE,  
ROOTS, DIRT & DEBRIS.**



**WARTHOG**  
SEWER NOZZLES BY **STONEAGE**

1-866-795-1586 • WWW.SEWERNOZZLES.COM

**SEE YOU AT THE 2015 WWETT SHOW!**

Visit us at Booth #5134

Proudly Manufactured in the USA





underground  
understood

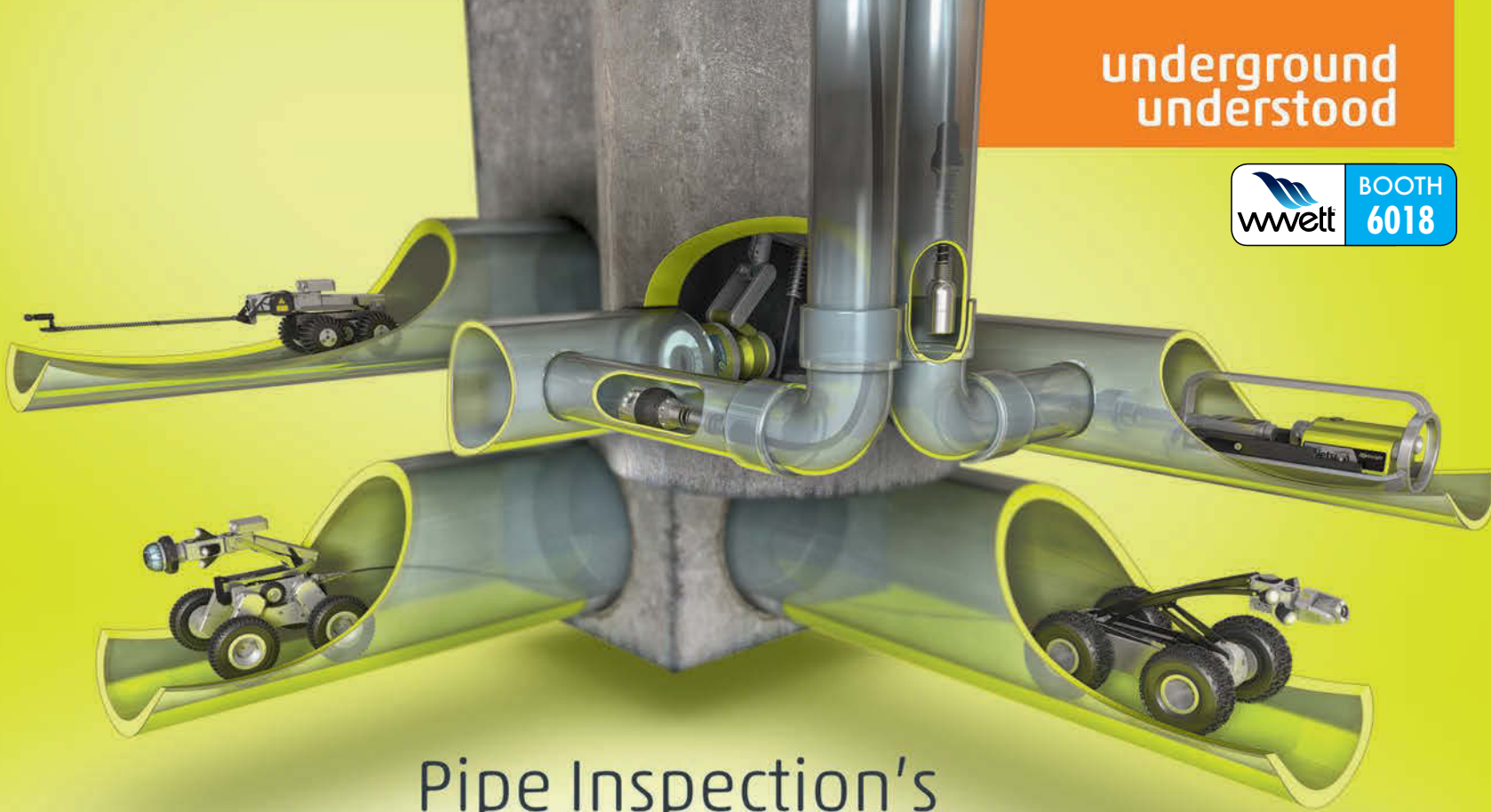

# Pipe Inspection's All-star Lineup

new

## preferred build-outs

We've analyzed the most popular inspection vehicle configurations and geared up to deliver them faster and more affordably. Order with confidence knowing your build-out reflects industry preferences.



updated

## crawlers

Pan/tilt SAT is updated with new controls, drive train and camera; new RX400 crawler inspects pipe up to 10' dia.



new

## pan/tilt push camera

Reaching as far as 330' into laterals, VeriSight Pro 360 tilts  $\pm 135$  degrees and pans 360.



new

## video nozzle

Now view lines up to 24" with JetScan extension rollers, and record up to 16 hours of footage.



ROVER X dominates our industry—it's the most agile, capable crawler out there, with a single system letting you perform CCTV, lateral launch, side scanning and laser profiling in any size line.

But let's face it, even a performance crawler like ROVER X isn't always the best way to see inside pipe. That's why EnviroSight has pioneered game-changing technologies like zooming and video nozzles, and why we've perfected the push camera.

Ultimately, Underground Understood is about having the best equipment to answer any inspection challenge. **Schedule a free on-site demo and find out what it means to go all-star.**



**EnviroSight**

[www.envirosight.com](http://www.envirosight.com) • 973.252.6700

inspection technology • asset strategies





## features

- 16 **Profile: Growing with the Industry**  
California contractor targets municipal work and moves beyond standard cleaning services.  
By Mary Shafer
- 26 **WWETT Preview: On the Rise**  
Budding country music star Cole Swindell headlining the WWETT Industry Appreciation Party.  
By Kyle Rogers
- 36 **Profile: Small Company, Big Systems**  
Combined experience and planned strategy help business partners climb the ranks of Twin Cities cleaning contractors.  
By Marian Bond
- 68 **WWETT Preview: World Health Organization talk slated for WWETT Show**



**ON THE COVER:**  
Downstream Services founders Wilma and Victor Roberts pose for a portrait in the company's shop in Escondido, Calif. The company, which has nearly doubled in size over the past decade, offers comprehensive pipeline inspection, cleaning and repair, along with municipal wastewater system operation and maintenance. (Photography by Collin Chappelle)



## departments

- 12 **From the Editor: The Evolution of Our Industry**  
Take advantage of opportunities to grow, improve operations and expand into new services.  
By Luke Laggis
- 14 **@cleaner.com**  
Be sure to check out our exclusive online content.
- 32 **Money Manager: The Threat Within**  
Fraud isn't something that only takes place at huge corporations; it could be going on right under your nose.  
By Judy Kneiszel
- 46 **Money Machines: No Time for Downtime**  
Reliability of Ramjet jetting trucks improves efficiency and makes customers happy.  
By Ken Wysocky
- 54 **Better Business: Be a Better Boss**  
There are specific, key leadership characteristics that all employees want from management.  
By DeEtta Jones
- 72 **Safety First: Predicting Safe Outcomes**  
A new approach to accident prevention goes beyond the traditional principles.  
By Doug Day
- 76 **Product News**  
Spotlight: Spider cutter cleans in both directions.  
By Ed Wodalski
- 82 **Industry News**

## COMING IN MARCH 2015

### ISSUE FOCUS:

#### Field and Office Technology

- **MONEY MACHINES:** Spartan Sidewinder handles tough jetting jobs
- **TOUGH JOB:** Utah contractor tackles triple burst
- **TECH PERSPECTIVE:** Going paperless yields big efficiency gains



# PERMA-LATERAL™ LINING SYSTEM

THE BEST SELLING SMALL DIAMETER PIPE LINING SYSTEM IN NORTH AMERICA

REPAIRS CRACKED OR BROKEN PIPES WITHOUT EXTENSIVE EXCAVATION

ELIMINATES ROOTS AND INFILTRATION

BRIDGES MISSING PIPE SECTIONS / STAND ALONE REPAIR

PATENTED TECHNOLOGY



**LIVE DEMOS**

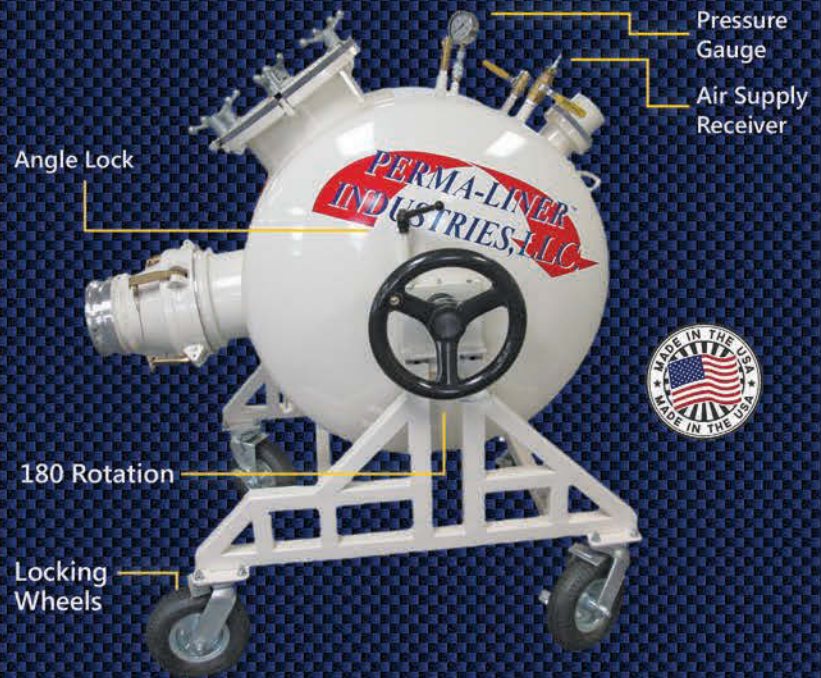

## PERMA-LATERAL™ DIRECTIONAL SHOES

Allows the installer to direct the liner and calibration tube upstream or downstream, while lining through a cleanout.



## PERMA-LATERAL™ STEAM CURE

Allows the installer increased productivity with cure times less than one hour. Compact, user-friendly and allows the installer maximum working time while still using 100% solids epoxy.



## PERMA-LATERAL™ PATENTED SCRIM REINFORCED INVERSION LINER

The Perma-Lateral™ Scrim reinforcement eliminates stretch in the liner while inverting. There is no chance for the liner stretching and protruding past the termination point.



## PERMA-LATERAL™ CAMERA INSPECTION PORT

Allows a lateral push camera to be inserted inside the clear calibration tube, providing a visual certification of the liner placement prior to curing.



[www.perma-liner.com](http://www.perma-liner.com)

1-727-507-9749 Int'l 1-866-336-2568 Toll Free

info@perma-liner.com

COVERED BY US PATENT NOS. 8,590,575; 7,343,937; 7,448,413; 7,588,055; AND 7,753,081

**PERMA-LINER™  
INDUSTRIES, LLC.**



# Increase Your Profits With The Natural Solution



DRAINBO's Drain Treatment & Cleaner offers class leading performance and peace of mind. While giving you a Safe, All-Natural solution to offer.



DRAINBO's Grease Trap Treatment keeps the system operating at peak efficiency. It decreases pumping by up to 70% while increasing profits.



Private Labeling Available  
Money Back Guarantee on all products

**DRAINBO** 877-372-4626  
www.drainbo.com

## TRYTEK 3" to 6" Lateral Cutter



### NEW! TRYDENT 80 Cutter System

- > For interior or exterior relined pipes
- > Access pipe systems through clean-out ports or rooftop vents
- > Navigate standard 90 degree elbows in 3" pipe
- > Includes 100' of hose reach



www.trytek.com

Contact us for more information:  
Phone: 717-428-1477  
Fax: 717-428-2865  
Email: trytek@trytek.com  
250 N. Main St.  
Jacobus, PA 17407 USA

Serving the  
industry for over  
**25 years**

## Cleaner

FOR DRAIN AND PIPE CLEANING, INSPECTION AND REHABILITATION PROFESSIONALS

Published monthly by COLE Publishing, Inc.  
1720 Maple Lake Dam Rd., PO Box 220, Three Lakes, WI 54562

Call toll-free 800-257-7222 | Outside of U.S. or Canada call 715-546-3346  
Mon- Fri., 7:30 a.m.-5 p.m. CST

Website: www.cleaner.com | Email: info@cleaner.com | Fax: 715-546-3786

**SUBSCRIPTION INFORMATION:** A one year (12 issue) subscription to *Cleaner* in the United States or Canada is free to qualified subscribers. A qualified subscriber is any individual or company in the United States or Canada that is involved in the inspection, cleaning, repair and installation of residential and commercial sewer lines. Non-qualified subscriptions are available at a cost of \$60 per year in the United States and Canada/Mexico. Subscriptions to all other foreign countries cost \$80 per year. To qualify, visit www.cleaner.com/order/subscription or call 800-257-7222.

Our subscriber list is occasionally made available to carefully selected companies whose products or services may be of interest to you. Your privacy is important to us. If you prefer not to be a part of these lists, please contact Nicole at nicole@colepublishing.com.

**CLASSIFIED ADVERTISING: RATE:** No Photo Classified \$25 for 20 words, each additional word \$1. All classified advertising must be PAID IN ADVANCE. DEADLINE: Classifieds must be received by the first of the month for insertion in the next month's edition. PHONE-IN ADS ARE NOT ACCEPTED. Ads may be faxed only when charging to MasterCard, VISA, Amex or Discover. Please supply all credit card information with faxed ads. Be sure to include your phone number (with area code) in your ad. Make checks payable to COLE Publishing Inc. and mail with classified ad to the address above. CLASSIFIED ADVERTISING APPEARS NATIONWIDE AND ON THE INTERNET. Not responsible for errors beyond first insertion.

**DISPLAY ADVERTISING:** Contact one of our sales staff at 800-994-7990. Publisher reserves the right to reject advertising which in its opinion is misleading, unfair or incompatible with the character of the publication.

**REPRINTS AND BACK ISSUES:** Visit www.cleaner.com for options and pricing. To order reprints, call Jeff Lane at 800-257-7222 (715-546-3346) or email jeff@colepublishing.com. To order back issues, call Nicole at 800-257-7222 (715-546-3346) or email nicole@colepublishing.com.

**CIRCULATION:** Circulation averages 27,756 copies per month. This figure includes both U.S. and international distribution.

© 2015 COLE Publishing Inc.

No part may be reproduced without permission of the publisher.



Kayla Bisnette Jim Koshuta



GET  
SOCIAL  
WITH  
**Cleaner**

- f [www.facebook.com/CleanerMag](http://www.facebook.com/CleanerMag)
- t [www.twitter.com/CleanerMagazine](http://www.twitter.com/CleanerMagazine)
- g+ [www.plus.google.com](http://www.plus.google.com)
- yt [www.youtube.com/CleanerMagazine](http://www.youtube.com/CleanerMagazine)
- in [www.linkedin.com/company/cleaner-magazine](http://www.linkedin.com/company/cleaner-magazine)



### WATER & WASTEWATER EQUIPMENT, TREATMENT & TRANSPORT SHOW

EDUCATION DAY: Feb. 23, 2015  
EXHIBITS OPEN: Feb. 24 - 26, 2015

Indiana Convention Center  
[WWW.WWETT.COM](http://www.wwett.com)





# **TRENCHLESS** is a puzzle we solve daily

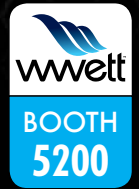

**WE CAN FIT ALL THE PIECES TOGETHER FOR YOU.**  
You could get your liner, epoxys and resins from one guy. Your wet-out table and inversion drum from someone else. Maybe another company has a pipe-inspection camera that looks like it would work, and yet another outfit has some cutters that you could use. Of course, if you need pipe-bursting equipment, you talk to a totally different guy... Or you could just let the Trenchless experts at HammerHead put it all together for you. The best products. Bonafide expertise. All from a single source that has been earning your trust for over 25 years.



HEAD ON OVER TO [WWW.HYDRALINER.COM](http://WWW.HYDRALINER.COM) TO LEARN MORE ABOUT HAMMERHEAD'S COMPLETE TRENCHLESS LINE-UP.

MOLING | RAMMING | BURSTING | HDD ASSIST | WINCHES | CIPP



**A**

A Corp/Rooter-Man .....84

A.R. North America, Inc. ....82

Advanced Infrastructure Technologies .....12

**ALLAN J. COLEMAN**  
SINCE 1905

Allan J. Coleman Co. .... 23, 77

**AMAZING MACHINERY**

Amazing Machinery, Inc. ....63

Arctic Blasters, Inc. ....34

**ARIES INDUSTRIES, INC.**

Aries Industries, Inc. ....35

Arthur Products Co. ....66

**C**

Cable Center, The ..... 53, 94

**CAM SPRAY**

Cam Spray .....68

Canplas Industries, Ltd. ....71

**CAT PUMPS**

Cat Pumps .....21

**CENTRAL OKLAHOMA WINNELSON**

Central Oklahoma Winnelson .....70

**Root Rat**

Chempure Products Corp. ....80

CIPP Services, Inc. ....89

Cloverleaf Tool Co. ....50

**COAST MANUFACTURING**

Coast Manufacturing .....88

**CUES**

CUES ..... 40, 49

**D**

Ditch Witch .....79

Doug Meadows Co. LLC .....34

DRAINBO .....8

**DRAINABLES DIRECT**

Drainables Direct .....31

**DURACABLE**  
Manufacturing Company

Duracable Manufacturing Co. ....57

**E**

**Electric Eel**

Electric Eel Mfg. ....74

**Envirosight**

Envirosight, LLC .....5

**ENZ USA INC.**

Enz USA, Inc. ....48

**F**

**Solutions**

F. S. Solutions .....28

Forbest Products Co. ....80

**G**

**GapVax**

GapVax, Inc. ....95

**General PIPE CLEANERS**

General Pipe Cleaners .....2

**GORLITZ SEWER & DRAIN, INC.**

Gorlitz Sewer & Drain, Inc. ....61

**GUZZLER**

Guzzler Manufacturing .....15

**H**

Hammelman Corp. ....44

**HAMMERHEAD**

HammerHead Trenchless Equipment .....9

**Hannay Reels**  
The real leader

Hannay Reels .....39

Harben, Inc. ....41

**HATHORN**

Hathorn Corporation .....84

**J**

J. Hvidtved Larsen US .....73

**Jetstream**

Jetstream of Houston .....59

**K**

**Ken-Way**

Ken-Way Corporation .....74

**L**

**Lansas**

Lansas Products .....18-19

LaPlace Equipment Co. ....88

**Liberty Financial**

Liberty Financial Group, Inc. ....11

**EMK TECHNOLOGIES**

LMK Technologies .....85

**M**

MaxLiner USA .....47

**MRP**

Milwaukee Rubber Products, Inc. ....48

Mongoose Jetters by Sewer Equipment ...67

**MyTana**

MyTana Mfg. Company, Inc. ....83

**N**

**NLB Corp.**

NLB Corp. .... 25, 51, 70

**NozzTeg**  
Taking Cleaners To The Next Level

NozzTeg, Inc. ....84

Nu Flow .....53

**O**

**OceanQuip LLC**

Oceanquip Cables, LLC .....24

**P**

Pearpoint/SPX .....66

**PERMA-LINER INDUSTRIES**

Perma-Liner Industries, LLC .....7

Petersen Products Co. ....74

**PHCC**

PHCC-GLAA .....30

**PICOTE**

Picote Solutions .....42

**Pipeline Analytics**

Pipeline Analytics .....34

**PIPELOGIX**

PipeLogix, Inc. ....33

Piranha Hose Products .....66

**PRIMELINE**

PrimeLine Products, Inc. ....87

**Pulsar 2000**  
Line Tracer

Pulsar 2000, Inc. ....50

**Q**

Quik-Lining Systems, Inc. ....80

**R**

**RapidView IBAK**

RapidView IBAK North America .....69

**Ratech**  
ELECTRONICS

Ratech Electronics, Ltd. ....42

**REELCRAFT**

Reelcraft Industries, Inc. ....30

**ROOTX**

RootX ..... 11, 13

**RS Technical Services, Inc.**

RS Technical Services, Inc. ....55

RYCOM Instruments, Inc. ....24

**S**

**SAFETY SEWER DRAIN**

Safety Sewer Drain .....84

**SCOOPER**

Scooter Video .....45

**SOUTHLAND TOOL, INC.**

Southland Tool Mfg., Inc. ....43

**SPARTAN**

Spartan Tool, LLC .....96

**STONEAGE**

StoneAge, Inc. ....4

Stutes Enterprise Systems .....81

**T**

**T&T TOOLS**

T&T Tools, Inc. ....28

**TRYTEK**

TRY TEK Machine Works, Inc. ....8

**U**

**UltraShore PRODUCTS**

Ultra Shore .....68

US Jetting, LLC .....75

**V**

**VAC-CON**

Vac-Con, Inc. ....3

**VACALL**

Vacall-Gradall Industries .....65

Victor Manufacturing .....52

**VARCO**

VARCo .....44

**VIVAX METROTECH**

Vivax-Metrotech Corp. ....56

VSI Rentals. ....13

**W**

**Water Cannon**

Water Cannon, Inc. - MWBE .....29

Westmoor Ltd. ....56

**Marketplace** ..... 86

**Classifieds** ..... 90



# Flexible and Affordable Financing Options



## Financing for New and Used Equipment:

Trucks                      Tanks  
Trailers                     Toilets  
Cameras                    Jetters

also Computer Hardware & Software



7 Church Road Hatfield, PA 19440  
Phone: 800.422.1844 Fax: 888.883.9380  
Visit our website: [www.libertyfg.com](http://www.libertyfg.com)



COMMERCIAL EQUIPMENT FINANCING  
CALL 800-422-1844

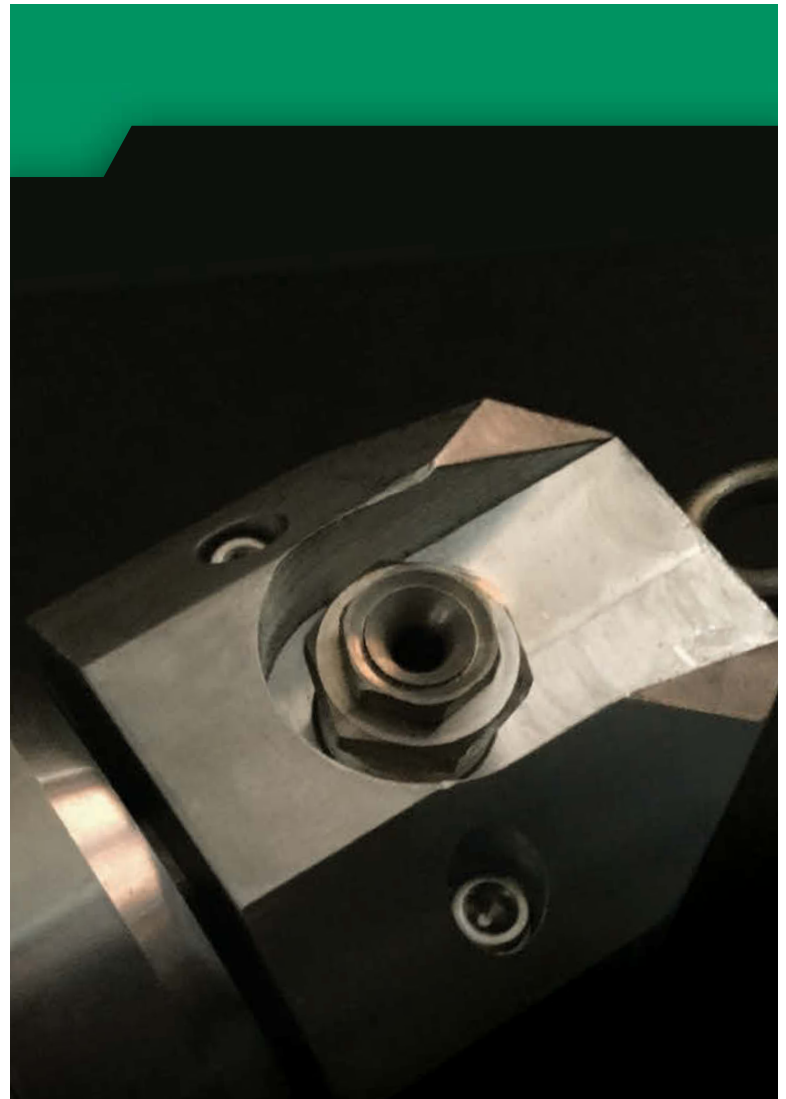

**THIS CHANGES EVERYTHING.**







Luke Laggis  
editor@cleaner.com

# The Evolution of Our Industry

Take advantage of opportunities to grow, improve operations and expand into new services

By Luke Laggis

**W**elcome to February. The 2015 Water & Wastewater Equipment, Treatment & Transport (WWETT) Show is just a few weeks away and we're gearing up for the largest event we've ever staged.

You'll find a preview of the annual Industry Appreciation Party in this issue of *Cleaner*. It's one of the highlights of the WWETT Show, and you should plan to attend if you make the trip to Indy. There will be live music from Cole Swindell and Blackjack Billy, 25-cent tap beer and we're giving away a fully customized Chevy 4x4 pickup truck to celebrate our 35th anniversary.

This issue also features a profile on Downstream Services, a California-based wastewater services company whose ethics and mission are what the WWETT Show is all about.

The company was built from an idealistic concept and a desire to keep our water sources clean and drinkable. Owner Victor Roberts says it all goes back to the Clean Water Act and the importance of maintaining and providing clean water sources for everyone. Having inherited a reverence for the natural world from his father, an author of multiple books on the flora and fauna of Baja California, Roberts isn't shy about sharing his opinion on human responsibility to the environment. He says to continue living on the land, our waterways need to remain clean.

**What was once a small show for septic pumpers has grown to encompass so much more. The show provides opportunities for your company to grow, improve operations and expand into new services.**

Downstream offers pipeline inspection, cleaning and repair, but it has evolved into a larger and more comprehensive role within the industry. The company has taken the next logical step, operating and maintaining municipal and government agency wastewater systems, including instrumentation, pump repair and maintenance.

Evolving, doing more and doing it better is a common thread between Downstream and the WWETT Show. Like the company, the show has evolved. What was once a small show for septic pumpers has grown to encompass so much more. The show provides opportunities for your company to grow, improve operations and expand into new services.

I'm looking forward to another trip to Indy and the opportunity to hear more stories like Downstream's. I enjoy talking to as many of you as possible, getting your feedback and gaining a better understanding of the issues you're facing.

And the WWETT Show is also full of opportunities for your business. From the moment you leave your hotel room to the very end of the night, in the elevator on the way down to the lobby, at breakfast, on the walk to the convention center and all throughout the day, you'll have no problem striking up conversations with your peers. So take advantage: The insight you gain could make all the difference for your business.

There are also plenty of education seminars to help you improve and expand your operations. And of course there are tools and trucks – lots of them. Take it all in and enjoy the show.

If you haven't registered or begun planning your time in Indy, visit WWETT.com for all the information you'll need. It's a great way to help build your business and there's plenty of fun to be had, too.

Enjoy this month's issue. See you in Indy. **c**

**Advanced**  
Work Horse Nozzles

**Is Actively Seeking Dealers In Prime Geographies**

**Contact us**

We'll be doing interviews at the WWETT Show

Featuring the industry leading Near Diamond Hard (NDH™) Conical Ceramic Jets

**Advanced Infrastructure Technologies, LLC**  
Toll Free: **1-844-NOZZLES**  
(1-844-669-9537)  
**www.advancedworld.com**  
Interested Dealers please contact [JP@AdvancedWorld.com](mailto:JP@AdvancedWorld.com)

Advanced Workhorse Nozzles are manufactured in Germany and the USA

Protected Geography Policy · Aggressive Demo Promotions · Personalized Catalogs



# VSI Rentals, LLC.

51 Stone Road Lindenwold, NJ 08021  
888-VAC-UNIT Fax: 856-627-3044

**2014 Peterbilt 348** cab & chassis with a 3,200 U.S. gallon, carbon steel, D.O.T. certified 412 vacuum tank; dump type with full open rear door and a Presvac PVB 750 vacuum-pressure pump.

**6 Available**  
**Price by Request**



**2002 GMC**, dual steer truck mounted, large capacity sweeper with dual sweep gear and catch basin cleaner unit  
**Price by Request**

**2014 Freightliner** truck mounted combination vacuum and jetter units  
**3 Available**  
**Price by Request**



BOOTH  
4162



**2014 Freightliner** truck mounted, industrial wet/dry vacuum loaders with 27" Hg blowers  
**4 Available**  
**Price by Request**

Scan the QR code with your smartphone



**All Units Available For  
Rent or Purchase  
888-VAC-UNIT**

# THIS MARCH, FIND OUT HOW ROOTX IS CHANGING THE GAME.



[www.rootx.com](http://www.rootx.com)





# @Cleaner.com

Visit the site daily for new, exclusive content. Read our blogs, find resources and get the most out of *Cleaner* magazine.



HOT TOPIC

## World Health Organization Talk Slated for WWETT Show

Since the Ebola virus outbreak hit the headlines, many have asked about the potential for various communicable diseases to spread. Attendees at the 2015 Water & Wastewater Equipment, Treatment & Transport Show can hear the latest information on the topic from Dr. Adrianus Vlugman, a senior advisor with the World Health Organization.

[>>>cleaner.com/featured](http://cleaner.com/featured)



MUNICIPAL VS. RESIDENTIAL

## Which Is Right For You?

Are you considering expanding your drain cleaning services? Business owners offer their advice to help you decide if residential work or long-term municipal contracts are best for you. [>>>cleaner.com/featured](http://cleaner.com/featured)



SAFETY FIRST

## Have You Checked Your Gas Detector Lately?

Confined-space entry deaths continue to make headlines. Learn how the proper gas detector could save your life. [>>>cleaner.com/featured](http://cleaner.com/featured)



GOOD DEAL?

## Quality Service Shouldn't Come Cheap

When is it OK to give breaks? It's difficult to know where to draw the line with discounts. If you're haphazardly dishing out price breaks, it's time to slow your roll.

[>>>cleaner.com/featured](http://cleaner.com/featured)

OVERHEARD ONLINE

“If you show them why they need to spend the money to do serious repairs they are more likely to do so. You may still get one out of five people who will go on to get a second or third opinion.”

— Free or Fee: Do You Charge for Video Inspections?

[>>>cleaner.com/featured](http://cleaner.com/featured)



## Emails and Alerts



Visit Cleaner.com and sign up for newsletters and alerts. Get exclusive content delivered right to your inbox and you'll stay in the loop on topics important to you!

## Join the Discussion



Find us on Facebook at [facebook.com/CleanerMag](http://facebook.com/CleanerMag)

or

Twitter at [twitter.com/CleanerMagazine](http://twitter.com/CleanerMagazine)





# Your Guzzler comes with a pit crew



When you buy a Guzzler®, you get more than the toughest, most reliable industrial vacuum truck in the business. You also get the full backing of the Guzzler team – for parts and service, round-the-clock support, training, consulting and industry expertise. Think of us as the pit crew dedicated to taking care of you and your truck. We can even help you expand your business by exploring new markets and applications for your Guzzler truck. With your Guzzler pit crew, the competition can eat your dust.

Guzzler is a registered trademark of Guzzler Manufacturing.  
©2015 All Rights Reserved.

**For a demo or to meet your Guzzler pit crew,  
call 800-627-3171 or visit [www.guzzler.com/pitcrew](http://www.guzzler.com/pitcrew).**



# GROWING WITH THE INDUSTRY

CALIFORNIA CONTRACTOR TARGETS MUNICIPAL WORK AND MOVES BEYOND STANDARD CLEANING SERVICES

**V**ictor and Wilma Roberts' Escondido, Calif.-based firm has nearly doubled in size over the past decade, much of which has been plagued by the worst economy in America since the Great Depression. Clearly, the couple is doing something very right.

The company was built from an idealistic concept and a desire “to make sure our coastal and inland waters remain drinkable.”

It all bounces back, Victor Roberts says, to the Clean Water Act and how important clean water is for the nation as a whole. Having inherited a reverence for the natural world from his father — who wrote books on the flora and fauna of Baja California, and discovered some new species — Roberts isn't shy about sharing his opinion on human responsibility to the environment.

“For us to be able to continue living on the land, our waterways need to remain clean,” he says.

Roberts picked up his dad's mantle and decided to do something about it when he founded Downstream Services.

Downstream offers comprehensive pipeline inspection, cleaning and repair, as it did in the beginning. Since then the company has taken the next logical step in its evolution, now also serving as contractors who operate and maintain municipal and government agency wastewater systems, including instrumentation, pump repair and maintenance.

## EVOLUTION OF A MINDSET

The company launched and built its expertise and reputation executing cleaning contracts for local beach areas in and around Escondido, eventually growing to serve all surrounding beach counties.

“CalTrans [the state's DOT] started issuing contracts to clean their stormwater system and that's really how we got started,” recalls Roberts. “We held that contract for 12 years

Downstream Services co-founders Wilma and Victor Roberts work alongside two of their children, Clark and Loren, who both work as project managers within the Downstream team.







Kenny Lindquist (left) and Javier Cisneros prepare to clean a sewer line using a Camel jet/vac truck made by Super Products.



“We’re always looking for ways to grow our business, both in municipal and government work. We try to combine our efforts all together. It’s basically flexing our muscles, doing things within our field all day long, getting stronger and more efficient at what we do and producing better results.”

Victor Roberts

Downstream Services operator Kenny Lindquist jets a sewer line at the site of a large residential development in the affluent San Diego suburb of Rancho Santa Fe.



for pipes, inlets and sediment disposal. Now all local cities have stormwater compliance divisions in place and are making sure everyone is complying with those local permits and the federal Clean Water Act for discharging water.” Then CalTrans took the work in-house. “As is typical, once agencies understand what needs to be done, they often buy their own equipment and bring the function in-house and only job out the specialized stuff,” he explains.

Ten years ago water-quality improvements were written into city management plans in Downstream’s territory, but they weren’t really monitoring water quality. Stormwater filters and related quality controls weren’t actively installed, but over the years those plans have been implemented. With water shortages becoming more common, cities now have compliance and monitoring in place and closely watch commercial businesses and facilities to make sure they’re treating water before it leaves their properties.

# lansas<sup>®</sup> PRODUCTS

MANUFACTURED BY VANDERLANS AND SONS, INC.



High & Low Pressure Joint Tester



“Smart Box™” Line Acceptance Test Kit



“Super Vac™” Manhole Vacuum Testing



Vacuum Test Plate with Protective Cover



Javier Cisneros (left) and Kenny Lindquist set up near a manhole to clean a sewer line in the Rancho Santa Fe residential development project.



**SPECIALIZE, THEN HONE EXPERTISE**

Downstream has been making an effort to go after these contracts in their area of expertise. “We’re always looking for ways to grow our business, both in municipal and government work. We try to combine our efforts all together. It’s basically flexing our muscles, doing things within our field all day long, getting stronger and more efficient at what we do and producing better results.”

Sticking to this strategy of staying close to its core competencies while slowly branching out into related areas has proven successful. Roberts believes strongly in sticking to what you know but working your tail off to learn a narrow niche deeply.

“The key to our growth is that we remain open to all possibilities within our skill specialties. Agencies are constantly looking for someone to do something better or more efficiently and are always trying out new solutions. So we stay current with new technology because these clients are the forerunners who have the budget from tax dollars to make their operations more effective.”

This dedication to constant improvement has allowed Downstream to build a reputation for safe operations that makes them a hot commodity in their

**profile**

**DOWNSTREAM SERVICES, INC.**

OWNERS: Victor and Wilma Roberts

SERVICE AREA: San Diego, Riverside, Los Angeles, Ventura and Imperial counties; south of San Luis Obispo

YEARS IN BUSINESS: 17

STAFF: 60

WEBSITE: [www.downstreamservices.com](http://www.downstreamservices.com)

service market. This is especially true with government agencies that answer to the public and need to avoid the kind of bad public relations that comes with accidents and injuries.



is announcing the opening of our **NEW Houston, Texas, location.** We’re growing along with you to help you meet the needs of your business.



AR™ Plugs



High Pressure Plugs ~ to 150 PSI



Multi-Size Domeheads™ Front and Back Plugs

*Custom Designs Are Always™ Available*

**VANDERLANS AND SONS, INC.**

California 1-800-452-4902

Atlanta 1-770-509-9309

Chicago 1-800-452-4902

Houston 1-832-804-6932

[www.lansas.com](http://www.lansas.com)

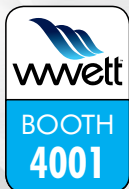





Downstream Services crew and staff pose in front of several of the company's vehicles in Escondido, Calif.

## NO UNNECESSARY RISKS

"The military is mostly concerned with safety and they partner with their contractors," Roberts explains. "Operations are based on safety protocols rather than efficiency or speed. We do not want anyone hurt or killed because we wanted to get a job done quicker, so we first identify safety concerns and what we can do to make sure our people and those around us aren't injured." It's a philosophy the military understands and appreciates.

That's not to say they don't also appreciate speed within sound safety parameters. "We need to make sure we can provide the client with as efficient service as possible under those constraints, so everything we do is scrutinized by our people and the military clients," Roberts says. "It's a completely different way of doing business. In the past we'd ask, 'How can we get this done quicker?' Now safety is always our first protocol."

To make sure it stays that way, Downstream staff are also certified under

## MORE THAN A CLEANING COMPANY

As many Southern California municipalities started taking a more serious approach to wastewater treatment and built or upgraded their facilities, they began having trouble training internal employees for proper operation and maintenance. Soon they began looking for outside help with wastewater management.

Downstream Services, located in Escondido, Calif., started receiving Requests For Proposals from these municipalities for contract operation and maintenance of their wastewater treatment plants. Though they hadn't done this sort of work before, owner Victor Roberts felt their accumulated experience and expertise put the company in a good position to branch out. It was a good call.

"We now come in and act as a turnkey contractor who performs all these functions, up to Grade 5 treatment operations," Roberts says. "It allows us to come in as an organization to do emergency repairs, confined-space entry work and other things they don't need all the time, but when they need them, they're immediate needs."

In this role his staff are responsible for both stormwater and wastewater treatment, requiring them to be certified by the state. "We have our site safety health officer come in once a month for a full day of training to upgrade

technician skills for all the functions we serve and all the certifications they need."

Some of the more significant certifications they hold for both types of work, from a list of about 15 total, include: CWEA Collection System Maintenance Grades 1-4; Hazardous Waste Operations and Emergency Response Standard; State of California Department of Public Health Water Distribution and Treatment; NASSCO PACP, MACP and LACP; and SWPPP Erosion and Sediment Control.

Professional industry organization affiliations include: the California Water Environment Association; California Stormwater Quality Association; California Association of Community Managers; Community Associations Institute; and San Diego Military Advisory Council.

The latter is a connection for networking with other vendors to the military, which Downstream got into initially through contracting at the U.S. Marine headquarters, Camp Pendleton, for CCTV, as well as line cleaning for local bases. Based on its success in the municipal sector, the company then pursued contracts in these bases' wastewater operations and maintenance needs in the southern third of the state.



EM 385, the military's safety bible. All military contractors must adhere to these protocols while working on bases. Downstream works on 15 bases, from Ventura to the Mexican border and the Tijuana Estuary.

### VERSATILITY AND WILLINGNESS

Roberts says it's a pretty even split between municipal and military work for revenue generation. Major types of work include dig-and-replace and trenchless pipeline repair and rehabilitation, both standard and emergency response. CIPP is Downstream's trenchless mode of choice, using the UV-cured Reline America system, which they also use for fiberglass sewer point repairs, generally confined to 10- to 30-foot sections. They've also installed Link-Pipe, a Canadian stainless steel expand-and-lock repair sleeve combined with grout.

Other infrastructure assets such as box culverts and manholes are also tackled as part of pipe repair projects. They'll repair manholes with grout and then follow up with a two-part epoxy lining. "The Navy often has us rebuild manholes where there was such high hydrogen sulfide that it just got eaten away," Roberts says. "It's often more cost-effective for one or two manholes to hand-apply National Coating and Lining epoxy than to spray-apply. We prefer a sprayed-on finish, but out in the middle of nowhere we find hand application works best."

**"We've done it all before and we've got a lot of highly educated people here, including three engineers who identify problems and can offer solutions. We specialize in the gap between the design and the field application."**

Victor Roberts

Roberts believes that the company's willingness to take on any job has been a significant driver of repeat business. "Small jobs are not a problem for us and that's something we're happy to do. It's a large part of our business. We do a lot of emergency response with 24/7 on-call with the military and cities. It's a requirement for the contracts for instrumentation and pump repair. Because we offer such a broad array of services we're equipped to do an entire job in a few days rather than having to corral a bunch of subcontractors. And we can do it at a cost-effective price."

This can-do attitude spurs confidence from clients, who look to Downstream for consultation, as well, Roberts says. "We have pretty much every kind of certification needed to do that. We don't compete with engineers, but if a client has a specific site-oriented problem, we will come out, do an assessment and offer a remedy. That's probably a major advantage we have in our market. We've done it all before and we've got a lot of highly educated people here, including three engineers who identify

problems and can offer solutions. We specialize in the gap between the design and the field application."

### TECHNOLOGY IS KEY

Downstream Services Inc. built its business on anticipating market needs and equipping itself with appropriate vehicles and tools to get the job done.

Roberts began with Camel combination wet-dry vacuum trucks and still runs five of them. A 2006 Isuzu chassis and a 1997 Ford both boast a 5-cubic-yard capacity and can move 65 gpm, while a 2006 Sterling, 2013 International and 2007 International carry 9-yard debris tanks and produce 150 gpm and 2,500 psi. Some have front-mounted reels and are used strictly for cleaning manholes from the street. Others have mid-mount reels on booms that can move 25 feet to the side to reach manholes behind sidewalks



# Downtime Is a Dirty Word

### Every Minute Counts

Getting the job done on time is a big plus — and that goes beyond controlling costs. Meeting schedules keeps customers and crews happy. To pull this off, you need equipment that is ready to go any time and in any weather. That's why leading jetting OEMs and hydroexcavators trust Cat Pumps to get the job done.

### The Perfect Pump for Your Application

Cat Pumps has the best fit for your application, with direct and hydraulic drive models covering flows to 75 gpm and pressures to 10,000 psi. Every pump is built to Cat Pumps industry-recognized high-quality standards.



Model 3560 is rated at 20 gpm at 4000 psi.  
Drive options: direct drive, pulley or gas/diesel engine.

**Every minute counts! Contact us today to see how we can help you get the job done.**

[www.catpumps.com](http://www.catpumps.com) | (763) 780-5440

**CAT  
PUMPS**  
The Pumps with Nine Lives

© Cat Pumps All Rights Reserved. 14505 12/14



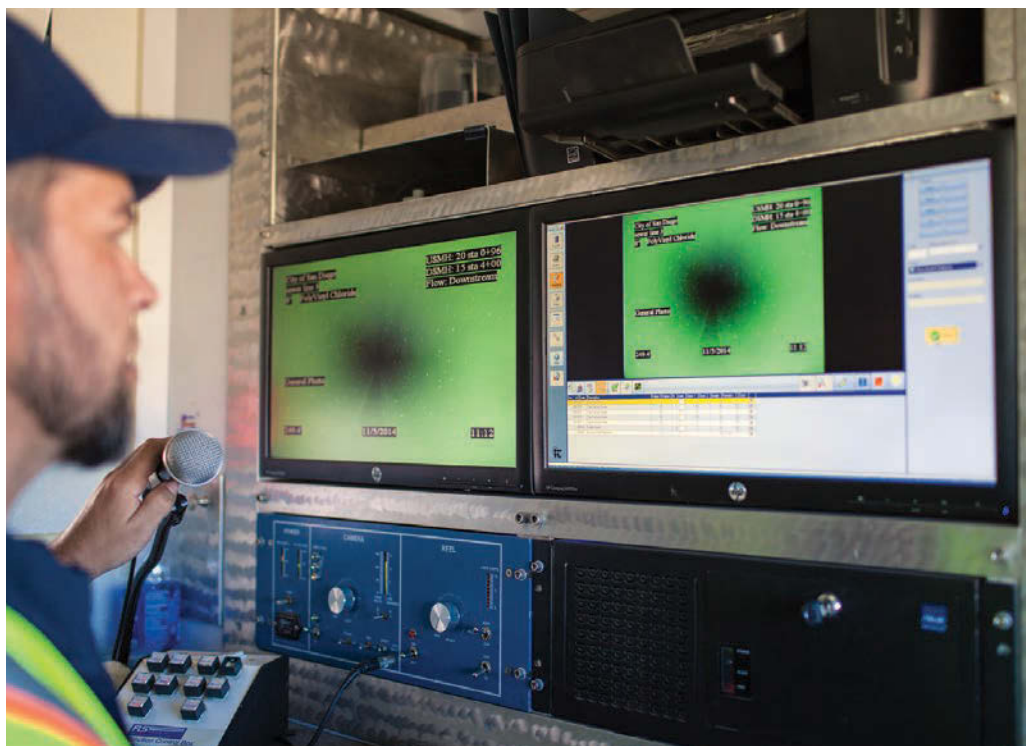

**LEFT:** Burton Smith uses Infrastructure Technologies' ITpipes inspection software to log the inspection notes for a section of pipe at a large residential construction project in a San Diego suburb. The team inspects over 3,000 feet of pipe per day.

**BELOW:** After confirming the route for the next run of pipe, Andrew Wise launches a ProTRAK crawler and TrakSTAR camera (RS Technical Services) to inspect a section of pipe just cleaned by the company's jetting team.



or over fences. These are used most frequently since most of their jobs are in remote, difficult-to-reach locations.

A 750-gallon pump trailer with a pressure washer and hot-water heater is built to handle spill responses. They also rely on an assortment of other pump and crane trucks, including two mini pumper trucks with 750-gallon tanks and a 1998 KW National three-axle flatbed with a 17-ton hydraulic crane, which are suited to a variety of conditions and tasks.

Inspection vans reveal Downstream's preference for equipment from RS Technical Services Inc., which Roberts and his crews rely on for "ease of operation that guarantees consistent productivity. Repairs are easy to do ourselves, but we don't have to do that often because they're reliable and there

## PAST AND FUTURE

Downstream's stable of equipment has evolved with the industry. Before 1995 everything was in upheaval where stormwater was concerned in Southern California. Then a lawsuit between environmentalists and CalTrans forced compliance with the Clean Water Act. After that, Roberts recalls, the stormwater and wastewater treatment industry matured professionally.

"Back then nobody knew what the real problems were or how to solve them. When we bid on a related job in 1997, we were the only bidder. No one knew how to do this or what to do. Even the client didn't really know what they needed to do to become compliant. We thought we could make it work and solve the problem, and being willing to take some risks made us successful. Now there are best practices, guidelines are in place and there is outreach to monitor and fix the problem."

While that's great for the environment, it has also injected competition into Downstream's markets. And in such markets Roberts says the key to success is to have deep pockets and be in it for the long run.

"You're going to lose money until you can build up the capital to buy equipment and pay your people to attract the right ones. Build a reputation for doing things right the first time, and be a hands-on manager. If you can make it in a tough market, you can make it anywhere." **C**

**"We thought we could make it work and solve the problem, and being willing to take some risks made us successful."**

Victor Roberts

aren't many breakdowns unless the equipment is dropped by an operator." Two Ford F350 vans and two 2010 Mercedes Benz Sprinters are outfitted with RS Technical Services inspection cameras and equipment along with Infrastructure Technologies pipeline survey and reporting software.

Downstream prefers to build out its own customized vans, which include a 2001 Isuzu box van that runs an Aries CCTV camera with a lateral launcher and a 2012 Mercedes Benz Sprinter instrumentation and control truck. They also have a 2009 Inuktun Long Range Camera/Sonar System with 5,280 feet of fiber optic cable and 2,000 feet of copper cable.

One of the more unique vehicles in the fleet is a 2014 Ford Transit Connect. The mini inspection system (see December 2014 Money Machines) features a 200-amp alternator that powers a 2,500-watt pure sine inverter from Dimensions Unlimited. Power stored in a 12-volt dry storage battery runs a 5-gallon washdown water supply with pump, front and rear LED traffic advisers, an RST compact portable reel, RST TrakSTAR II camera with TranSTAR steerable transporter and an RST mini mainline controller.

## more info

**Aries Industries, Inc.**  
800/234-7205  
www.ariesindustries.com  
(See ad page 35)

**Infrastructure Technologies - ITpipes**  
505/341-0109  
www.itpipes.com

**Inuktun US, LLC**  
505/994-0702  
www.inuktun.com

**Link-Pipe Inc.**  
800/265-5696  
www.linkpipe.com

**Reline America, Inc.**  
866/998-0808  
www.relineamerica.com

**RS Technical Services, Inc.**  
800/767-1974  
www.rstechserv.com  
(See ad page 55)

**Super Products LLC**  
800/837-9711  
www.superproductsllc.com



# ALLAN J. COLEMAN

## SINCE 1905

Call us today!  
773-728-2400

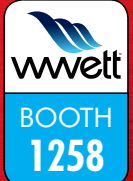

5725 North Ravenswood Avenue • Chicago, IL 60660 • info@allanjcoleman.com • www.allanjcoleman.com

### OLDEST NAME IN THE BUSINESS — Over 100 YEARS OLD

# RIDGID®

## SeeSnake® CS6 Digital Recording Monitor



- Direct-to-USB recording for fast, efficient documentation of inspection jobs
- Water-resistant keypad for direct control of essential camera and monitor functions
  - Daylight viewable display for a crisp, clear in-pipe image
  - SeeSnake HQ Software to edit, archive, and deliver reports via print, DVD, or online
- On-screen keyboard for basic titling and text entry
  - CS6 will dock in the RM-200 Max or operate as a stand alone monitor

## CS65 Digital Reporting Monitor



- One touch recording
- 1 TB internal hard drive
- 6.5" Daylight viewable LCD display
- Water-resistant keyboard
- SeeSnake HQ Software

## SeeSnake® MAX rM200 Camera System



- Next Generation Push Cable and Improved Reel Mechanics
- Ultra Compact Camera Head
- Transport Enhancements
- Docking System
- Self-Leveling Camera Head

## SR-24 Line Locator with Bluetooth® and GPS



- Omnidirectional antennas
- Large display • Built-In GPS
- Bluetooth® technology
- Smartphone/Tablet App
- Can trace any frequency from 10 Hz to 35,000 Hz



## NaviTrack® Scout®

Scout is designed to solve demanding remote transmitter (sonde) locates using multi-directional locating technology.

## SeekTech® SR-20

SeekTech uses omni-directional antennas, guidance arrows and an easy to read mapping display.



Convert your old RIDGID VCR monitor to a USB recorder!



Contact us on how we can do it?

**Authorized SeeSnake Repair Center**

**THE BEST SERVICE AND FAST TURN AROUND!**

**We Have RIDGID Parts!**

**If you buy the best, you are only sorry once!**



# Get Plugged In

AFTERMARKET CONNECTORS • CABLES



ALL cables and connectors are individually inspected and tested before shipment.

REASONABLE PRICES

Seacon/  
Turck



**OceanQuip LLC**  
ORCA TOUGH CABLES

504 738 7833 p/f • jfowler307@aol.com  
www.OceanquipLLC.com

**RYCOM**  
instruments, inc.



## 8873 Locating System

SIMPLE, INEXPENSIVE & IDEAL for locating camera inspection systems, sondes and utilities. The 8873SD is an effective solution for sewer inspection and drain cleaning. Available with 512Hz, 640Hz & 33kHz sonde modes and 82kHz line locating mode, the 8873 is an effective solution for sewer inspection and drain cleaning.

800-851-7347  
www.rycominstruments.com



## Innovation, productivity... even better air quality

New pump unit and accessories highlight NLB's booth #1257

As usual, visitors to the 2015 WWETT show in Indianapolis will find an array of NLB water jet solutions, some being shown for the first time. Highlights include:

- **UltraGreen™ pump unit** – hard-working and convertible, with lower emissions and lower operating costs
- **MiniARM** – adaptable water jet automation that fits through a 30" doorway
- **NLB 286B series lances** – all the features (and pressures) you want, with WJTA color coding
- **Saflex 2001** – portable tube bundle system with a hose reel to enhance jobsites safety

That's not all — we're also featuring a range of convertible pump units and accessories for applications old and new. If you're coming to Indy, we invite you to visit Booth 1257.



UltraGreen™



MiniARM



Saflex 2001



NCG10-286B

NCG15-286BDT

**NLB Corp.** *The Leader in Water Jet Productivity*

29830 Beck Road, Wixom, MI 48393  
MI: (248) 624-5555, IN: (219) 662-6800, NJ: (856) 423-2211,  
LA: (225) 622-1666, TX: (281) 471-7761, CA: (562) 490-3277  
[www.nlbcorp.com](http://www.nlbcorp.com) • e-mail: [nlbmkta@nlbusa.com](mailto:nlbmkta@nlbusa.com)





# On the Rise

Budding country music star Cole Swindell headlining the WWETT Industry Appreciation Party

By Kyle Rogers

**C**ountry music singer/songwriter Cole Swindell is one of Nashville's newest stars, and he plans to make some new fans when he takes the Industry Appreciation Party stage at the Water & Wastewater Equipment, Treatment & Transport Show in February.

The 31-year-old didn't gain prominence — or a record deal for that matter — until his independently released debut single, "Chillin' It," started climbing the charts in 2013. It eventually reached the top spot on the U.S. *Billboard* Hot Country Songs chart, but Swindell knows there's a good chance some people in the audience will be unfamiliar with his material. And he's fine with that.

"Sometimes it's good to get in front of a new crowd that might not know a lot about you," Swindell says. "You get to try to make them a fan by the end of the night. I love challenges like that."

"I'm going to get up there and do what I do. I'm looking forward to it."



Cole Swindell will headline the annual Industry Appreciation Party on Wednesday, Feb. 25, in the Indiana Convention Center's Sagamore Ballroom.

## LESSONS FROM A FELLOW GEORGIAN

Though still a newcomer to the country music scene, Swindell knows what it takes to put on a good show. He went on tour with Luke Bryan in 2014 and prior to that spent a considerable amount of time on the road with him, selling merchandise and writing songs for his fellow fraternity brother from Georgia Southern University as Bryan evolved into a country music star.

"For however long he's out there on stage, he's going to give it all he's got. That's something I've learned," Swindell says. "People spend their hard-earned money and their time to come see us, so you want to give them the best show you can."

He says Bryan was also a big influence on his decision to launch a career in country music in the first place.

"The first time I heard his music was over 10 years ago and I thought he had it," Swindell says. "Even then I was like, 'This guy is going to be huge.' He's from the same part of Georgia but I didn't know him until I had gotten to college and he had already moved to Nashville. Having a guy from just a few minutes from where I grew up writing songs I thought were amazing, that gave me the confidence. 'Hey, if he can do it, maybe I can do this.' It really gave me the confidence to go after it and just focus and work hard."

## FROM SONGWRITING TO STAGE

Swindell says he has been a fan of country music all his life, but he didn't start singing until he was in college and began playing the local bars. After



receiving the merchandise sales gig on Bryan's team after graduation, Swindell started to get into songwriting. He has written Bryan's "Just a Sip," "Beer in the Headlights," "Roller Coaster," "Out Like That," "I'm Hungover," "I'm in Love with the Girl," "Love in a College Town," "Shore Thing," "Shake the Sand" and "The Sand I Brought to the Beach." He's also written songs for Craig Campbell, Thomas Rhett, Scotty McCreery and Florida Georgia Line.

Following the success of "Chillin' It" in 2013, Swindell received a record deal. The first single off his debut album, "Hope You Get Lonely Tonight," which was co-written with Florida Georgia Line, also became a hit. It reached No. 1 on the U.S. *Billboard* Country Airplay chart.

"I didn't even have a record deal when we wrote that song," Swindell says. "I always thought they were going to record it. The second they said it was cool that I recorded it, I told them, 'This will be a single for me one day

"Sometimes it's good to get in front of a new crowd that might not know a lot about you. You get to try to make them a fan by the end of the night. I love challenges like that."

Cole Swindell

if y'all let me record it.' The writing process was fun. They're good friends of mine and I'm so proud of all their success. It's cool to get to have a little bit of each other's success."

With his first two singles each topping the charts, Swindell says there's pressure to continue the trend but he doesn't mind it.

"You come out with a No. 1 single and then you have to follow that up and you get fortunate and have two No. 1's. Then you have to follow that up. But I think that's a good thing, you know? The streak's not going to go on forever and I'm realistic, but we're going to try. I want to give the fans and radio the best songs I can, and I think [reaching No. 1] is a good goal. If you don't reach the No. 1 spot at least you gave it a shot."

## THE COMING YEAR

His debut album, two straight No. 1 singles and a nomination in the Best New Artist of the Year category at the Country Music Association Awards have made the past year quite the start to Swindell's country music career. For the coming year he's already scheduled to join Jason Aldean for the second leg of the "Burn It Down" tour beginning in February.

"Jason is another huge influence and there's another Georgia boy so, man, I couldn't have picked anyone better to go on tour with. That's going to be an awesome way to start off 2015," Swindell says.

That same month he will be taking a break from the tour to play the more intimate Sagamore Ballroom venue at the Indiana Convention Center for



## THIS PARTY AIN'T NO ONE-TRICK PONY

Cole Swindell may be the big draw at the WWETT Show's Industry Appreciation Party on Wednesday, Feb. 25, but he won't be the only highlight that night.

It all begins at 4 p.m. when the doors open to the party's new venue, the Sagamore Ballroom on the second floor of the Indiana Convention Center. The 25-cent tap beers start flowing at 5 p.m. and the evening's first musical act, Blackjack Billy, will take the stage an hour later. The four-member Nashville-based band is best known for their 2013 debut single "The Booze Cruise."

The winner of the WWETT truck giveaway will be announced shortly after Blackjack Billy's set, at approximately 7 p.m. All registered WWETT attendees are automatically entered into the contest for the tricked-out 2014 Chevrolet Silverado 1500 4x4 Extended Cab, or alternately \$35,000 cash, being given away in celebration of the show's 35th anniversary. Twelve contestants will be randomly selected beforehand and invited to participate in the event that will determine a winner.

The party will conclude with a performance from Swindell, who is set to take the stage at 7:30 p.m.

WWETT attendees. Swindell says his hope is that he can add a little "pleasure" to the "business" that will undoubtedly be a primary focus for many trade show attendees that week.

"They could've picked a lot of people [to play the Industry Appreciation Party] and for me to get to do it, that's cool," says Swindell. "It's a different setting [than a tour stop] and there will be business folks in there, but I want to let them have a little fun that night. That's going to be my goal — make sure they have a good time." **C**



**WATER & WASTEWATER EQUIPMENT, TREATMENT & TRANSPORT SHOW**

EDUCATION DAY: Feb. 23, 2015 | EXHIBITS OPEN: Feb. 24 - 26, 2015 | Indiana Convention Center

[WWW.WWETT.COM](http://WWW.WWETT.COM)





# Quality Used Trucks

## Available for Immediate Delivery

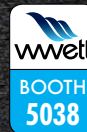

**2014 Kenworth T300 with 2014 Predator Vacuum System | Truck ID #14148**

- Paccar PX-9 engine
- Fuller FRO 11210C 10 speed transmission
- 350 horsepower
- 2,488 miles and 60.9 hours
- GVWR: 36,000; front 16,000; rear 20,000
- RFL 100 Wittig pump
- 3,000 gallon tank capacity
- NVE valve upgrade
- 4" vacuum piping



**2007 Mack with 2012 Guzzler CL Truck ID #56434**

- 246,335 miles with 10,698 engine hours
- 425 horsepower
- 60 bag filtration with air cannon
- Single mode filtration
- 14" SS liquid level float ball shutoff
- 5300 CFM 28" vacuum blower
- Blower discharge temperature gauge
- Omsi transfer case



**2009 Int. 7600 with 2010 Vector HXX | Truck ID #72091**

- Cat C-13 engine
- Fuller FRO-15210C transmission
- Mileage: 109,287 Hours: 4,612
- 430 horsepower
- GVWR: 66,000; front 20,000; rear 46,000
- 20 GPM Cat pump
- 8702 Hibon blower
- 12 yard debris box

©2014 FS Solutions Group

Interested? Call John Stafford, FS Solutions Used Equipment Sales Manager (815) 341-3512 for pricing or visit [fssolutionsgroup.com](http://fssolutionsgroup.com) for a complete listing of used equipment



## T&T Tools, Inc.

Fax: 800.521.3260  
Email: [sales@mightyprobe.com](mailto:sales@mightyprobe.com)

**800.521.6893**  
**[www.MightyProbe.com](http://www.MightyProbe.com)**

Call for a FREE Catalog



Call for a FREE Catalog

### HOOKS...

- > Several different styles of heat-treated hooks are available
- > Top Poppers are great to open manhole covers
- > The Handy Hooks allow two handed use



### PROBES...

- > Insulated, standard, and specialty soil probes
- > Metal shaft sizes: 3/8" round, 3/8" hex, or 7/16" hex
- > Replaceable tips are threaded on and hardened
- > A "slide" allows the handle to pound the shaft into the ground





# Pressure Washers, Replacement Engines, Pumps, Parts & Accessories

## 15J84 - Electric Jetter Package



- Commercial Industrial Grade Motor 2.0 HP - 115 Volt Single Phase 18 Amp
- GFCI Protected - Hand Carry - General Triplex Plunger Pump - 2.0GPM - 1500PSI - UPS shippable - 2+5+5 Year Manufacturer's Warranty - Jetter/Pulse Valve On Demand (Not Shown) - Ball Valve - 150' x 1/4" 4000 PSI Red Jetter Hose - 50' x 1/8" 4000 PSI Red Jetter Hose - 4 Jetter Nozzles

**\$999**

## 15J27 - Jetter Base Model



- Honda GX 200
- Portable - Roll Cage Protected
- General Triplex Pump - 2.8GPM
- 3200PSI - 3+5+5 Manufacturers Warranty - Jetter/Pulse Valve On Demand
- 150' x 3/8" Capacity Hose Reel, Ball Valve, & Jetter Nozzle

Jetter Hose Sold Separately

**\$1,099**

## 15J91 - Electric Jetter Package



- Commercial Industrial Grade Motor 2.0 HP - 115 Volt Single Phase 18 Amp - GFCI Protected
- Portable with Rollcage
- General Triplex Plunger Pump - 2.0GPM
- 1500PSI - 2+5+5 Year Manufacturer's Warranty - Jetter/Pulse Valve On Demand - Ball Valve - Assembled in USA - 150' x 3/16" 4000 PSI Red Jetter Hose - 50' x 1/8" 4000 PSI Red Jetter Hose - 4 Jetter Nozzles

**\$1,399**

## 15J41 - Jetter Package



- Honda GX 390 - Portable
- Roll Cage Protected - EZ Series General Triplex Pump - 4.0GPM
- 4200PSI - 3+5+5 Manufacturer's Warranty - Jetter/Pulse Valve on Demand
- 250' x 3/8" Capacity M10-5 Hose Reel, Ball Valve - 200' Jetter Hose
- 4 Jetter Nozzle Pack

Attachment Kits Sold Separately

**\$1,479**

## 17HJ39 - Jetter Package



- Honda GX 630 Electric Start - 15 Gallon Fuel Tank - Roll Cage Protected - V-Belt Drive - Triplex Plunger Pump
- 5.5GPM - 3500PSI - 3+5+ Lifetime Manufacturer's Warranty - Jetter/Pulse Valve on Demand, 350' x 3/8" Capacity Hose Reel, Ball Valve & 4 Jetter Nozzles Included. 300' Jetter Hose - 50' Hose, Trigger Gun, Wand, Chemical Injector, & QC Nozzles

**\$4,599**

## 16T52 - 2 Wheel Road Ready Commercial Jetter Trailer



- Electric Rewind High Capacity, 500' x 3/8" or 350' x 1/2" Hose Reel
- 200 Gallon Tank with Float Valve - Poly Tool Box - Lights, Front Jack with Wheel, Safety Chains, Aluminum Fenders - Commercial High Pressure Jetter - Vanguard 18 HP Electric Start Engine - V-Belt Drive - Trailer Mounted Skid - 15 Gallon Fuel Tank - Tank Feed Capable - General Triplex Plunger Pump - 5.5GPM - 3500PSI - Pump Mounted Jetter Pulse Valve - Foot Valve with 8' jumper Hoses - 3 Jetter Nozzles, Penetrator, Flusher & De-Greaser / De-Icer - 1 Year Manufacturer's Warranty

Jetter Hose & Attachment Kits Sold Separately

**\$7,999**

WaterCannon.com

**30**  
YEARS OF SERVICE

1.800.333.WASH (9274)



Industry Trained Staff available from 8:30 a.m. to 7:00 p.m. weekdays E.S.T.

Water Cannon, Un contacto en Espanol: llama al: 1.800.917.9274

Orlando | Phoenix | Minneapolis | Hattiesburg | Melbourne | Toronto | Bogota  
International: 1-321-800-5763

Water Cannon  
is proud to be a  
**MWBE**



# 1975 FLOW EXPO 40 YEARS 2015

SATURDAY, MARCH 21ST, 2015, 9AM - 4PM -  
LONG BEACH CONVENTION CENTER



*Come Help Us Celebrate*



**40 Years**

*We're Giving the Gifts!*

From humble beginning's in 1975 the Flow Expo has grown into the largest PHC Trade Show in the Western United States.

PLUMBING  
HVAC/R  
BACKFLOW  
JETTING  
FIRE SUPPRESSION  
TRENCHLESS  
TRUCKS  
INSPECTIONS  
GREASE HANDLING  
UTILITY LOCATING  
DRAIN CLEANING  
VEHICLE TRACKING  
WATER DAMAGE  
SERVICE & REPAIR  
REMODELING AND MORE...

*It's our 40th Birthday  
and you get the gifts...*

Raffles will be held throughout the day to celebrate.

Over 200 booths representing more than 400 brands with the newest in tools, services and training to make your job easier and your company more productive.

Everyone knows no matter what kind of Contractor or Technician you are...

The **FLOW EXPO** is the ONE.

**Pre-Register Online for complementary admission**

**FLOWEXPOUSA.COM**

Flow Expo presented by PHCC-GLAA Off: 323.913.7340

# Rely on Reelcraft



BOOTH  
**1373**



Photo courtesy of Vactor, a subsidiary of Federal Signal Corporation

Special paint colors and finishes ▶



**Did you know... Reelcraft can build to your specs?**



### Reelcraft's Capabilities

- ✓ Built to your exact needs
- ✓ Very few size and weight constraints
- ✓ Special finishes/paint options
- ✓ Various drive types
- ✓ Wide range of pressures
- ✓ No minimum quantities

To learn more visit us at [www.reelcraft.com/custom](http://www.reelcraft.com/custom)



Multiple spools ▲



▶ Turn-key systems

**Made in USA**

**REELCRAFT**®

[www.reelcraft.com](http://www.reelcraft.com) | 800-444-3134



  
wwett  
BOOTH #4110

SAVE ON: CABLES • ACCESSORIES • MUCH MORE!

# WWETT SALE

BIGGEST SALE OF THE YEAR!

15% OFF CABLES\*

**RIDGID**

*Electric Sel*<sup>®</sup>

**General**

 **DRAINCABLES**  
*direct*

**CAN'T MAKE THE SHOW? NO WORRIES!**  
800.421.4580 • [draincables.com](http://draincables.com)

\* Sale Ends 03/27/15 or while supplies last. Sale prices may not be combined with quantity discounts or special pricing. Sectional cables excluded. Discount percentage may vary by product. Attendance to the show not required promotional pricing.



## ABOUT THE AUTHOR

Judy Kneiszel is a small-business owner and business writer in De Pere, Wis.

# The Threat Within

Fraud isn't something that only takes place at huge corporations; it could be going on right under your nose

By Judy Kneiszel

**T**om Mattison is a 77-year-old business owner who thrives on giving. The military veteran volunteers his time helping his community and would give the shirt off his back to help a fellow Marine. What he doesn't appreciate, however, is someone taking ... from him ... behind his back, which is what was happening for years.

Mattison is the owner of Tom Mattison Septic Service in Midway Park, just outside of Jacksonville, N.C. He's been pumping, installing and inspecting septic systems and clearing drainlines in eastern North Carolina for five decades. He was not aware, however, that for at least six years his bank account was being drained while he was out jetting lines.

The story Mattison tells is as old as commerce itself. A trusted employee wrongfully takes something that belongs to his or her employer. Only when it happens in one's own company, however, does a person really sit up and take notice. Mattison, who says his office manager skimmed \$18,000 or more from his company, doesn't want you to wait until it happens to you. He wants other pumpers and cleaners to learn from his experience.

## HOW IT HAPPENED

Mattison says an employee who worked in the office at Tom Mattison Septic for seven years was paying for manicures, plants, train tickets and other goodies for herself with the company credit card.

"I work out in the field," Mattison says. "I can't be in the office answering the telephone and doing all the paperwork. I need a trusted employee in the office and I thought I could trust her."

After a second office worker was hired last year, the longtime office manager refused to share her computer passwords, which raised a red flag. Mattison became even more uneasy when the new person quit without warning, so he invited his daughter, a mortgage banker, to go with him to the credit union one Saturday morning and have a look at the business accounts. The following Monday morning Mattison and his daughter were waiting for the office manager at the door with a box of her personal belongings. She left without denying any wrongdoing, Mattison says.

**"I work out in the field. I can't be in the office answering the telephone and doing all the paperwork. I need a trusted employee in the office and I thought I could trust her."**

Tom Mattison

Over the next several weeks Mattison, his daughter and the second office employee (who was persuaded to return to work) carefully went through the accounts compiling stacks of evidence to share with a county sheriff's department detective. The former office manager has been charged with felony larceny by an employee and the case is pending.

What's disheartening for Mattison is that a person he had known and trusted for years committed this crime.

"I treated her like one of my daughters," he says. "This came as a total shock to me."

Mattison says he doesn't expect to get his money back but he hopes his former employee gets some jail time, sending a message to others that they won't get away with stealing from employers.

## TIPS FOR AVOIDING EMPLOYEE FRAUD

Office procedures have changed at Tom Mattison Septic because of the embezzlement incident. All passwords have been changed and Mattison knows the new ones. Here are a few other steps to help any business protect hard-earned revenue:

**Limit the number of different credit cards issued in your company's name.** Credit card offers are hard to refuse, and saying yes to them can benefit a company by racking up airline miles and other rewards for using multiple credit cards. But having multiple cards makes keeping track of purchases more difficult.

**Don't entrust any one employee to all money-handling duties.** Assign one employee to authorize purchases and another to pay the bills. More eyes on invoices means less of a chance for stealing.





**Be observant.** Make a mental note of changes in an employee's lifestyle. Things like a divorce or a serious illness in the family may make a person feel desperate for money and tempted to skim from company funds. Often embezzlers tell themselves it's "a loan" they'll pay back, but then it snowballs out of control.

Also look for signs that an employee has a gambling problem or a drug addiction. Observing doesn't mean accusing, of course. But if someone or something seems a little off, keep an eye on the books. Even small things can signal trouble. For example, if you know how much an employee earns and wonder how they can afford to go out for pricey lunches and drink Starbucks coffees every day, something might be amiss.

#### OTHER WAYS TO PROTECT YOUR COMPANY

- Dump the stamp or the computer signature. Mattison says he signs all checks personally now rather than having a signature stamp lying around or signing electronically.
- Do random checks of bank and credit card statements and question even small purchases you don't recognize. Thieves often test the waters with \$5 and \$10 purchases and then up the ante if no one catches on.
- Consider bonding employees who will be making purchases or paying bills. A fidelity bond is employee-dishonesty insurance covering a business in case of employee theft or fraud. If a bonded employee embezzles, the payout received by the employer can be used to recoup some of the loss and to take legal action. Rates vary depending on how many employees are covered and amount of coverage.
- Don't sign checks without seeing the corresponding invoice. And avoid signing blank checks.
- Consider conducting criminal and credit checks on job candidates. Make sure this is legal in your state, however. Some states have outlawed this practice. And always check references before hiring someone. Often what a former employer won't say speaks louder than what they will say.
- Insist that employees use their vacation time. Schemes often reveal themselves when the employee involved is not there to keep up the ruse.
- Work with your bankers. You may be able to provide them with a list of approved vendors so they can notify you if checks are written to anyone else.

- Look at statements from vendors. If you notice that all invoices from a single vendor are in numerical order without skipping any numbers, you are their ONLY customer, you are writing checks to a fictitious vendor or they have a strange accounting system they should explain to you. **C**

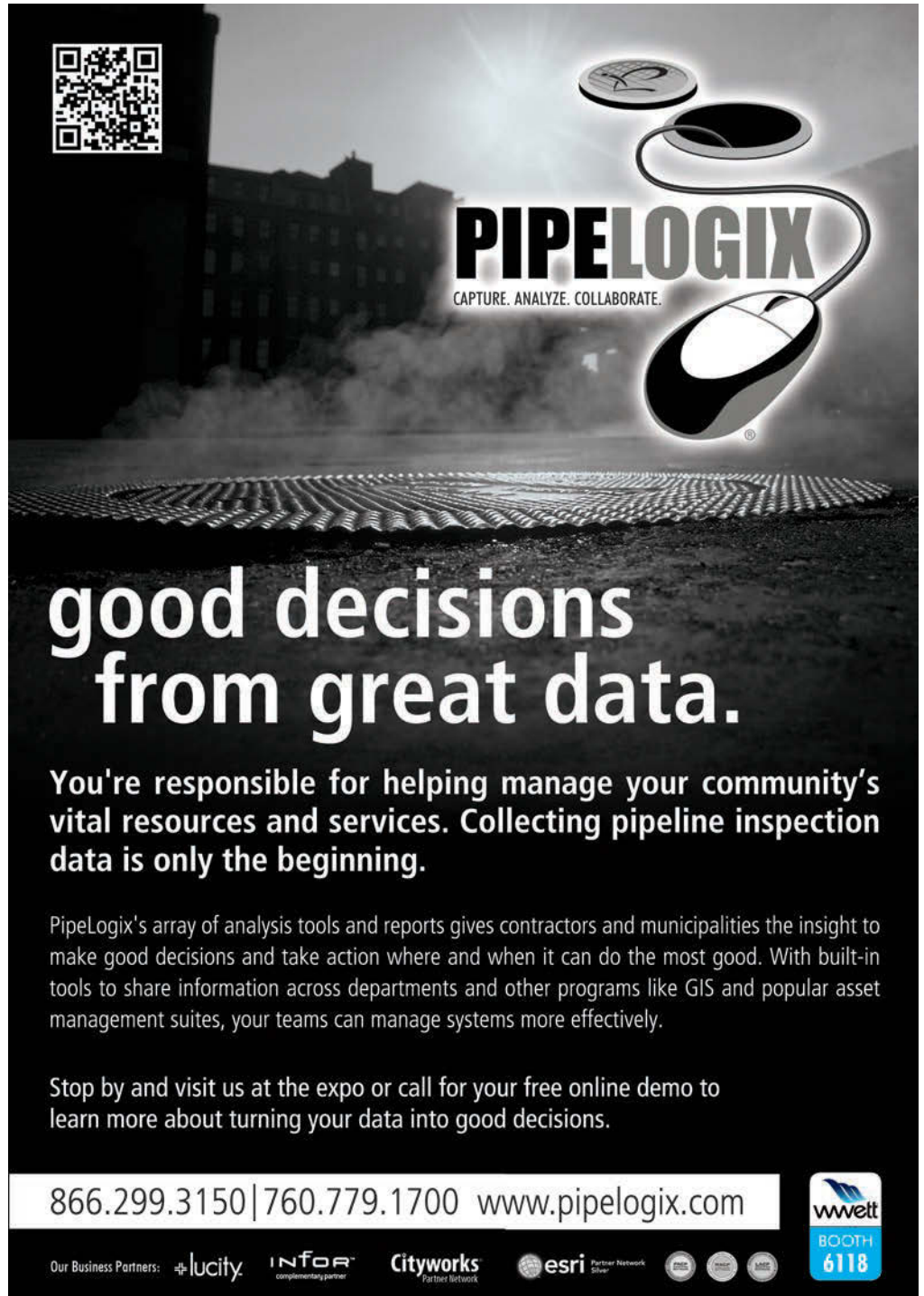

**PIPELOGIX**  
CAPTURE. ANALYZE. COLLABORATE.







# good decisions from great data.

**You're responsible for helping manage your community's vital resources and services. Collecting pipeline inspection data is only the beginning.**

PipeLogix's array of analysis tools and reports gives contractors and municipalities the insight to make good decisions and take action where and when it can do the most good. With built-in tools to share information across departments and other programs like GIS and popular asset management suites, your teams can manage systems more effectively.

**Stop by and visit us at the expo or call for your free online demo to learn more about turning your data into good decisions.**

866.299.3150 | 760.779.1700 [www.pipelogix.com](http://www.pipelogix.com)

Our Business Partners:      

 **BOOTH 6118**



collaborate · understand · deliver

# Demand More from Your Data.



It's what our industry has been waiting for—the power to share inspection results in real-time via the cloud, scale for big data, visualize system-wide condition with GIS, plan/track field operations via Google Maps, and generate high-level deliverables like heat maps, budgetary proposals and 3D system models.



sold & supported by:

[www.pipelineanalytics.com](http://www.pipelineanalytics.com) • (877) 626-8386



real-time insight

## Freeze-Up Problems? Get The ARCTIC BLASTER

THAWING DEVICE

SIMPLE — SAFE — QUICK — CONVENIENT — ECONOMICAL

Have freeze-up problems? We've got the simple, low cost **ARCTIC BLASTER THAWING DEVICE** that thaws pipes above and below ground. The perfect winter tool for: rental shops, plumbers, battery operators, septic tank truckers, farmers, feedlot operators, native and remote housing, mobile home parks, electrical contractors, and more. Use on plastic, copper or ABS. Perfect for roof drains.



**ORDER IT TODAY!**

It will probably pay for itself the 1<sup>st</sup> day you need it.

**AUNTY SEPTIC SAYS...**

"Invest in this little money-maker for excellent winter profits! Give your income a big boost!"



**ARCTIC BLASTERS INC.**

SUNDRE, ALBERTA

403.638.3934 • Fax: 403.638.3734 • [www.arcticblaster.com](http://www.arcticblaster.com)

## RHINO



- 8 lb. and 12 lb. (4140) ASTM A148 cast steel head breaks frozen covers free easily. Serrated edge strengthens pick-end and eliminates possibility of tool becoming bottlenecked in the cover.
- Combination sledge hammer and pick/pry bar. Two tools in one enables a worker to carry only one piece of equipment into the street
- Tapered saw-tooth pick fits 5/8" or larger drain holes and most pick slots.
- Top quality handle constructed of fiberglass.
- "Mary A" is patented.

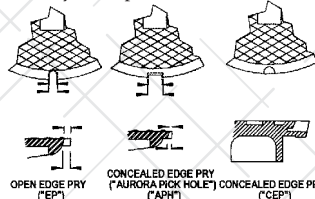

Distributed by:  
**DOUG MEADOWS COMPANY, LLC**  
1.800.588.3684  
Fax (325) 695-7954

Web site: [www.dougmeadows.com](http://www.dougmeadows.com)





# predator or prey



**WOLVERINE**  
CUTTING SYSTEM

Are your budgets getting eaten up due to long set-up times? Have you been a victim of low productivity due to poor cutter performance? Now you can attack the challenge of lateral reinstatement cutting with the Wolverine Cutting System.

Hunt down and reinstate your laterals rapidly and accurately with this self-propelled cutter. The Wolverine provides a feature-rich, powerful alternative to your current cutting equipment.

**Are you predator or prey when it comes to pipeline rehabilitation?  
Call Aries today and start tracking your success.**



[www.ariesindustries.com](http://www.ariesindustries.com) | (800) 234-7205

**ARIES**  
INDUSTRIES, INC.

See what you're missing.



PROFILE



BY MARIAN BOND

PHOTOGRAPHY BY BRAD STAUFFER

# SMALL COMPANY, BIG SYSTEMS

COMBINED EXPERIENCE AND PLANNED STRATEGY HELP BUSINESS PARTNERS

CLIMB THE RANKS OF TWIN CITIES CLEANING CONTRACTORS



<< Previous page: The staff of One Hour Rooter in Maple Grove, Minn., includes (from left) Ben Gihl, Ray Jones, Trevor Whalen, co-owner Justin Stevens, Kari Knock, co-owner Ben Theis and Nick Aase.

# A

fter a little over two years in business and a humble start with one person in a rented office, the owners of One Hour Rooter in the Twin Cities now find themselves near the top of their market.

Justin Stevens and Ben Theis went to school together, became plumbers together and eventually opened the business together. They knew the local market and both believed they had an opportunity to build a successful drain cleaning and inspection business.

“We had a plan which included jetting and TV inspection,” Stevens says. “When we started, we leased an office with one bay and a three-car garage. We paid cash for all our equipment and vehicles as we did not want a big ‘overhead monster’ to deal with. There

**“We urge our technicians to be personable, from how they present themselves at the customer’s door, putting on shoe covers, to informing the customer every step of the way, reviewing our pricing and getting the job done.”**

Justin Stevens

are pros and cons to that type of operation, but it is how we chose to proceed. When we had cash we purchased equipment. We didn’t pay ourselves a lot of money. We put cash back into the business.”

By mid-2014 they had nine employees, six technicians and six colorful green service vans on the road.

### PLAN OF ACTION

The duo first spread the word about One Hour Rooter through online marketing, but that wasn’t quite enough. They networked with some larger plumbing companies that wanted their drain cleaning services and were able to put together a referral program and start subcontracting. The company always uses their own pricing and billing, however, and their logo appears on all equipment. Nevertheless, they aren’t out to steal customers and are careful not to undercut anyone. “No bait and switch,” says Stevens.

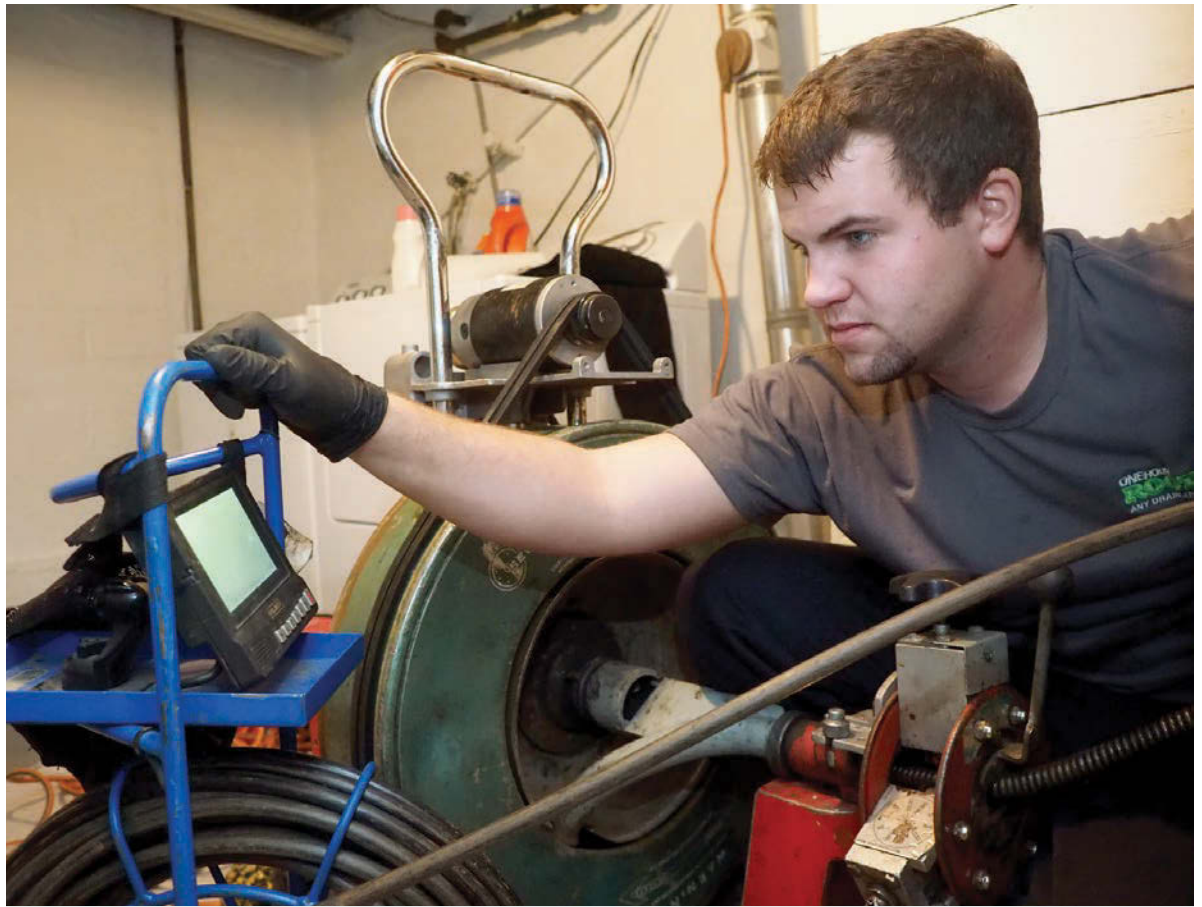

One Hour Rooter’s Ben Gihl inspects a residential sewer line with an Electric Eel CCTV camera while out on a cleaning call in North St. Paul, Minn.

profile

### ONE HOUR ROOTER, SERVING MINNEAPOLIS AND ST. PAUL, MINN.

OWNERS: Justin Stevens and Ben Theis

OPENED: 2012

SERVICES: Drain cleaning, plumbing

EMPLOYEES: 9

WEBSITE: [www.onehourrooter.com](http://www.onehourrooter.com)



“These associations for us were crucial in the beginning. We were having to figure out what marketing worked for us. We did a lot of direct mail, ran ads in different magazines — all kinds of guerrilla marketing — parking our trucks in obvious places, driving in parades.”

One Hour Rooter was soon well enough established that they were no longer relying on subcontracting. Stevens estimates it’s just 1 to 2 percent of total sales today.

“I would look at our success as a mix between professionalism both in the office, in the field and with our technicians,” Stevens says. “We train once a week; we are a small company with big company systems, and that comes from our varied experience. We urge our technicians to be personable, from how they present themselves at the customer’s door, putting on shoe covers, to informing the customer every step of the way, reviewing our pricing and getting the job done. We want people to communicate and to have respect for the property and the person they are serving.

“We are almost a completely paperless operation,” he continues. “Everything is tracked. All invoicing is set in place and we can access everything remotely.



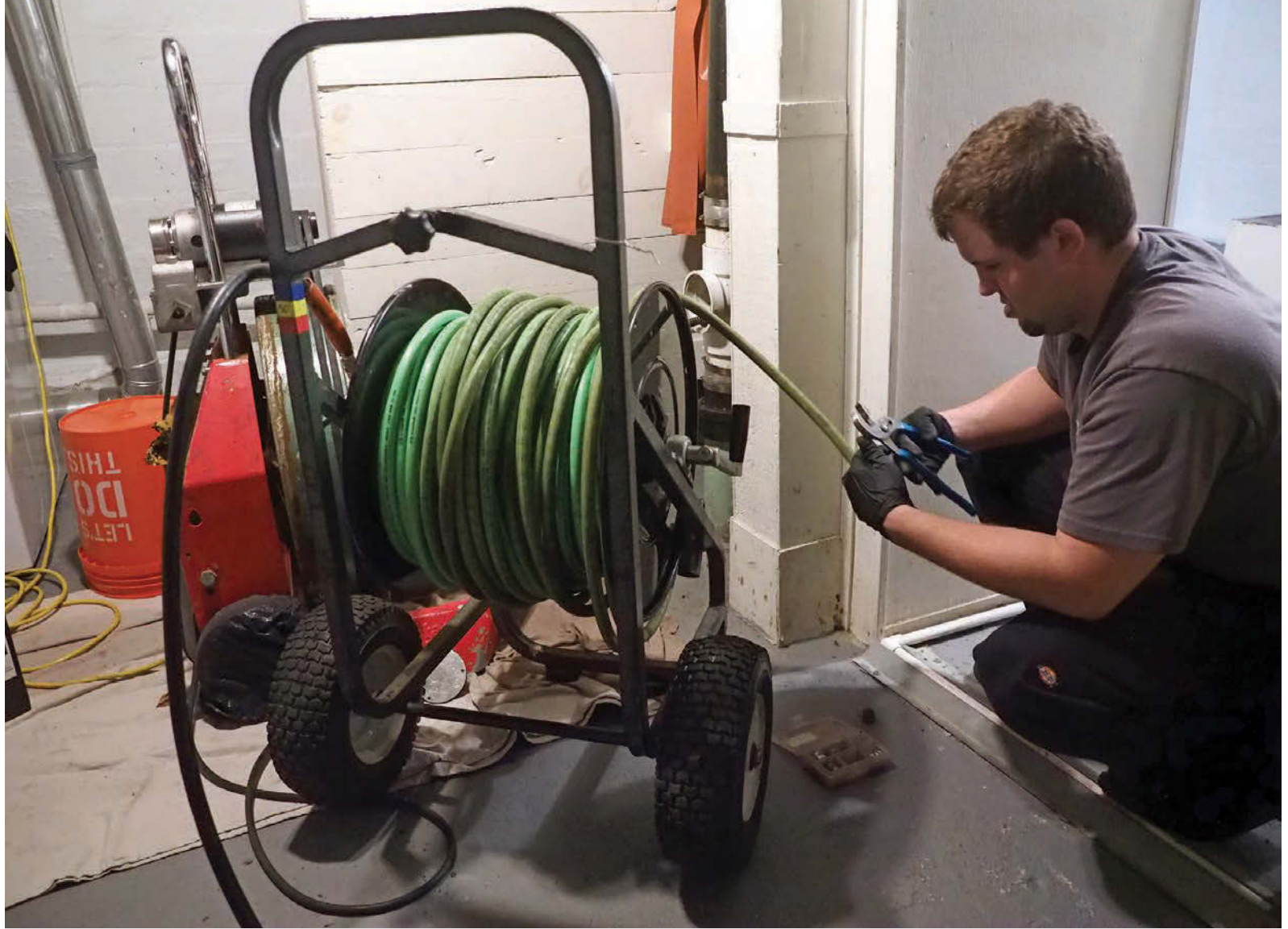

Ben Gihl attaches a new nozzle to the jetter hose, which is connected to a truck-mounted MyTana MV80 jetter.

I can be in Arizona and pull up a customer invoice on my cellphone. We track everything, from marketing, to calls, average sales per call. We designed all our systems in-house.

“We know we are on the right track as we are averaging 15 to 20 service calls a day; we have repeat customers. If a business owner or homeowner

Sometimes payment may be a little slower with commercial customers whereas the homeowner is quick to pay the bill.

“For us the residential side is less stressful,” he says. “There is a lot of satisfaction in helping out a resident. There is a lot of room for us to grow on the residential as well as commercial side of things.”

## TOOLS AND TECHNICIANS

To facilitate continued growth the company added services, but rather than jump into pipe lining or bursting they took a different route. Realizing that many customers search for a plumbing company when minor stoppages occur, they expanded to include some plumbing services to attract those customers.

There are no plans to handle sewer replacements or rehabilitation, but long-term plans include pumping services and eventually some municipal work for smaller utilities.

Drain cleaning remains the company’s core focus, and their biggest weapon in the fight against clogged lines is a MyTana MV80 jetter (8 gpm/4,000 psi) mounted in a Chevrolet Express full-size van. They also use drain cleaning machines from Spartan Tool, along with eCAM-ACE cameras from Electric Eel and RIDGID Navitrak Scout locators.

Stevens estimates that a fully equipped service van will carry close to \$10,000 worth of equipment.

Technicians, who take their vans home at the end of the day, take pride in their wheels and their appearance. Uniforms are furnished but the individual

**“We want the technicians to realize there are different situations out on the job and be able to adjust to the circumstances. Some things do not have meaning until you have the actual experience or know to anticipate a challenge.”**

Ben Theis

is unhappy, we give them back their money. Our office help is great with customers. We give a call back after every service call.”

One Hour Rooter is a 24/7 operation. Their customer base is 75 percent residential and 25 percent light commercial, the latter being made up primarily of restaurants and strip malls. Stevens says they would be happy to see the commercial side expand but there are some differences between the two.



One Hour Rooter co-owner Ben Theis helps Ben Gihl clean a drainline with a Spartan Tool Sewer Raider cable machine.

is responsible for daily care. Each driver has a car wash pass, so vehicles always look good.

Finding the right technician is a challenge, Theis says. Before settling on a candidate they will interview several, and then it takes a couple months to actually see if the new hire is a good fit. New employees ride along with a technician until all procedures are thoroughly understood, and the company pays a training wage until the technician is up to speed.

Theis tries to share his knowledge with the technicians when there is an equipment failure or issue so that if they are in the field and there is a problem, the technician will have some hands-on experience and can possibly solve the problem there on the spot.

## FROM DITCHES TO RICHES

As a young college student, Justin Stevens supported himself as a plumber, going on to get his journeyman license and then a master plumbing license. He worked for several large companies and learned the business from top to bottom, then put on his entrepreneurial hat and came to the conclusion it was time for him and partner Ben Theis to strike out on their own.

In a rented office initially, Stevens was the sole technician, getting the operation going and doing all the fieldwork himself until he could hire a technician and bring on his trusted partner.

Stevens discovered plumbing much earlier when he needed a job and a relative who operated a large plumbing company was looking for a helper. Grateful for the work, he signed on, but as he was digging trenches and doing the dirty work he told himself there was no way he would ever spend his life as a plumber. Then he began seeing the fruits of all his labors and taking pride in the things he could accomplish.

Looking back to those times, he now is grateful for the opportunity he had and how fortunate he was that someone was willing to take in a completely inexperienced person to learn a skill and gain so much knowledge.

"Plumbing was a temporary thing for me back then," Stevens recalls. "But then I began to see the finished product. Once I had the understanding of the industry, I knew it was the right thing for me."



# You Can't Buy A Better Reel. But You Can Get One FREE.

Come to the Hannay Booth #5027 at this year's WWETT Show and register to win a Hannay portable hose reel on wheels.

**Hannay Reels are uniquely designed to make your job easier.**

- Reels can be customized to meet your exact specifications.
- Heavy-gauge steel frames, exclusive one-piece axle assembly, special bearing design and our original "ribbed" discs can stand up to the most demanding jobs.
- Accessible swivel joints allow for easy installation and maintenance.

**So make sure you stop and register at our booth, and you could walk away a winner with this brand new Hannay reel!**

For more information, call us at **877-467-3357** or visit us online at **[hannay.com](http://hannay.com)**

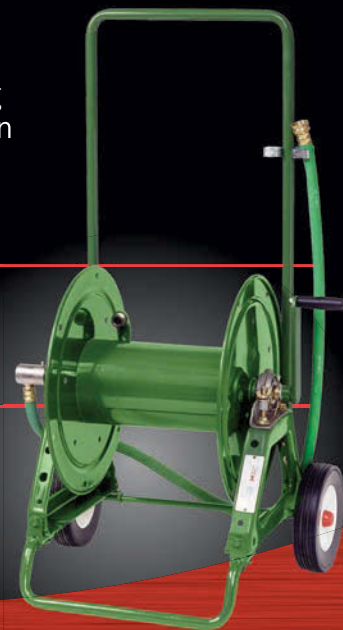

 **Hannay Reels®**  
The reel leader.





Ben Gihl unloads equipment while setting up for a residential drain cleaning job.

“We want the technicians to realize there are different situations out on the job and be able to adjust to the circumstances,” Theis says. “Some things do not have meaning until you have the actual experience or know to anticipate a challenge. In some cases, I may need to caution about providing better care of an expensive piece of equipment.”

He says that each morning they review the jobs for the day and decide where they are likely to need a camera and where the jet-mounted van will be going.

**“As owners we have a lot of behind-the-scenes responsibilities. Sometimes you just need to shut down and go see your kids. Get away. We also enjoy giving the employees this little break as well.”**

Ben Theis

“We use the jetter several times each day,” Theis says. “We can be pretty flexible with this and can get to a job when needed.”

“At our meeting each morning we make sure everyone is on the same page. Then at our Tuesday morning meeting we address all the safety issues, sales or other concerns the techs may have. It’s important for us to listen to people, and we try to give them what they want.”

In 2013 and 2014, as a special event and reward, One Hour Rooter took calls for a two-hour morning period on a Thursday and then the entire crew went by bus to see the Minnesota Twins play at Target Field. The following Friday was also a day off.

“As owners we have a lot of behind-the-scenes responsibilities,” Theis says. “Sometimes you just need to shut down and go see your kids. Get away. We also enjoy giving the employees this little break as well.”

### AND THEY GREW

This describes himself as the more mechanical of the two, which Stevens says creates a perfect balance.

“I would say my management style is probably a little more intense than Ben’s,” Stevens says. “Our employees sometimes find him easier to talk with. But that depends on what’s going on, and we have worked together for so long we more or less know the dynamics and it makes things hum along pretty well. Neither of us could run this company on our own and enjoy the success we are seeing.”

He says they have put all their energy into building the customer base and following the business plan.

Stevens notes opening their own business didn’t bring any big surprises because they had seen so much in their previous jobs. They knew what to expect.

“The greatest reward on a daily basis is watching this company grow,” Stevens says. “Seeing our equipment on the road and our employees. Knowing these people are counting on us for their job. I like that we have been successful. That really makes me feel good.” **e**

**Don't be a good operator,  
BE A GREAT ONE!**

**vwelt** BOOTH 5016

The Standard of the Industry

**CUES MUNICIPAL GROUT SCHOOL**

Please join us for the CUES Municipal Grout School!  
We will be offering (8) PDH credits from CIGMAT.  
For more information, please visit the  
TECHNICAL SCHOOL web page at  
[www.cuesinc.com](http://www.cuesinc.com).  
WHERE: Orlando, Florida  
WHEN: April 9 - 10, 2015  
EMAIL: [smcdaniel@cuesinc.com](mailto:smcdaniel@cuesinc.com)  
800.327.7791, x-345

**CUES**  
TECHNICAL SCHOOLS

### more info

**Electric Eel, Mfg.**  
800/833-1212  
[www.electriceel.com](http://www.electriceel.com)  
(See ad page 74)

**MyTana Mfg. Company, Inc.**  
800/328-8170  
[www.mytana.com](http://www.mytana.com)  
(See ad page 83)

**RIDGID**  
800/769-7743  
[www.ridgid.com](http://www.ridgid.com)

**Spartan Tool, LLC**  
800/435-3866  
[www.spartantool.com](http://www.spartantool.com)  
(See ad page 96)



# Why Buy Harben?

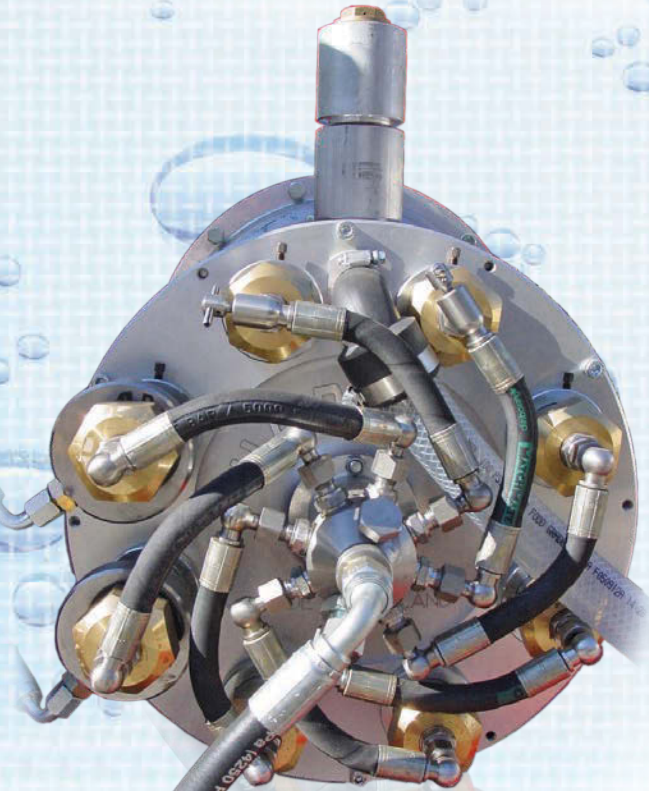

- /// Advanced Radial Piston Design
- /// Exclusive Five Year Warranty
- /// TRUE Run Dry Capability
- /// Low Maintenance Costs
- /// Quiet & Smooth
- /// No Interacting Parts to Wear
- /// Brackish & Saltwater Pumping Capability
- /// Harben Has History – 43 Years in The Business



Experience the Harben difference

**TRAILERS**

**SKIDS**

**TRUCKS**

**ENCLOSURES**

Call today to schedule a demonstration. **1-800-327-5387**

**HARBEN**<sup>®</sup>  
**High Pressure Water Technology**

[www.harben.com](http://www.harben.com)

Scan the code  
below with your  
smart phone  
application





# Taking you places you've never been before.



Record wirelessly to Cell Phone or iPad



Ratech now adds a wi-fi interface to its arsenal of innovation. Safe, secure, and delivering on the promise of quality and durability industry professionals demand, Ratech now introduces a wi-fi interface to the growing list of ways you can view and record CCTV video pipeline inspections. Just one more example of how for over 33 years, Ratech Electronics has been at the forefront in the development, manufacturing and servicing of CCTV systems and equipment.

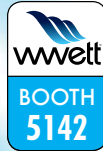

Staying ahead of your customer's needs.

**NEW**



Mini Crawler with Pan n' Tilt

Interchangeable Heads



Inspector PC-Xi<sup>®</sup>  
(Also works with tablets)



Optional Steerable Gooseneck

Pan n' Tilt Push Camera

(Includes Reel and Remote Control)



Elite SD<sup>®</sup>



We also carry  
Ultra Micro<sup>®</sup> Cameras



For more information on these or other products call toll free: 1-800-461-9200 or 905-660-7072 or visit [ratech-electronics.com](http://ratech-electronics.com)



Upload your inspection videos to **YouTube** Ask us HOW?

Follow us on Twitter @RatechCam



WHY DO LESS WHEN YOU CAN **ACHIEVE** SO MUCH MORE?

**The Picote Chains** Easy & efficient cleaning of cast iron drains & sewers

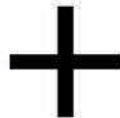

Locate your reseller at [picotesolutions.com](http://picotesolutions.com) or call 219 440 1404 for further information.  
Visit us and our resellers at the WWETT 2015 in Indianapolis, Feb. 24 - 26, 2015.





# SOUTHLAND TOOL MFG. INC.

*Building Innovative Tools for Municipalities*



## SOLUTIONS TO SEWER CLEANING



Manhole Tools • Debris Baskets • Vac-Traps • Root Saws • Calcium Cutters • Sewer Rods • Handy Clams • Nozzle Extensions • Deep Vac Tube Holder • Grabbers  
Claws and Hooks • Diamond Tap Cutters • Fiberglass Poles • Hydraulic Cutters • Top Manhole Rollers • Sewer Spoons • Continuous Rod • Carbide Saws



An ISO 9001-2008  
Certified Company



1430 N. Hundley St • Anaheim, CA 92806 • ph: 714.632.8198 • fax: 714.632.8228 • [www.SouthlandTool.com](http://www.SouthlandTool.com)



# VARCO

LIQUID WASTE HOSE & ACCESSORIES

PROUDLY MADE IN THE USA

## ITS HERE!! – FINALLY JETTER HOSE AT A CRAZY LOW PRICE MADE RIGHT HERE IN THE USA!

**VARCO Branded and MADE IN THE USA;**  
**We get it for cheaper, so we can sell it for cheaper.**

- Lateral line hose has become the standard for the septic industry.
- Polyether-urethane cover provides exceptional cut, abrasion and fungus resistance.
- Sizes from 1/8" up to 1", Working pressures up to 4800psi.



**Comes on Plastic Reel- For No Extra Charge! No Cardboard to Get Wet!**  
Smaller sizes and lengths do not come on reel - check with your customer service rep for details.

### NEW VARCO SEWERFLEX SEWER HOSE

DESCRIPTION	3/4"	1"
Varco Sewerflex Orange 2500psi	\$2.48 ft	\$3.10 ft
Varco Sewerflex Blue 3000psi	\$2.45 ft	\$2.89 ft



3/4" AND UP FOR VAC TRUCKS



1/8" AND UP FOR JETTERS

### NEW VARCO JETTERFLEX



### NEW VARCO SEWERFLEX



### JETTER NOZZLE KITS

Free tip cleaner included with each nozzle kit. Individual nozzles available for each type and size.

FROM \$13100

YOU WILL NEED TO KNOW YOUR GPM AND PSI TO ORDER THESE NOZZLES- THEY ARE CUSTOM DRILLED

### NEW VARCO JETTERFLEX LATERAL LINE / JETTER HOSE

4000 psi rated • Safety Green - Pressure Tested • Precoupled assemblies MXM pipe thread fittings

	50 ft	75 ft	100 ft	150 ft	200 ft	250 ft	300 ft	400 ft	500 ft	600 ft
1/8"	\$15.28	\$21.25	\$26.38	\$37.49	\$48.60	\$56.74	\$66.88	\$87.15	\$107.45	-
3/16"	\$26.12	\$33.17	\$41.35	\$55.25	\$69.95	\$84.68	\$99.38	\$128.82	\$158.25	\$187.69
1/4"	\$29.85	-	\$55.85	\$81.82	\$107.77	\$126.38	\$150.52	\$198.77	\$247.02	\$295.28
3/8"	\$62.08	\$91.28	\$105.54	\$151.12	\$215.06	\$259.57	\$304.05	\$382.09	\$469.43	\$556.77
1/2"	-	-	\$186.69	-	\$353.97	-	\$505.85	\$660.02	\$815.97	\$972.66

**ORDER TOLL FREE 866-872-1224**

**SHOP 24 HOURS A DAY 7 DAYS A WEEK**

**ONLINE AT WWW.VARCOPUMPER.COM**



SOURCE KEY  
**02C15**

### HIGH PRESSURE PUMPS



HDP MC high pressure pump. The most compact 1500 HP unit available. 100 GPM @ 22,000 PSI.

Hammelmann high pressure pumps are built to operate at the continuous maximum duty stated in the performance parameters.

**Hammelmann Corporation**  
Toll-free: 1-800-783-4935  
mail@hammelmann.com

### TANK AND VESSEL CLEANING



3D Tank Cleaners available for rent or purchase with pressures up to 26,000 PSI and flows exceeding 150 GPM.

Hammelmann is dedicated to supplying contractors with the tools they need for all kinds of different applications.

436 Southpointe Drive  
Miamisburg, Ohio 45342  
www.hammelmann.com

### OUR RENTAL FLEET



Our fleet of rental pumps range from 5,000 PSI to 50,000 PSI with flows to 70 GPM.

**Hammelmann Corp. Houston**  
Toll-free: 1-866-317-8677  
bill.obriant@hammelmann.com  
402 HWY 146 South  
La Porte, Texas 77571



# HAMMELMANN®



# SCOOTER

VIDEO  
INSPECTION SYSTEMS

20843 Santa Lucia • Tehachapi, CA 93561 • Fax: 661.822.8917

**"Simplify your life!"**

SCOOTERS ARE EASY TO USE, TOUGH AND DEPENDABLE.  
**DON'T LEAVE THE SHOP WITHOUT ONE.**



**Tired Of Squinting  
At A Tiny Monitor?**

Get An  
Attaché  
With A **15" LED**  
Hi-Def  
Monitor

The new Scooter Attaché 1+  
now includes a giant 15" LED  
hi definition color monitor as  
well as a high quality SD/DVR  
recorder, and has the capacity  
to operate other camera  
systems too!



**SPECIAL  
PACKAGE**

**Scooter 200**

Color, Attaché SD/DVR, Locator Transmitter, Voice Over

**Complete Package**

**\$4,995**

**800.772.6165**  
[www.tvinspection.com](http://www.tvinspection.com)





# No Time for Downtime

Reliability of Ramjet jetting trucks improves efficiency and makes customers happy

By Ken Wysocky

In the municipal and industrial drain cleaning business, equipment downtime is a profit and productivity killer. It disrupts job schedules, increases business expenses and perhaps worst of all, irritates customers. It could even motivate them to find a new contractor.

Or so Gene Glassburner, the owner of Performance Pipeline Technologies (PPT) in Huntington Beach, Calif., has heard. He's not all that familiar with the concept of downtime because his company owns five Ramjet V8015 waterjetting trucks, built by Vactor Manufacturing. He says the machines are as reliable as they are efficient.

"We run these trucks every day for eight to 10 hours a day, and the longest downtime we've ever had is one full day," says Glassburner, who purchased his first Ramjet jetter truck in 2003. "And when it comes to maintenance and minor repairs, they're very easy to work on."

**"We run these trucks every day for eight to 10 hours a day, and the longest downtime we've ever had is one full day. And when it comes to maintenance and minor repairs, they're very easy to work on."**

Gene Glassburner

Competition is strong in the area served by PPT, roughly a 200-mile radius around Huntington Beach, located south of Los Angeles. The company's services include cleaning and televising sanitary sewers and stormwater lines; spot repairs of pipelines using a UV-light-cured relining system made by Cosmic Engineering GmbH; industrial pipeline cleaning; and utility locating. The bottom line: If PPT falters on the job, there's no shortage of contractors to take its place, points out Jason Gomez, a superintendent and project manager for PPT.

"For most of the work we do, there's plenty of other contractors out there who also do it," he notes. "So by minimizing downtime, we don't lose customers who need work to get done quickly and dependably and who might look somewhere else if we can't get the job done. Plus, if the truck's not out in the field, we're not making money."

The Ramjets are mounted on International, Chevrolet and Sterling truck chassis. PPT uses the jetter trucks primarily for municipal work, mostly to clean 8- or 12-inch-diameter pipes for either routine maintenance programs



Performance Pipeline Technologies jetter operator Dan Schuler cleans a sewer line with one of the company's five Ramjet V8015 waterjetting trucks from Vactor Manufacturing.

**money machines**

- OWNER:** Performance Pipeline Technologies, Huntington Beach, Calif.
- EQUIPMENT:** Five Ramjet V8015 waterjetting trucks, made by Vactor Manufacturing
- FUNCTION:** Primarily for cleaning municipal mainline sanitary sewers and stormwater lines
- FEATURES:** A 1,500-gallon water tank; rear-mounted hose reel with 800 feet of 1-inch-diameter hose; single-piston pump that generates flow up to 80 gpm and maximum pressure of 2,000 psi
- COST:** About \$185,000

or emergency blockages. Each truck features a 1,500-gallon water tank and a Vactor single-piston hydraulic pump that delivers flow of up to 80 gpm and maximum pressure of 2,000 psi.

Four of the trucks feature a rear-mounted hose reel that articulates 270 degrees and holds 800 feet of 1-inch-diameter hose. The fifth truck also carries a rear hose reel that holds 800 feet of 1-inch line, but it's mounted inside a 14-foot box body. Three of the trucks also include a smaller hose reel — also mounted in back — that holds 250 feet of 1/2-inch-diameter hose, used for cleaning residential lateral lines.



Performance Pipeline Technologies uses the Ramjet jetter trucks primarily for municipal work. Each truck features a 1,500-gallon water tank and a Vactor single-piston hydraulic pump that delivers flow up to 80 gpm and maximum pressure of 2,000 psi.



“That lateral-cleaning capability makes us more productive because it saves us from having to bring out another crew just to clean out a lateral,” he says.

The articulating reel is especially helpful because it keeps operators out of traffic and the truck doesn't have to be parked facing a certain direction to work, Gomez says. He also lauds the diesel engines in three of the newer trucks. The engines idle at a much lower level, which enables the company to perform noise-restricted jobs in residential areas during nighttime.

“The flow-control feature also is great,” Gomez says, noting that some water jettors will operate only at one flow rate. “We can run it at 40, 65 or 80 gpm, instead of, say, just 80 gpm the whole time. Sometimes when you clean a line in the street it creates a vacuum or pressure in a home and you see water agitating in a toilet. If that happens, we can run at lower gpm.”

Another beneficial feature is a hose-vibrator system operators can activate by shutting off an accumulator valve. It's helpful when cleaning lines set at a grade — sometimes up to 15 degrees, he says.

“It vibrates the hose via a pulsating pump, which helps it travel farther than a standard hose,” he explains. “Without it, we would have to go to the next manhole and work in reverse, which runs the risk of flooding out a house.”

The Ramjets really shine when they tackle tough jobs like calcium removal and cast iron pipe tuberculation. The groundwater level is high in PPT's coastal service area, so calcium deposits commonly form at joints between pipe sections.

“Our claim to fame is calcium removal ... sometimes we see 8-inch pipes that've been reduced to 3 inches in diameter by calcium deposits from the hard water around here,” Gomez explains. “In a worst-case scenario, every joint in a 300-foot line might be calcified. And if pipes crack it can be even worse.

“But with the Ramjets we can typically do 300 feet of pipe in an eight-hour shift using mechanical nozzles and high water volume at high pressure, usually 80 gpm at 1,800 psi,” he adds. “Sometimes it takes a little longer, like when we're asked to restore a pipe to 95 percent of its original capacity for relining.”

PPT uses nozzles made by KEG Technologies Inc., NozzTeq Inc., StoneAge and Sewer Equipment. In addition, PPT owns three Vactor 2100 Plus PD combination vacuum trucks with hydroexcavating



## FLEXIBILITY.

### Max out your capabilities with our complete CIPP solution:

- Quality felt liners that twist, stretch and accommodate up to 90° bends
- Compact equipment for laterals, verticals and hard-to-reach pipes
- Supplies, liners and resins made by the world's leading manufacturers
- Custom solutions with 4-6" transitions for any liner length or complexity
- High performance resins that are economical and ecologically-friendly

**MAXLINER**



276.656.1225



[maxlinerusa.com](http://maxlinerusa.com)

CONTINUED >>



# NEW! Prevent Toilet Blowout with The Bulldog® Antiblast!



Specifically engineered to **prevent blowing toilets** when cleaning sewer lines near residential areas by reducing pressure in the pipe.

- Excellent streak-free, all around cleaning
- Low maintenance, and compatible with recycled water
- Proven design
- Pipe range cleaning 6" - 24"
- Scientifically engineered and tested
- For use in all types of pipe



**CALL 1 877 ENZUSA1  
FOR A DEALER NEAR YOU**



[www.enzusainc.com](http://www.enzusainc.com)



1585 Beverly Ct., Unit 115 | Aurora, IL 60502

capability and eight camera trucks outfitted by CUES Inc. and RS Technical Services Inc.

Glassburner says the Ramjet jetter trucks have been instrumental in growing his business, established in 2003. And in the end their reliability is invaluable, both professionally and personally.

"We're on call for a lot of cities," he notes, explaining the professional aspect. "If they have stoppages and we're on call and sewage is running down a street, we need to be out there within the hour. And on some jobs, if we don't finish projects in time, we might have to pay anywhere from \$250 to \$1,000 a day in liquidated-damage fees. That's not an issue for us, thanks to the Ramjets."

As for the personal aspect, Glassburner's explanation is simple: "Having these machines allows me to sleep better at night." **c**

**Special  
Pricing**

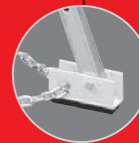

**800-325-3730**  
[milwaukeerubber.com](http://milwaukeerubber.com)



# CUES, THE TOTAL SOLUTION FOR PIPELINE INSPECTION AND CONDITION ASSESSMENT

CUES is the world's leading manufacturer of closed circuit television video (CCTV) inspection, pipe rehabilitation, pipe profiling equipment and condition assessment / decision support software for sanitary and storm sewers.

Systems include digital side scanning cameras, grouting equipment for sewer line and lateral pipe joints, lateral inspection equipment, lateral reinstatement cutters, and laser and sonar pipe profiling. With the largest support staff and inventory in the industry, CUES will maximize your return on investment as a trusted business partner.



Contact CUES for a discussion & demonstration!  
 800.327.7791  
[www.cuesinc.com](http://www.cuesinc.com)  
[salesinfo@cuesinc.com](mailto:salesinfo@cuesinc.com)



MINI SYSTEMS



GRANITE Xp  
 Asset Inspection / Decision Support Software



LATERAL & MAINLINE INSPECTION



LATERAL REINSTATEMENT CUTTERS



TRANSPORTERS



CAMERAS



LASER & SONAR PIPE PROFILERS



PORTABLE SYSTEMS





# Pipeline Cleaning & Maintenance Equipment *for*



## JETTERS & JET VACS

### Penetrators

- 1/4"-15° .....\$24.00
- 3/8"-15° .....\$33.00
- 1/2"-25° .....\$46.00
- 1/2"-25°LT .....\$49.00
- 3/4"-12° .....\$59.00
- 3/4"-12°LT .....\$69.00
- 1"-12° .....\$72.00
- 1"-12°LT .....\$84.00



### Aluminum Sand

- 3/4"-24° .....\$141.00
- 1"-17°/24° .....\$156.00
- 1"-24° .....\$141.00



### Swivel Joints

- T-M® Style
- 90° or Straight, 6000 psi
- 3/4" & 1" .....\$198.00
- 1-1/4" .....\$210.00
- 1-1/2" .....\$560.00
- 2" .....\$807.00

### Aluminum Grease

- 3/4" or 1"-17° .....\$125.00

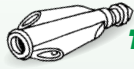

### Truder

- 3/4" or 1"-17° .....\$350.00



### Shark

- 1" .....\$495.00
- 1" Big Shark .....\$610.00

### Stainless Steel Nozzles

- 1/8" .....\$37.00
- 1/4" .....\$41.00
- 3/8" .....\$45.00
- 1/2" .....\$57.00
- 3/4" .....\$91.00
- 1" .....\$116.00

### Ball Valves

- Dyna Quip® Style
- 3000 psi
- 1" .....\$227.00

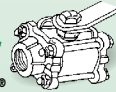

### Radial Bullet

- 3/4"-18° or 35° .....\$50.00
- 3/4"-18°/24° .....\$53.00
- 1"-18° or 30° .....\$69.00
- 1"-15° or 30° .....\$69.00
- 1-1/4"-18 or 35° .....\$85.00

### Steel Sand

- 1"-12° .....\$73.00

### NEW Storm/Culvert Floor Cleaner Nozzles

### Parker & Piranha Jetter Hose

- 1/8"- 1-1/4"

### Saw Blades

- 4" - 18"
- NEW Chain Root Cutters
- 4"-48", All Stainless Steel, No Lubrication



### Root Cutter Assemblies

- Skid Mounted
- w/flat blades .....\$1175.00
- w/concave blades .....\$1198.00
- w/spiral blades .....\$118.00
- Donut Mounted
- w/flat blades .....\$1125.00
- w/concave blades .....\$1160.00
- w/spiral blades .....\$1160.00
- Lateral Mounted
- w/flat blades .....\$1020.00
- w/concave blades .....\$1075.00
- Assemblies come with one ea. of 6, 8, 10 and 12" blades, saw blades, hub, skids, etc.

### Sewer Hose Guides

- TigerTail™ Style
- 3" x 36° .....\$38.00
- 2" x 36° .....\$38.00
- with 24' rope



### Clamps

- Power Clamps
- 8" .....\$13.00
- 3"-6" available
- King Clamps
- 8" .....\$29.75
- 4"-6" available
- Bandlock® Clamps
- 8" .....\$24.00
- 3"-6" available
- Quick Clamps
- 8" .....\$26.50
- 3"-6" available

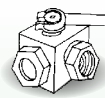

### Hycon® Valves

- 2 & 3-way Ball Valves
- 5000 psi
- 1/2" 2-way .....\$65.00
- 3/4" 2-way .....\$89.00
- 1" 2-way .....\$119.00
- 1-1/4" 2-way .....\$226.00
- 4500 psi
- 3/8" 3-way .....\$115.00
- 1/2" 3-way .....\$160.00
- 3/4" 3-way .....\$180.00
- 1" 3-way .....\$190.00
- 1-1/4" 3-way .....\$440.00
- 2" 3-way .....\$690.00



- HD Washdown Gun
- 25 gpm @ 850 psi
- 1/2" Inlet .....\$185.00

Pipe/Sewer Plugs • Hose Reels • Aluminum Intake Tubes  
Kanaflex™/Rubber Debris Hose • Full Line Of Warthog Nozzles

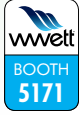

Toll Free: 800-365-6583  
[www.cloverleaftool.com](http://www.cloverleaftool.com)

Full Catalog Online with Prices

SARASOTA, FLORIDA • PHONE: 941-739-0707 • FAX: 941-739-0001



MANY OTHER STYLES, SHAPES & SIZES AVAILABLE

CALL FOR OUR COMPLETE CATALOG WITH PRICES

# Pulsar 2000 Line Tracer

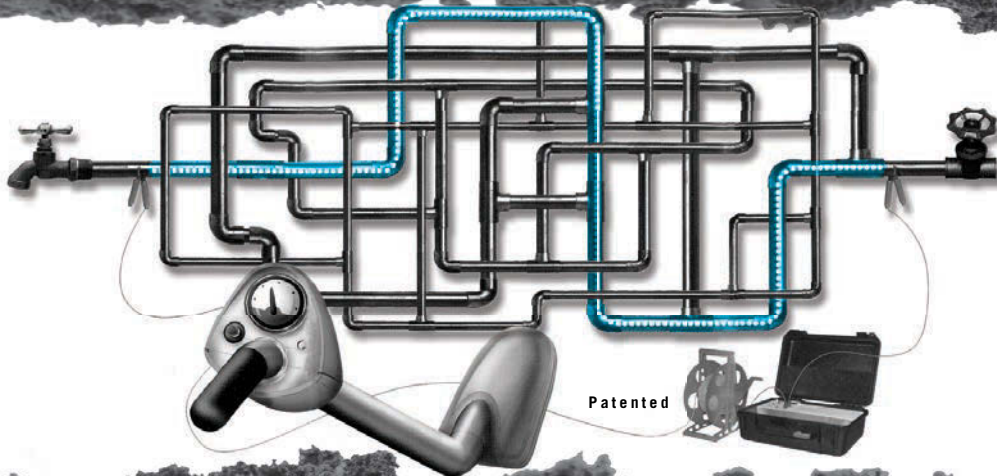

Locate Lines  
Locate Water Leaks  
Training Video

*It's a jumble out there.*

[www.Pulsar2000.com](http://www.Pulsar2000.com)  
DISTRIBUTORS WANTED



The Pulsar 2000 line tracer is designed primarily to locate metallic pipes. The Pulsar 2000 is a directional line tracer. Connect the Pulsar's powerful and unique transmitter to your target pipe and locate only that pipe. Locating can be accomplished under floors, in walls and in ceilings. The Pulsar 2000 does not require grounding.

**Leak detection personnel...** The Pulsar 2000 is a must have locator. Now you can quickly identify the pipe location, thereby reducing the search area of the leak.

**100% satisfaction guarantee...** We are so sure that you will see the time saving benefit of the Pulsar 2000, we will let you return it for a full refund if you are not satisfied. If

you want to learn more about the Pulsar 2000 and our leak locating equipment, please call 1-888-752-5463 or e-mail [jsmll@aol.com](mailto:jsmll@aol.com) for a free demonstration video or CD and references of satisfied customers.

We have been using the Pulsar 2000 along with the XL2 fluid detector and Geophones since January 1989 in our leak locating business. Our leak locates are **accurate 95% of the time**, but I can honestly say, the line we trace is always there. Our equipment is user-friendly and requires very little training, as you will see on the video. Purchase the Pulsar 2000 line tracer, XL2 fluid detector and Geophones, and start locating leaks immediately.



**UltraGreen™ from NLB**

# **Introducing the cleanest water jet power you can buy (or rent)**



**UltraGreen™**

## **EPA compliance and lower operating costs**

Talk about a win-win: new UltraGreen™ water jet pump units from NLB cut emissions to near-zero, and typical users can **save over \$12,000 a year**.

UltraGreen units have Tier 4-compliant engines that meet the new EPA standards, reducing NOx and particulate matter by 90% or more. And since they use far less fuel, your operating costs are also dramatically lower.

Tier 4 certification isn't required everywhere yet, but

it will be. Get out in front with an UltraGreen water jet unit, available for sale or rent at all six NLB regional branches. Ask about our trade-in programs for older NLB units, too.

NLB already has over 350 low-emission units in the field, reducing costs while enhancing our environment. Give your business a competitive edge — call 800-441-5059 today.

 **NLB Corp.** *The Leader in Water Jet Productivity*

29830 Beck Road, Wixom, MI 48393  
MI: (248) 624-5555, IN: (219) 662-6800, NJ: (856) 423-2211,  
LA: (225) 622-1666, TX: (281) 471-7761, CA: (562) 490-3277  
[www.nlbcorp.com](http://www.nlbcorp.com) • e-mail: [nlbmktg@nlbusa.com](mailto:nlbmktg@nlbusa.com)





# Leading with Safety

The Vector® 2100 Plus was engineered with input from contractors and municipal workers. That's why we put the hose reel in front – so you can pull forward onto your worksite, with no need to back into traffic. And on the job, the truck is between you and oncoming vehicles. In other words, we lead with safety.

But that's not the only reason you want the Vector name on the combination sewer cleaner you use. With Vector, you get high air flow – enough to power an 8-inch hose, so you can suck up heavy debris, wet or dry. One more thing: Vector is made in America, so parts and service are available at a Vector dealer near you.

To see for yourself how the Vector 2100 Plus delivers safety and performance, call 800.627.3171 or visit [www.vector.com](http://www.vector.com).



Visit Vector at **Booth 5038a** at the Water & Wastewater Equipment, Treatment & Transport Show, Feb. 24-26, 2015, in Indianapolis.



©2015 Vector Manufacturing. All rights reserved.







**WORLDWIDE  
LEADER IN  
SMALL DIAMETER  
SOLUTIONS**

GET STARTED TODAY FOR  
AS LOW AS \$486.06/ MONTH

**CONTACT US**

1-800-834-9597  
INFO@NUFLOWTECH.COM  
WWW.NUFLOWTECH.COM

**WE'RE HIRING!**

Find a career  
at Nu Flow!

**pneumatic cutters**



\*Available to Public

**non pressurized systems**



**pressurized systems**



**THE CABLE CENTER 1-800-257-7209**

**MIDWEST'S LARGEST FACTORY AUTHORIZED  
REPAIR CENTER FOR GATORCAM, GEN-EYE & SEESNAKE**

**24  
HOUR  
TURNAROUND**

**FREE  
DELIVERY  
ON ALL RIDGID  
CAMERA  
KITS**

**RIDGID's NEW  
CS10 Digital Recording Monitor**

- USB Thumb Drive
- 12.1" Daylight Readable Display
- Multi Mode Recording  
take snapshots, record full video & lean video
- Software Integrations  
with SeeSnake HQ & RIDGIDConnect™



CALL FOR  
SPECIAL  
PRICING ON  
ALL CAMERA  
KITS!

• THE CABLE CENTER • 8318 OLIVE BLVD. • ST. LOUIS, MO 63132 • 314-993-3099 •



# Be a Better Boss

There are specific, key leadership characteristics that all employees want from management

By DeEtta Jones

**D**o you ever feel overwhelmed as a manager? Being overburdened by the responsibility of having to figure out what others want and need of you is a familiar feeling shared among leaders. Fortunately, there is a “best practice” for obtaining just the kind of information needed to increase your leadership effectiveness — ask them what they want.

The following 10 traits have emerged when frontline staff, supervisors and middle managers have been asked to describe the traits they look for in a boss. As you read through their wish list, think about the kind of boss you are and what you look for in a good boss.

Employees want bosses who are:

## Innovative

Good bosses have good ideas, but their role in innovation is more as facilitator than consummate mastermind. They are not threatened by the talent of their employees and cultivate a working environment that allows each person’s creativity to come forward. They facilitate innovation.

## Coaches

Good bosses provide important education and guidance that help employees see how their work is contributing to the larger goals of the organization.

They help employees build confidence by giving stretch assignments that require demonstration of new skills and right-sized risk, then provide feedback that allows needed course corrections to be made early enough to avoid a major failure. When employees do fail, good bosses encourage reflection and identification of learning that can be applied to future endeavors.

**Good bosses are genuine, have integrity and behave in a manner consistent with their word and values. Employees trust bosses they know to be intelligent, capable and who have a demonstrated track record of acting in their best interest.**

## Caring

Good bosses listen to their employees and show an interest in their opinion. They provide opportunities to talk openly and encourage personal and professional growth, sometimes by giving access to resources (like professional development experiences) and sometimes by removing barriers.

## Strategic

Good bosses can make hard choices and have the finesse needed to get people behind even unpopular decisions. They are able to secure resources for important initiatives and use analytical frameworks for guiding change, promoting transparent processes and communication. Strategic bosses are decisive (not to be confused with closed-minded or dogmatic). Once a decision has been made, they stick with it and avoid changing directions quickly or sending mixed messages.

## Visionary

Good bosses are also visionary managers, able to clearly see and build a commitment toward a compelling future state. They articulate a sense of direction, map out the path and shepherd the process.

## Trustworthy

Good bosses are genuine, have integrity and behave in a manner consistent with their word and values. Employees trust bosses they know to be intelligent, capable and who have a demonstrated track record of acting in their best interest. They give and receive (even invite) feedback, affirmative and constructive. They are fully aware of their scope of power in the organization and in their relationship with employees, and recognize how an off-handed comment or unpleasant glance may ruin someone’s entire weekend.

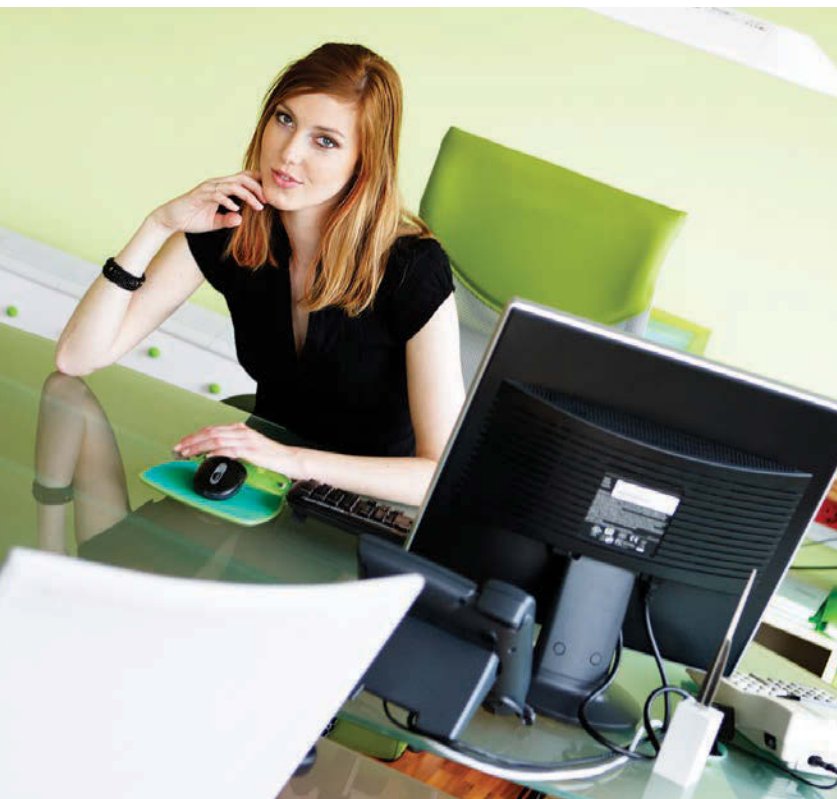



### Accessible and adaptable

Good bosses are able to balance how they give support and direction with the freedom employees need to do their work, acknowledging experience and expertise over their domain. They understand that each employee comes to the workplace with unique experiences, needs and cultural lenses that will require individualized attention and support, and can adapt their own style to ensure effective communication and levels of productivity.

### Passionate

Good bosses have a fire in their belly about something — particularly the vision and mission of the organization, the people with whom they work, and whom their products and services are meant to touch. They are the first to roll up their sleeves to contribute and model the level of motivation and quality required for achievement of organizational goals. They help employees stay connected to their own passion by encouraging the sharing of ideas and then helping to shape them to fit within and be supported by the larger organization.

### Champions

People want to know that the person to whom they report is on their side, even when mistakes are made. Champions look for opportunities to catch their employees doing a good job and go out of their way to point it out. They don't take the credit for their employees' work and they don't throw an employee under the bus — ever. They "influence up" by being a conduit between their employees and higher level decision-makers, often helping their employees develop the language and influence strategies needed to take an idea to the top of the organization.

### Fun

Good bosses are willing to laugh and value a work environment that encourages meaningful relationships between colleagues. They inspire us by making the connection from our head to our heart about the importance of our work and our value to the company.

Here's the leadership's next step: Reflect on the list and identify qualities you are modeling. Think about where there is room for growth in your leadership practice — growth that will lead to increased levels of motivation and engagement. Finally, begin encouraging your employees to share their own needs and allow for timely adjustments. **c**

### ABOUT THE AUTHOR

DeEtta Jones is a leadership strategist, social justice advocate and author. For more information, visit [www.deettajones.com](http://www.deettajones.com).

## Storm Tractor



## Lateral Launch



## Private Eye 2



## PoleCAM



## The CUBE



*conductor*  
**THE SINGLE SOLUTION**

[www.rstechserv.com](http://www.rstechserv.com)



come see what's new

**vwvett**  
BOOTH  
2431

**Productivity + Power** for all your inspection needs

- Cameras  
Pan & Tilt, Zoom, JetCam, Pole, Well and Panomorphic
- Tractors / Transporters  
Wheeled, Track and Steerable
- Vehicles & Trailers  
High Cube, Step, Sprinter and Cargo Vans, ATVs and Trailers
- Lateral Launch
- Profiling  
Laser and Sonar
- Software

also available thru  
**HGACBuy.com**  
THE TRUCK PURCHASING SOLUTION

For more info call or visit us online today

**RS** Technical Services Inc.  
Design and Manufacture of Video Pipeline Inspection Systems



1800.767.1974    sales.info@rstechserv.com



**RUGGED & RELIABLE**

**Performance by Design**

**Made in USA**

**Ideal For Grease Trap Service**



**ELECTRIC POWERED**



VISIT US AT THE  
**WWETT SHOW**  
Booth# 5124

**PRO-VAC**

**INDUSTRIAL PUMPOUT UNIT**



**GASOLINE POWERED**

[www.westmoorltd.com](http://www.westmoorltd.com)

Westmoor Ltd., 906 West Hamilton Ave, Sherrill, NY 13461

**TEL (800) 367-0972**



**VIVAX  
METROTECH**

# vCam-5

— Inspection Camera —

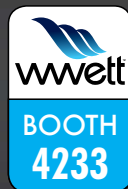

- 8" Daylight Readable LCD
- Wi-fi and RS232 Interface
- Stainless Steel Construction
- Locatable Pushrod and Sonde
- Self-Leveling Color Camera Heads
- Internal Li-ion Rechargeable Battery

**Training Provided Free of Charge**

**Please call us to schedule an on site, no obligation demonstration!**

Vivax-Metrotech Corporation

3251 Olcott Street, Santa Clara  
CA 95054, USA

Toll Free: +1-800-446-3392  
Tel: +1-408-734-1400

Fax: +1-408-734-1415  
Email: [sales@vxmt.com](mailto:sales@vxmt.com)



**SHOP ONLINE AT WWW.DURACABLE.COM**

**20% OFF**

**DURACABLE  
MANUFACTURED  
PRODUCTS\***



**30-DAY  
GUARANTEE  
ON CABLE**



**FREE  
SHIPPING WITH  
\$1500 ORDER**

\*Including ProClean drain care. + Free Shipping with \$1500 order. Excludes private label, SRD and RootX. Not valid with any other offer. 2/9/15 - 3/13/15 Promo#468



**BUILT  
U.S.A.  
TOUGH**



**Just give us a call at 877-244-0556.**

The one-stop source for all your plumbing and drain cleaning needs – Duracable Manufacturing. Or visit us on the web at [www.duracable.com](http://www.duracable.com)







# wwett™ 2015

Water & Wastewater Equipment, Treatment & Transport Show

To register or for  
detailed information:

**wwett.com**  
**866-933-2653**

**FEBRUARY 23-26, 2015 INDIANA CONVENTION CENTER**

## Current Exhibitor List

558 companies - list current as of January 5, 2015.

- 3T Equipment Company Inc.  
A. Rhodes Wilson & Associates, Inc.  
A.R. North America  
Abbott Rubber Company, Inc.  
ABCO Industries Limited  
Absolute Ablutions  
Mobile Trailer Manufacturer  
Acro Trailer  
Advance Pump & Equipment  
Advanced Containment Systems Inc.  
Advanced Drainage Systems  
Advanced Infrastructure Technologies  
Advanced Pressure Systems L.P.  
Advantage Funding  
Aero-Tech  
Airfeet  
AK Industries Inc.  
Alderson Industries, Inc.  
All Star Sewer Equipment  
Allan J. Coleman Co.  
Allied Forward Motion LLC  
Allied Graphics  
Alpine Equipment Funding, Inc.  
Alteris-SeptiCover  
AlumaMATS, Inc.  
Amazing Machinery, LLC.  
Ameri-Can Engineering  
American Express OPEN  
American Melt Blown & Filtration Inc.  
American Pipe & Plastics, Inc.  
Amesbury / Bandlock Products  
Amthor International  
Anderson Metals Corp., Inc.  
Anuro  
AP/M Permaform  
Aqua Blast Corporation  
Aqua Male Technologies Inc.  
AquaSales by V.P. Marketing  
Arcan Enterprises Inc.  
Aries Industries Inc.  
Armal, Inc.  
ART Company  
(A Restroom Trailer Company)  
Arthur Custom Tank / Mid-State Tank  
Arthur Products Co.  
Ashland PolyTrap  
Ashland Pump  
Atlanta Rubber & Hydraulics Inc.  
Avanti International  
B Green Group  
Bad Dog Tools  
BakerCorp  
Ball Brass and  
Aluminum Foundry Inc.  
Banjo Corporation  
Barnett  
BASE Engineering Inc.  
Bayco NightStick /  
The Jolly Group, Inc.  
BDP Industries, Inc.  
Benjamin Media Inc.  
Benlee Roll Off Trailers  
Best Enterprises Inc.  
Best Equipment Company  
Betts Industries Inc.  
Biffs Pathfinders, LLC  
BioNyxus  
Bio-Microbics Inc.  
Bionetix International  
Bio-Systems International  
BKP Beralina Polyester  
GmbH & Co. KG  
Black Tie Products
- Blasters, Inc.  
Blue Angel Pumps  
bluefrog Plumbing + Drain™  
BODUS GmbH  
Boerger LLC  
Brandenburger Liner GmbH & Co. KG  
BRAWOLINER  
Brenlin Company, Inc.  
Bright Dyes  
Bright Technologies Specialty  
Div. of Sebright Products, Inc.  
Brothers Equipment  
Brown Bear Corporation  
Burkham Pumps, Inc.  
Bucks Fabricating  
Bulk Toilet Paper  
Bull Frog Industries LLC  
BW Technologies by Honeywell/  
Honeywell Analytics  
C&E Plastics Inc.  
C&H Services  
C.I.Agent Solutions  
Cam Spray  
Canam Equipment Solutions, Inc.  
Campus Industries Ltd  
Cape Cod Biochemical Co.  
CAPPELLOTTI S.P.A.  
Cat Pumps®  
Cavallero Plastics, Inc.  
CEMTEC / A.W. Cook Cement  
Products  
Champion Pump Company, Inc.  
Chandler Equipment  
Chelsea Products/Div. of Parker  
Chempace Corporation  
Chempure Products Corp.  
Cheme Industries  
CIPP Services, LLC  
Clayton Industries  
Clear Computing  
Clearstream Wastewater Systems  
Cloverleaf Tool Co.  
Cobra Technologies  
Comet USA, Inc.  
Comforts of Home Services, Inc.  
Concrete Sealants Inc.  
Coneqtec-Universal  
Consolidated Treatment Systems, Inc.  
Containment Solutions  
CoreBiologic, LLC  
Cotta Transmissions  
Cougar Vibration,  
Div of Martin Engineering  
COXREELS  
CPACEX  
Crescent Tank Manufacturing  
Cretex Specialty Products  
CromFlow Inc.  
Crust Busters/Schmitz Bros.  
CUES  
Cummins Power Products  
De Neef Construction Chemicals  
Del Val Chem Co.  
Depth Ray  
Ditch Witch  
Dove Ventures Inc.  
Downey Ridge Environmental  
Dragon Products  
Drainables Direct  
DryLet LLC  
Dulmeier Sales  
Duraocbe Manufacturing  
Dyna Flex Inc.
- Dynablast  
DynaLiner LLC  
Dynamic Decals & Graphics, Inc.  
Dynamic Filtration Limited  
Dyna-Vac Equipment  
E Z Onsite  
Easy Kleen Pressure Systems Ltd.  
Easy Liner  
Eco Infrastructure Solutions  
Ecological Laboratories Inc.  
Eldon C. Shutsman, Inc.  
Electric Eel Mfg.  
ElaMech, Inc.  
Eljen Corporation  
Entriologics Engineering Inc.  
Environment One Corporation  
EnviroSight  
Enviro-Tech of America, Inc.  
Enz USA Inc.  
Eggs Products  
E-Tank, Ltd. / E-Pump  
Explorer Trailers - McKee Technologies  
EZTRAKR Systems  
Farmhost Apps  
Federal Signal Environmental  
Solutions Group  
FeraTex  
Fieldbook ERP  
Fisher Labs  
Five Peaks  
FKC Co. Ltd.  
Fleetmatics  
Flo Trend Systems  
FlowMark, LLC  
FM Manufacturing Inc.  
Forbest Products Co.  
Ford Commercial Vehicles  
Foremost  
Forest River, Inc.  
FORMADRAIN Inc.  
Franklin Electric  
Fruitland Manufacturing  
Fuji Clean USA, LLC  
Ganajet, part of the Alfa Laval Group  
GapVax Inc.  
Gardner Denver Water Jetting  
Systems  
Gardner Denver Wittig  
GE Oil & Gas - Roots Blowers  
GEA Farm Technologies, Inc. (USA)  
General Pipe Cleaners  
General Pump  
Geoflow, Inc.  
German Pavilion/Federal Ministry for  
Economic Affairs and Energy  
GGG Instrumentation, Inc.  
Giant Industries  
Global Vacuum Systems, Inc.  
Go Green Environmental Products  
Gowin, a Xylem Brand  
Goldak Inc.  
Goritz Sewer & Drain, Inc.  
Gorman-Rupp Company  
GPM Pump & Truck Parts, LLC  
GPS Insight  
Grease Guardian  
Green Mountain International, LLC  
GRU, LLC  
HZ Technical Rescue Equipment  
Hammellman LLC  
HammerHead Trenchless Equipment  
Hannay Reels Inc  
Happy Feet
- Harben Inc.  
Hart Industries  
Hathorn Corporation  
Hauler Agent  
HCP Pumps of America, Inc.  
Hedstrom Plastics  
Helix Laboratories Inc.  
Hella, Inc.  
Hermann Sewerin GmbH  
Hermes Technologie  
Hibon, Inc.  
(a division of Ingersoll Rand)  
Hino Trucks  
Hi-Vac Corporation  
Hot Jet USA  
Hurco Technologies Inc.  
EnviroSight  
Hydro-Flex, Inc.  
Hydro-Tech Pumps  
Hy-Flex Corporation  
I.S.T. Innovative Sewer Technologies LLC  
IBG HydroTech  
Imperial Industries Inc.  
Impreg International GmbH  
IMS Robotics GmbH  
In The Round Dewatering  
Indiana Onsite Wastewater  
Professionals Association  
Infiltrator Systems Inc.  
InfoSense, Inc.  
Infrastructure Repair Systems, Inc.  
Infrastructure Technologies - ITipics  
Innovative Equipment, LLC  
InSight Mobile Data Inc.  
Insight Vision Cameras  
Integrated Vehicle Leasing /  
Financing  
ITI Trailers & Truck Bodies Inc  
J&J Chemical Co.  
J. Hvidhved Larsen US  
J.C. Gury Company, Inc.  
Jack Doherty Companies  
JAG Mobile Solutions  
Jameson LLC  
JD7  
Jet Clean Tools USA Inc.  
JET Inc.  
JeTech, Inc.  
Jets Vacuum AS  
Jetter Depot  
Joe Johnson Equipment, Inc.  
John Bean Jetters  
Johnny's Choice by Chemcorp  
Joints Couplings  
KeeVac Industries Inc.  
KEG Kanalreinigungstechnik GmbH  
Keith Huber Corporation  
Kentucky Tank, Inc.  
Kewanna Screen Printing  
Kifo, Inc.  
Kros International USA  
Kroy Industries  
Kuriyama of America, Inc.  
LANSAS Products  
Mfd. by Vanderlans & Sons, Inc.  
LaPlace Equipment Co Inc.  
Lely Manufacturing, Inc.  
Lanzyme/Trap-Clear Inc.  
Liberty Financial Group, Inc.  
Liberty Pumps  
LIFTPLAQ  
Linco-Precision, LLC  
Liquid Environmental Solutions  
Liquid Waste Industries
- Liquid Waste Technology LLC  
LMK Technologies  
LMT Inc.  
Lock America, Inc.  
Locqus  
Lodar Ltd.  
Logan Clutch Corporation  
Logiball Inc.  
Longhorn Tank & Trailer  
Ludwig Pfeiffer Hoch- und  
Tiefbau GmbH & Co. KG  
MacQueen Equipment Group  
Madwell Products Corporation  
Mailhot Industries  
Mainline Backflow Products, Inc.  
Masport Inc  
Masterliner, Inc.  
Material Motion, Inc.  
MaxLiner USA  
McLaughlin Group, Inc.  
Medit Inc.  
Meese Orbitron Durne Company  
Merrell Bros., Inc.  
Mid-State Tank Co., Inc.  
Midwest Vac Products LLC  
Miller Pipeline  
Milliken  
Miller-Haufen Tool Company  
Milwaukee Pump  
Milwaukee Rubber Products Inc.  
Mi-Machine  
Mobile Hydraulic Equipment Co., LLC  
Mobile Restroom Designs  
Money In Motion  
MONOFORM by Infratec  
Moro USA  
Mr. Rooter Corp.  
MTC  
MTEch  
Mud Technology International, Inc.  
Murphy by Enovation Controls  
MyLana Mfg. Co. Inc.  
NASSCO, Inc.  
National Precast Concrete Association  
National Truck Center  
National Vacuum Equipment  
Nature Calls  
NAWT - National Association of  
Wastewater Technicians  
Netafim USA  
Nextstar Network, Inc.  
NLB Corp.  
Northeast Industrial Mfg  
Norweco Inc.  
NovaFlex Hose  
NOWRA - National Onsite Wastewater  
Recycling Association  
Nozzleg, Inc.  
NSF International  
No Flow  
Oakmont Capital Services LLC  
Oceanquig Cables, LLC  
Ohio Electric Control, Inc.  
Omega Liquid Waste Solutions  
OMSI Transmissions, Inc.  
One Biotechnology  
Orenco Systems, Inc.  
Otto Trading Inc.  
PA Spa  
Parson Environmental Products Inc.  
Pat's Pump & Blower  
PC Scale Technologies  
Peapoint/SPX
- Painemann Equipment  
Penn Valley Pump Co., Inc.  
Penny Pockets  
Pentair  
People's United Equipment  
Finance Corp.  
Perma-Liner Industries LLC.  
Petersen Products  
Petrofield Industries  
Phoenix USA Inc.  
Picote Solutions  
Pik Rite Inc.  
PinPoint GPS Solutions Inc.  
Pipe Lining Supply, Inc.  
PipeHunter, Inc.  
Pipeline Analytics  
Pipeline Renewal Technologies  
PipeLogix Inc.  
Pipe-Robo-Tec USA  
PipeTech Software  
Piranha Hose Products  
Plug-It Products  
Polston Applied Technologies  
PolyFlow  
PolyJohn Enterprises Corp.  
Poylok Inc. / Zabel  
PortaPortables, LLC  
Porta Pro Chemical Company  
Portable Sanitation  
Association International  
POWER Software LLC  
Possmark International Inc.  
Pow-R Mole  
Premier Oilfield Equipment Co.  
Premier Tech Aqua  
Presby Environmental, Inc.  
Pressure Lift Corporation  
Presvac Systems, Ltd.  
PRIME DRILLING GmbH  
Prime Resins, Inc.  
PrimeLine Products  
Progress Tank  
Rain for Rent  
Ranah-USA, Inc.  
RanProSe, A Schieffler Company  
Protective Liner Systems  
PSI Pressure Systems Corp  
PUMTEC  
Qingdao Donghengli Industry  
Equipment Co., Ltd.  
Quadox / Interfit  
Quik-Lining Systems, Inc.  
R. Nesbit Portable Toilets  
Rain for Rent  
Ram Commercial  
RapidView IBAK North America  
Raftech Electronics, Ltd.  
Rausch USA  
Ravo Sweepers  
RC Industries Inc.  
RCS II Inc.  
RecoverE  
REED Manufacturing Company  
Reelcraft Industries Inc.  
Retracon  
Reline America Inc.  
Renssi  
Resplast US, Inc.  
ReviewBuzz  
RH20 North America Inc.  
Rich Specialty Trailers  
RIDGID  
Rioned UK Limited
- Ritam Technologies, LLC  
RITEC GmbH  
RKI Instruments, Inc.  
Robinson Vacuum Tanks, Inc.  
Robuschi & C.S.p.A.  
Rochester Metal Products Corp  
RODDIE Inc.  
Roeda Signs & ScreenTech Imaging  
Roll-Off Parts.com  
RootX  
Roth Global Plastics  
ROTENBERGER USA  
RotoSolutions  
RouteOptix Inc.  
RS Technical Services Inc.  
Rush Refuse Systems  
Rush-Overland Manufacturing  
Sabre Manufacturing  
SAERTX multiCom LP  
Safety Sewer Drain  
Salcor, Inc.  
Satellite Industries Inc.  
Saverusen, Inc.  
Sawtech Corp.  
Scorpion Protective Coatings  
Screenco Systems LLC  
Sealing Systems Inc.  
SECO Truck Inc.  
See Water Inc.  
Septic Maxx  
Septic Products Inc.  
Septic Services Inc.  
SeptiTech  
Septronics, Inc.  
Service Roundtable  
SnakeLiner  
Sewer Equipment  
Shamrock Pipe Tools Inc.  
Shenzhen Schroder Industry Measure  
& Control Equipment Co., Ltd.  
Sherwin Williams  
ShuBee  
Sim/Tech Filter Inc.  
SJE-Rhombus  
Slewmaster Inc.  
Slide-In Warehouse  
SludgeHammer Group Limited  
SnakeLiner  
Solar LED Innovations, LLC  
Sonetics Corporation  
Source 1 Environmental  
Southland Tool Mfg. Inc.  
Spartan Tool LLC  
Specialty B Sales  
Splendor Fiberglass  
Stamp Works  
Standard Cement Materials, Inc.  
Standard Equipment Company  
Statewide Supply  
StoneAge, Inc.  
Strike Products  
Sturgeon Tank & Equipment  
Stutes Environmental Federation  
Subsurface Instruments  
Surgico Corp.  
Sunbelt Rentals  
Super Products LLC  
Superior Environmental Solutions  
(SES, Inc.)  
Superior Signal Company LLC  
Supervac 2000  
Surco Portable Sanitation Products  
Surpresseur 4S Inc.
- SVE Portable Roadway Systems, Inc.  
T & T Tools, Inc.  
T4 Spatial  
Tank Track LLC  
Tank Transport Trader  
TCF Equipment Finance  
Terydon Inc.  
The Strong Company  
Thieman Tailgates, Inc.  
Thompson Pump  
Titan Logix Corp.  
Topp Industries, Inc.  
Trade-Serve  
Trans Lease, Inc.  
Transway Systems Inc.  
Trellberg Pipe Seals  
TRIC Tools Inc.  
Trillium Industrial Services  
TRY TEK Machine Works, Inc.  
TSF Co. Inc.  
Tsurumi Pump  
TT Technologies Inc.  
Tuf-Tite Inc.  
Turbo-Fog  
Division of Kingscote Chemicals  
Turtle Plastics  
U.E.M.S.I.  
Udor USA  
UHRIG Kanaltechnik GmbH  
Ultra Shure  
UltraLay by Wells Cargo  
Uncle Freddie's Super Gloves  
Under Pressure Systems, Inc.  
US Fleet Tracking  
US Jetting, LLC  
USA BlueBook  
USB-Sewer Equipment Corporation  
VAC2GO  
Vocal  
Vac-Con Inc.  
Vacutrux Limited  
Vacuum Sales, Inc.  
Vacuum Truck Rental  
Vaporoater  
VAR Co.  
Vermeer  
Veyance Technologies, Inc.  
Vivax-Metrotech Corp.  
Vogelsang  
VT Hackney  
Vu-Rite Video Inspection Systems,  
Wachs Utility Products  
Wager Company Inc.  
Walex Products Company, Inc.  
Wallerstein Vacuum Pumps -  
Elmira Machine Industries  
Wastequip  
WasteWater Education 501(c)(3)  
Water Environment Federation  
Waterblasting Technologies  
WC Leasing  
Weber Industries, Inc. (Webtrul)  
Wee Engineer Inc.  
Wells Fargo Equipment Finance  
Western Equipment Finance  
Western Mule Cranes (D & S Sales)  
Westmool Ltd.  
Whirlygig, Inc.  
Wiedemann & Reichardt GmbH  
Wieser Concrete Products, Inc.  
Wohler USA  
Zhejiang Danau Industries Ltd.  
Zoeller Pump Company



# Jetstream's hands-free waterblast solutions deliver improved operator safety, productivity

Provides broadest offering of hands-free cleaning solutions and training in the industry



Jetstream of Houston, LLP, a leading manufacturer of industrial high-pressure waterblasting equipment, parts and accessories, continues to invest and grow in providing industrial cleaning contractors with the most productive hands-free solutions available. By partnering with the leading manufacturers of automated tools and robotics – including Aquajet Systems, Peinemann, StoneAge and Terydon, Jetstream offers the industry's best total equipment solutions for such hands-free, high-pressure waterblasting applications as hydrodemolition, pipe cleaning, surface cleaning and preparation, tank and vessel cleaning and tube cleaning.

“These strategic partnerships enhance Jetstream's product offering and provide customers with greater access to category-leading specialty equipment and accessories that enhance operator safety and productivity and help contractors perform their jobs more profitably,” said Joe Varca, business unit director at Jetstream. “The collaboration with these well-known automation partners, combined with our nine FS Solutions authorized retail support and rental centers across the United States, enables Jetstream to better meet our customers' needs for total hands-free solutions, including the purchase and/or rental of Jetstream waterblasting equipment, parts, accessories, training and service support.”

With the goal of reducing the number of workplace fatalities and injuries related to improper use of high-pressure waterblasting and providing a safer environment for equipment operators, Jetstream is developing and delivering hands-free waterblasting solutions and training to industrial cleaning contractors. As part of the initiative, Jetstream's experts consult with customers, visiting job sites to identify the right hands-free waterblasting solutions for the location.

“Jetstream and FS Solutions can demo, sell and rent the broadest offering of hands-free cleaning solutions in the industry, including automated and robotic tools and accessories.” Varca said.

**WE'RE NOT QUITE HERE YET.**

**BUT WE'RE CLOSE.**

Though Jetstream is the industry leader, we're constantly looking for new ways to advance hands-free automated operations. We've partnered with the leading manufacturers in the industry to offer the broadest line of hands-free waterblasting solutions. We have cutting-edge automated and robotic tools as well as accessories. We also have the most experienced application experts in the business for all of your consulting and productivity solutions. Contact Jetstream or your local FS Solutions and Jetstream rental center today.

## Jetstream's Hands-free Waterblast Solutions

Jetstream manufactures high-pressure waterblasting equipment operated at pressures up to 40,000 psi for a wide range of applications, including industrial cleaning and surface preparation. Backed by strong after sales service and support, Jetstream product offerings include a complete line of skid- and trailer-mounted pump units, control guns, valves, hoses, replacement parts and nozzles.



A proud member of the Federal Signal Family.



www.waterblast.com 1.800.231.8192





# Education Day Sessions

Monday, February 23, 2015

## NAWT

National Association of Wastewater Technicians  
Room 234-236

- 8 a.m. | Pre-Trip Inspections
- 9:30 a.m. | Hours of Service (HOS) Overview
- 11 a.m. | Roadside Inspections
- 1:30 p.m. | Environmental Impact Study: Effects of Water Softener on Septic Tank Performance
- 3 p.m. | A Study of Microbiological Induced Corrosion
- 4:30 p.m. | Ask the Expert Q & A

## WJTA-IMCA

Water Jet Technology Association  
Industrial Municipal Cleaning Association  
Room 140-142

- 8 a.m. | Hydroexcavation — Tools to Stay Current in a Changing Marketplace
- 9:30 a.m. | Maximizing Productivity on Vacuum/Air Mover Projects
- 11 a.m. | Waterblast Safety Can Enhance Productivity, Quality and Profits!

## SSCSC

Southern Section Collection Systems Committee  
Room 231-233

- 8 a.m. | Combination Vacuum Unit Operation Overview
- 9:30 a.m. | Been There, Done That, Got The T-Shirt (Small Business From a Hands-on Perspective)
- 11 a.m. | So You Think You Are the Best? CCTV Inspection In Its Highest Form
- 1:30 p.m. | Avoid the Pitfalls — Trenchless Pipeline Repair and Renewal
- 3 p.m. | NOZZLES, NOZZLES, NOZZLES!
- 4:30 p.m. | Ask the Experts Q & A

## SSPMA

Sump and Sewage Pump Manufacturers Association  
Room 243-245

- 1:30 p.m. | Sizing Guidelines for New or Replacement Sewage Pumps
- 3 p.m. | Backup Battery and Combination Pump Systems Evaluation and Installation
- 4:30 p.m. | Specifying Pumps: Why Do Pumps Fail?

## NASSCO

National Association of Sewer Service Companies  
Room 130-132

- 8 a.m. | Overview of Manhole Rehabilitation Technologies
- 9:30 a.m. | When, Why and How to Defeat Infiltration Cost Effectively
- 11 a.m. | New Opportunities in Small-Pipe Relining and Reinstatement
- 1:30 p.m. | Pipeline cleaning Best Practices
- 3 p.m. | Large-Diameter Pipe and Drain Rehabilitation Technologies
- 4:30 p.m. | Ask the Experts Q & A

## NEHA

National Environmental Health Association  
Room 237-239

- 8 a.m. | New Technologies for Non-Potable Water Use
- 9:30 a.m. | Rules & Regulations with New Technologies and Working with Regulators
- 11 a.m. | New Technologies for Non-Potable Water Use Part 2
- 1:30 p.m. | OSHA Regulations and Smart Business
- 3 p.m. | Sales & Marketing with New Technologies
- 4:30 p.m. | Ask the Experts Q & A

## NOWRA

National Onsite Wastewater Recycling Association  
Room 240-242

- 8 a.m. | Lobbying
- 9:30 a.m. | Field Inspections Part One
- 11 a.m. | Field Inspections Part Two
- 1:30 p.m. | Septic Tank Safety — Lethal Lids
- 3 p.m. | Time Dosing
- 4:30 p.m. | Ask the Experts Q & A

## Portable Restroom Track

Beverly Lewis  
Room 243-245

- 8 a.m. | Mastering the Busy Season
- 9:30 a.m. | A Great Customer Experience
- 11 a.m. | Employee Retention and Recruitment

## Business Track

Kelly Newcomb, Ellen Rohr, Women's Roundtable  
Room 136-138

- 8 a.m. | Grow or Go! Why Most Companies Fail to Grow Effectively and What You Can Do to Keep Your Company From Failing
- 9:30 a.m. | Target Marketing: How to Effectively and Efficiently Grow Your Sales
- 11 a.m. | Effective Branding and How it Can Help Your Business
- 1:30 p.m. | Business Basics 101
- 3 p.m. | Build the Business You REALLY Want
- 4:30 p.m. | Women in Wastewater Roundtable Discussion

Gil Longwell  
Room 140-142

- 1:30 p.m. | Protecting Private Enterprise

## Marketing Track

Susan Chin  
Room 133-135

- 8 a.m. | Ladies and Gentlemen: Create Your Personal Brand and Strategic Network for Success in 5 Easy Steps
- 9:30 a.m. | Effective Website Design and Engaging Customers in the Digital Age
- 11 a.m. | Tapping into the Power of Social Media and Content Marketing

## Road Rules & Safety Track

John Conley  
Room 133-135

- 1:30 p.m. | A Trucker's Guide to Washington Speak
- 3 p.m. | Cargo Tank Safety and Regulatory Report
- 4:30 p.m. | Compliance with Part 180 and Preparing for a Tank Truck CT Shop Audit

(continued)

You can view the complete schedule of events along with an exhibitor list, floor plan, travel information and everything else you'll need to plan your trip to Indy at [www.wett.com](http://www.wett.com)





# GORLITZ SEWER & DRAIN INC.

Norwalk Blvd. Santa Fe Springs, Ca. 90670

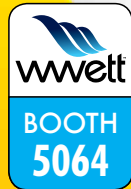

- MACHINES
- FEEDERS
- CABLES
- RAMPS
- CONNECTORS
- LEADERS
- CHUCKS
- ENDS
- RETRIEVERS
- SPLICES
- AUGERS
- JETTERS
- NOZZLES
- HOSES
- TRENCHLESS PIPE SYSTEMS
- SOCKET FUSION KITS

*Engineering, Dedication, Quality, Sales and Service All In One Stop!*

www.gorlitz.com  
 Email: sales@gorlitz.com  
 f GORLITZ on Facebook



Tel: (562) 944-3060  
 Fax: (562) 944-7630





# Tuesday Sessions

Detailed session information available at: [wwett.com](http://wwett.com)

February 24, 2015

## NAWT Track

Room 234-236

- 8 a.m. | Septage Processing Introduction:  
Working with an Engineer
- 9:30 a.m. | Analyzing Your Resources:  
What Goes on Around You is Important!
- 11 a.m. | Introduction to Odor Control

## Onsite Installer Track

Room 231-233

- 8 a.m. | Soils, Design, O&M: What Every Installer  
Should Know
- 9:30 a.m. | Best Installation Practices for  
Trouble-Free Pump Controls
- 11 a.m. | Introduction to Effluent Filters

## \*MSW Track

Room 237-239

- 8 a.m. | Mapping Solutions for Repair and  
Maintenance of Water Distribution Systems
- 9:30 a.m. | The Shift from Reactive to Proactive  
Wastewater Management Best Practices
- 11 a.m. | Why Hasn't Your Sewer System Evaluation  
Survey Testing Worked?

\*MSW - Municipal Sewer & Water

## Treatment Plant Operator Track

Room 240-242

- 8 a.m. | An Emerging Technology for Lagoon-Based  
Nutrient Removal
- 9:30 a.m. | The New Wastewater: Collection System  
Challenges Caused by Today's Modern Trash
- 11 a.m. | Wastewater Microbiology

## Industry Safety Track

Room 243-245

- 8 a.m. | New Trends and Technology in Equipment  
for Excavation Safety
- 9:30 a.m. | Best Practices: Use, Care and Repair of  
High-Pressure Sewer Cleaning Hose
- 11 a.m. | Development and Execution of a Cross-Bore  
Prevention Program

## Business Track

Room 130-132

- 8 a.m. | How to Position Your Company in the Market Today
- 9:30 a.m. | Six Proven Tactics to Generate Leads and  
Turn Them Into Revenue
- 11 a.m. | Growth by Acquisition or Exiting Gracefully:  
Buying or Selling a Septic or Sewer Business

## Drain Cleaning Track

Room 133-135

- 8 a.m. | Drain Cleaning Methods - Then and Now
- 9:30 a.m. | The Physics of Pipe Cleaning Tools and  
How I Make it Work for Me
- 11 a.m. | Lateral Lining - Are You Using the Right Tool?

## Industry Technology Track

Room 136-138

- 8 a.m. | How to Manage Septic Systems  
using Remote Monitoring
- 9:30 a.m. | GPS Tracking: Hype Vs. Reality
- 11 a.m. | Wireless Controls in the Waterjet Industry:  
Sacrificing Safety for Convenience

## Septic Series Track

Room 140-142

- 8 a.m. | True Crime Scene Stories: How to Inspect  
and Troubleshoot Suspect Onsite Systems
- 9:30 a.m. | One Man's Waste is Another Man's Treasure
- 11 a.m. | Dewatering Options for Roll-Off Containers

(continued)



\*Complete contest rules and details at: [wwett.com/rules](http://wwett.com/rules)



# AMAZING MACHINERY

Your Equipment SUPERSTORE Since 1995

## Viztrac® AM100-100



**ONLY**  
**\$1495.00**

- 20' Reel w/ 100' of 3/8" Cable
- 7" Color LCD Display
- Heavy Duty Powder Coated Frame

~~\$1895.00~~  
FREE Freight

## J/E4040HA-CKIT2



**ONLY**  
**\$1495.00**



- 4000 psi @ 4.0 gpm w/Pump
- GX390 Honda OHV Engine
- 150' x 1/4" Hose w/Remote Hose Reel
- 3 Nozzles/Ball Valve/Aqua Pulse

~~\$1895.00~~  
FREE Freight



**BUY BOTH**  
**\$2895.00**

**6 Months, No Interest!**



Get 6 Months to Pay on Purchases of \$99 or More.  
Choose Bill Me Later® at Checkout. Subject to Credit Approval.



Complete Details At  
[www.AmazingMachinery.com](http://www.AmazingMachinery.com)

**1-800-504-7435**  
3807 Old Tasso Rd. • Cleveland, TN 37312





# Wednesday Sessions

Detailed session information available at: [wwett.com](http://wwett.com)

February 25, 2015

## Septic Series Track

Room 140-142

- 8 a.m. Considerations in Building Your Next Vacuum Truck
- 9:30 a.m. Grease Collection and Treatment:  
Raising the Bar Via Resource Recovery
- 11 a.m. Analyzing Common Onsite Septic System  
Malfunctions and Options for Prevention & Correction

## \*MSW Case Study Track

Room 231-233

- 8 a.m. Retrofit of the Lansdowne Sanitary P/S
- 9:30 a.m. Huntington Beach Successfully Navigates  
Emergency Repair of Fragile Storm Drain  
Collection System Rehabilitation –  
Alternative Technology
- 11 a.m. Collection System Rehabilitation –  
Alternative Technology

## \*MSW Technology Track

Room 237-239

- 8 a.m. Implementation of Acoustic Inspection Technology  
at the City of Augusta
- 9:30 a.m. Highlights from the 7th Edition of Operation  
and Maintenance of Wastewater Collection  
Systems Manual
- 11 a.m. Technological Advancements Fulfill the  
Promise of Zoom Survey Paradigm

\*MSW - Municipal Sewer & Water

## Portable Sanitation Track

Room 136-138

- 8 a.m. Portable Sanitation - Special Events
- 9:30 a.m. Making Your Portable Restroom Business Lean  
and Mean – How to Boost Productivity and  
Increase Your Bottom Line
- 11 a.m. T.B.D.

## Treatment Plant Operator Track

Room 240-242

- 8 a.m. Utility Regulation Basics for Grease Haulers
- 9:30 a.m. The Waste in Our Wastewater
- 11 a.m. Security Issues and Best Practices for Water/  
Wastewater Facilities

## Pipe Rehab Track

Room 243-245

- 8 a.m. Integrating Temperature Sensor Technology  
within Lateral Pipeline CIPP Installations
- 9:30 a.m. CIPP Calibration and Vacuuming
- 11 a.m. Extending Life Expectancies with Corrosion-  
Resistant Coatings and Linings

## Business Track

Room 133-135

- 8 a.m. Team Building for Profit
- 9:30 a.m. Ten Commonsense Ways to Grow and  
Improve Your Business
- 11 a.m. Setting Expectations – The Key to Sales  
and Customer Satisfaction

## Advanced Onsite Installer Course

Room 234-236

8 a.m. - 5 p.m.

- Introduction and Site Evaluation
- System Sizing and Basic Design Principles
- Pumping to Systems
- Installations of ATUs
- Installing for Management
- Troubleshooting Systems

To register or for  
detailed information:

**wwett.com**  
**866-933-2653**

# Register Today and Be Entered to Win!

Register to attend the 2015 WWETT Show and you'll automatically be entered to win this Chevy 4x4!







THE VACALL

# FULL-COURT PRESS



**AllExcavate**



**AllJetVac**



**AllSweep**

Vacall slam dunks the competition with advantages our competitors can't (or won't) match. Whether we're digging, cleaning or clearing out sewer lines, we've got the right line-up.

Do your vacuum and jetting machines have...

- ▶ Standard CAN bus Smart Controls
- ▶ Single-engine cost savings
- ▶ Industry leading jetting and vacuum forces
- ▶ Lifetime warranties on aluminum water tanks and debris bodies
- ▶ Simplified operation



**AllCatch**



**AllVac**



LEARN MORE AND REQUEST A DEMO

VACALL.COM | 800-382-8302



# SPX



## P350 FLEXITRAX™ SYSTEM

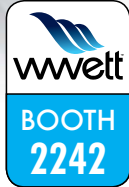

### TRULY PORTABLE CCTV CRAWLER INSPECTION SYSTEM

- **Outstanding picture quality:** Ultra-bright LEDs and high-resolution cameras built on a powerful digital video platform.
- **Versatility:** Build the ultimate, motorized or manual compact system that offers both pushrod (up to 500') and crawler (up to 1,000') capability, to suit a wide variety of your inspection needs.
- **Reliability where you need it:** Weatherproof construction that's designed to withstand the toughest conditions.
- **Flexible digital data transfer:** Access your survey data with Compact Flash cards, USB 2.0 or Bluetooth® wireless technology.
- **Serviceability:** Designed for continuous operation and easy maintenance on and off site.

To find out more call us on **+1 800 688 8094**, or email [crystal.machado@spx.com](mailto:crystal.machado@spx.com)  
[www.spx.com](http://www.spx.com) [www.radiodetection.com](http://www.radiodetection.com)



The Bluetooth word, mark and logos are registered trademarks of Bluetooth SIG, Inc. and any use of such trademarks by Radiodetection is under license.

## See Our Hoses

at



- And Ask Our Representatives About:**
- Jetting/Lateral Line Hoses,
  - Piranha® Standard High Pressure Sewer Cleaning Hoses,
  - Large Diameter Hoses Up To 1-1/2",
  - Piranha® Slither™ High Pressure Sewer Cleaning Hoses,
  - Piranha Armor Belt® Sewer Cleaning Hoses,
  - Twin/Multi Lines

Or for samples, literature and more information contact us at



**Piranha Hose Products, Inc.,**  
 Cadillac, MI  
**1-800-250-5132**  
[www.piranhahose.com](http://www.piranhahose.com)

## For Those Tight Places



# mini



Phone: 1.800.322.0510  
 E-Mail: [apc@apclsq.com](mailto:apc@apclsq.com)  
 Website: [www.arthurproducts.com](http://www.arthurproducts.com)



**ARTHUR PRODUCTS CO.**  
 an LSQ Mfg Company





**Designed** by you. **Built** for you.

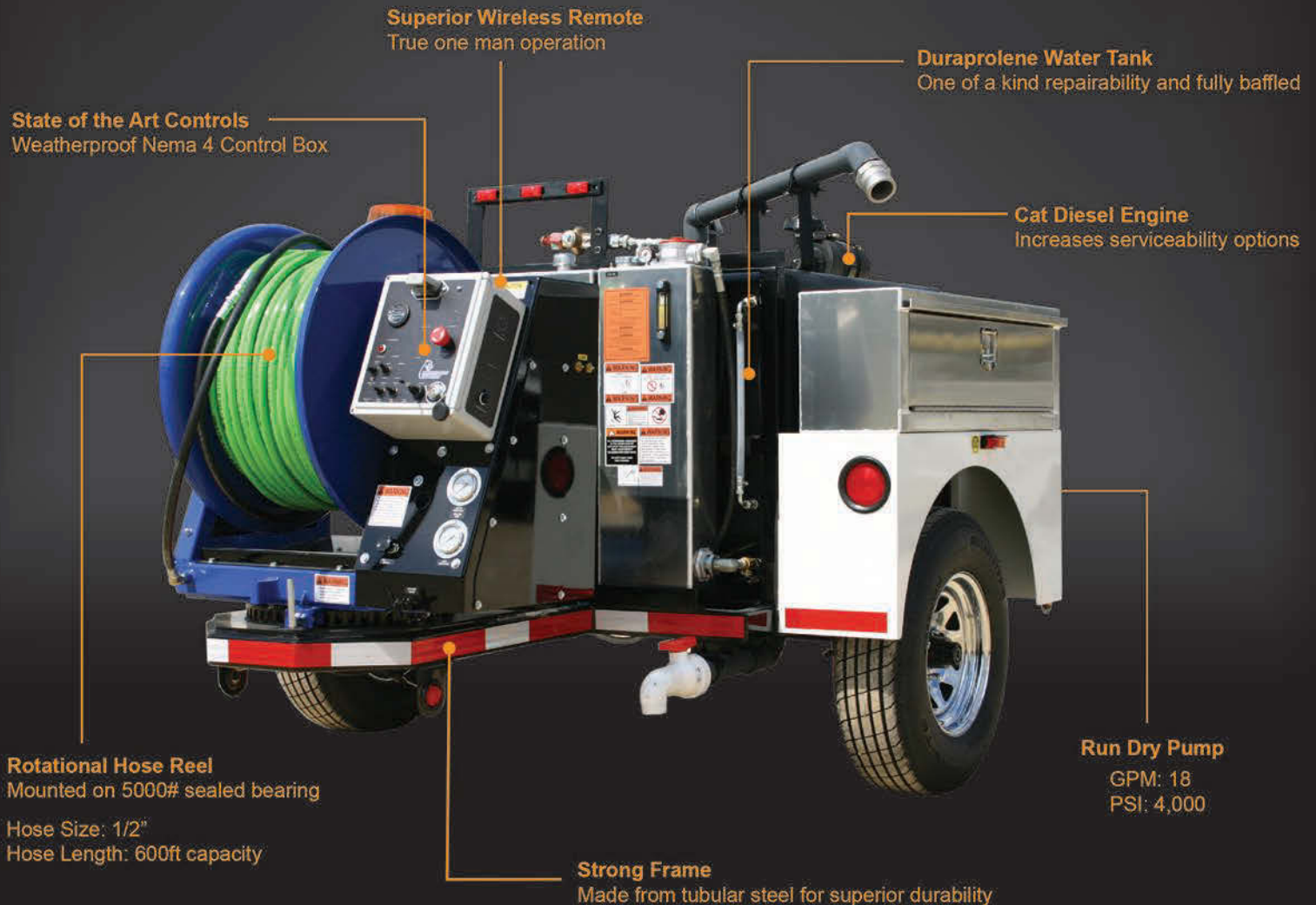

# MONGOOSE MODEL 184

*Other units and configurations can be found on [mongoosejettters.com](http://mongoosejettters.com)*

Everyone has a story to tell. At Mongoose, our story is quite simple. Our products are born out of the necessity to deliver a premium quality, long lasting product which in return will prove to be extremely cost effective and profitable for your business.

Is a manufacturer selling you an idea or image rather than a piece of machinery that's built to last? At Mongoose, we insist customers review our equipment in detail to see the quality of construction in every unit. There should be no doubt that a you are making the right decision when purchasing a Mongoose unit.



Working well under pressure!



## Pressure Washers and Drain Jetting Equipment

Skid and truck mount models up to 7000 psi



Portable Hot and Cold Water Diesel Powered Models



Hot and Cold Trailer Models  
Up to 7000 psi  
Flows up to 40 gpm  
Powered Reels  
Diesel powered models



We will custom build to your specifications  
www.camspray.com 800-648-5011



## World Health Organization talk slated for WWETT Show

The threat of communicable diseases is real for everyone who handles or comes in contact with wastewater. Understanding the risks and taking the necessary precautions is the key to protecting yourself.

Since the ebola virus outbreak in West Africa made headlines, many in the wastewater industry have asked about the potential for a variety of communicable diseases to spread through contact with human waste during the cleaning, maintenance and repair of sanitary drain and sewer lines.

Those questions will be answered at the 2015 Water & Wastewater Equipment, Treatment & Transport Show. Dr. Adrianus Vlugman, World Health Organization senior advisor on water, sanitation and environmental health, will speak Feb. 26 at 1 p.m. in Rooms 133-135 at the Indiana Convention Center as part of an extensive series of WWETT Show speakers and seminars.

Vlugman will provide a general overview covering the survival and life expectancy of communicable diseases in water and wastewater. Among other topics, he will cover:

- Safety precautions to consider when handling water and wastewater.
- The likelihood of communicable diseases to be spread or passed through both centralized wastewater plants and decentralized onsite wastewater systems.
- Whether there is a concern for the spread of communicable diseases through land application of properly treated sewage, biosolids or septage.

The talk on the transfer of communicable diseases is free and open to anyone.

**If you would like to attend the WHO program, fill out the online registration form at [www.wwettshow.com/who](http://www.wwettshow.com/who).**

Water & Wastewater Equipment, Treatment & Transport (WWETT) Show  
Feb. 23-26, 2015 | Indiana Convention Center, Indianapolis  
[www.wwettshow.com](http://www.wwettshow.com)

**ultra ultra ultra**  
**LIGHT – VERSATILE – SAFE**

# ultraSHORE

PRODUCTS





Quick to Install.  
As light as 130lbs.

Roll Your Own.  
Optional wheel kit.

Stacks easily with  
2' & 4' high panels.

**This is What Aluminum Shoring Was Meant to be!**



**1-800-SHORING**  
CALL TOLL-FREE NATIONWIDE • 1-800-746-7464  
[www.shoring.com](http://www.shoring.com)

1-800-683-8837



Uncover the truth  
about your underground utilities.



(800)-656-4225 | [www.rapidview.com](http://www.rapidview.com)





## ARM reduces risk, fatigue

The new ARM (Automated Remote Manipulator) from NLB lets an operator do a variety of high-pressure water jet jobs without leaving his seat. This semi-automated system reduces the risk of injury and:

- does a variety of jobs (with quick-connect tooling)
- operates at up to 600 hp and 40,000 psi
- combines long reach with a wide jet pattern
- has joystick controls in a climate-controlled cab.

With an ARM, water jet safety and productivity go hand-in-hand. For details, visit [www.nlbcorp.com](http://www.nlbcorp.com) or call 800-441-5059.



**NLB Corp.** The Leader in Water Jet Productivity

29830 Beck Road, Wixom, MI 48393  
 MI: (248) 624-5555, IN: (219) 662-6800, NJ: (856) 423-2211  
 LA: (225) 622-1666, TX: (281) 471-7761, CA: (562) 490-3277  
[www.nlbcorp.com](http://www.nlbcorp.com) • e-mail: [nlbmtg@nlbusa.com](mailto:nlbmtg@nlbusa.com)

## YOUR SOURCE FOR RIDGID



LT1000 Laptop Interface System



CS10 Digital Recording Monitor with Flash Drive



microDrain Reel

SeeSnake® Compact 2 Camera Reel



DVD Pak



CS6 Digital Recording Monitor



SeeSnake® MAX rM200 Camera System

## CENTRAL OKLAHOMA Winnelson COMPANY

**8% ONE YEAR FINANCING AVAILABLE!**  
 Longer lease rates also available. Call Keith for details.

**BUYING A SEESNAKE?**

**CALL KEITH  
FOR SHOW  
SPECIALS**

**WE  
WILL NOT BE  
UNDERSOLD**

**FREE SHIPPING!**

**- Call Us Evenings and Weekends -**

**Keith: 405-602-9155 &**

**Jim: 405-205-3974**

**CALL TOLL FREE: 888-947-8761**

5037 NW 10th  
 Oklahoma City, OK 73127

[www.centralwinnelson.com](http://www.centralwinnelson.com)



# Engineered for **Easy**



## **endura** XL Grease Interceptor

Performance      Functionality      Longevity

Building on more than a decade of field proven success with our Endura grease interceptors, the **all-new Endura XL Grease Interceptor** marks a step change in grease interceptor **performance** and **functionality**. The upcoming introduction of the Endura XL75 and XL100 brings to the market the product **longevity** that the industry has come to demand but, additionally **XL is designed from the ground up to meet the corporate priorities and operational needs of all the major users, including you the maintenance and pumping professional.**



[www.EnduraXL.com](http://www.EnduraXL.com)



Booth #1220

**canplas**<sup>®</sup>

an OAlaxis company



# Predicting Safe Outcomes

A new approach to accident prevention goes beyond the traditional principles

By Doug Day

Anyone involved in safety is familiar with Heinrich's Law: For every 330 incidents, there will be 300 with no injuries, 29 minor injuries and one major injury. While the accuracy of his theory is questioned, the principle seems sound enough — minor incidents lead to more serious ones.

Heinrich did his work in the 1930s using data from the '20s. That's nearly a century ago, long before we had the power to crunch "big data" to reveal unseen patterns and trends. "In the last 20 years the number of injuries in the U.S. has steadily declined," says Griffin Schultz, general manager of Predictive Solutions in Pittsburgh. "Fatalities and significant injuries have flatlined."

He adds that companies are finding the theory that smaller injuries predict larger ones isn't necessarily true. "They're also finding that precursors to significant injuries and fatalities are different than precursors to less severe injuries."

Predictive Solutions, a global safety and predictive analytics company, uses safety observations rather than actual incidents to predict the future. "Injuries are on the far right of the spectrum. That's what happens at the end; a wrench falls off scaffolding and hits someone in the head. A near miss is one step to the left; a wrench falls and doesn't hit anyone."

That is the typical scope of safety analysis based on Heinrich's Law and leads to answers about what, where and how incidents happen. "Those are lagging indicators — looking backward," he says.

"Further to the left are safety observations," he says. "You see a wrench on scaffolding and there's no toe rail to prevent it from falling. That's the data we use to predict injuries."

Predictive analytics, used for years in sales and marketing, finance, maintenance and other business functions, looks ahead to answer questions such as why things are happening and what's going to happen next; moving from lagging indicators to leading indicators.

The company analyzes data from the entire base of customers using its SafetyNet software, including some leading gas and oil companies. Its 170 million safety observations are growing by 3 million per month.

Using computer analytics, the observations predict workplace injuries at an accuracy rate of between 80 and 97 percent, determined by comparing actual incidents to the number predicted. The company cites these examples of how analytics have helped companies:

- A Fortune 150 manufacturer reduced its lost work day rate by 97 percent within one year.
- A Fortune 150 energy company reduced its incident rate by 67 percent within 18 months.
- A top 20 construction company achieved significant safety improvements including 90 percent of work sites experiencing no lost-time incidents.
- A top 10 specialty contractor reduced its workers' compensation fees by 57 percent and 66 percent in two years while the number of hours worked increased.

"It's no different than quality," adds Schultz. "Testing a product at the end of the assembly line is one measurement. You want to catch the defect in the steps of the process, not at the end. It's the same thing in safety. You want to observe every day to make sure the toe rail is installed so that wrench never has the opportunity to fall off the scaffolding." **c**

## THE FOUR TRUTHS OF SAFETY

Looking at four years of safety data while building its analytical tool, Predictive Solutions found that those projects with the fewest safety incidents had several things in common. Two are what safety professionals have known for many years:

- Too many unsafe observations predicts an unsafe work site: Commit time and resources to fixing observations before they cause incidents.
- More inspections predict a safer work site: Make sure your program rewards high levels of inspections.

**Predictive Solutions also found two that are more counterintuitive:**

- More inspectors, specifically more inspectors outside the safety function, predict a safer work site: Include as many people as you can in your safety inspection program and ideally, have more nonsafety than safety people doing inspections.
- Too many "100 percent safe" inspections predict an unsafe work site: Train for and reward the reporting of unsafe observations.

From the white paper *Predictive Analytics in Workplace Safety: Four 'Safety Truths' That Reduce Workplace Injuries*  
[www.predictivesolutions.com](http://www.predictivesolutions.com)



# World class sewer cleaning units

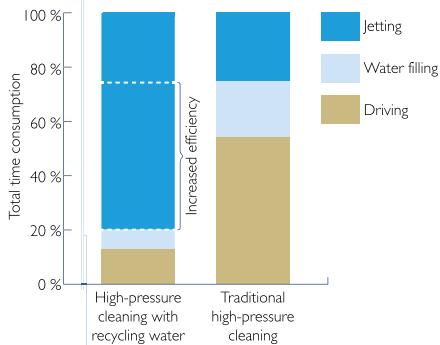

## Save Water, Time and Fuel

In our RECYcler, the jetting water is cleaned and reused for jetting. The process is fully automatic, 100 percent continuous, and it requires nothing more of the operator than with a traditional combination unit. Our RECYcler unit is at least 60 percent more efficient than a traditional combination unit, when assuming equal capacities.

Meet us at booth 6325  
**WWETT Show 2015**

## J. Hvidtved Larsen – Expanding in the US

Since 1915, we have specialized in the development and manufacturing of sewer cleaning vehicles and vacuum loaders for all imaginable conditions and tasks.

Our units have made their mark through uncompromising quality down to the smallest detail with sophisticated, intelligent technology and solutions.

**We are presently expanding our US operations and are looking to fill positions in our US-based subsidiary to further establish J. Hvidtved Larsen as the leading provider of highly advanced sewer cleaning vehicles. Please visit us at WWETT show or our web page at [www.hvidtved.com](http://www.hvidtved.com).**

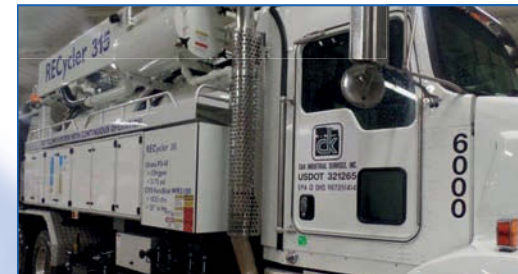

RECYcler delivered to C/K in Cleveland



60% more efficient than traditional combination units



**J. Hvidtved Larsen US**



# THE ELECTRIC EEL® MODEL C DRAIN & SEWER CLEANER...

## BEATS THE DRUM!

### TRIED & TRUE, BETTER THAN NEW...

#### This Powerful Sectional Drain Cleaner Outperforms Drum-Style Machines

- Redesigned Quick-Connect Snap-Lock Cable Couplings
  - No Down Time From Broken or Kinked Cables
  - More Power and Twice the RPMs
  - Less Cable and Tool Breakage
  - 8' & 10' Sectional Cables
  - Easy Transport By One Person
  - Lower Maintenance and Much More
  - All For \$100's Less!
- Don't Miss A Beat... Call Today!**



**wvett**  
BOOTH  
4156

# Electric Eel®

1-800-833-1212 [www.electriceel.com](http://www.electriceel.com)  
DRAIN CLEANING TOOLS FOR PROFESSIONALS



Fold down handle allows easy transport, storage and use in crawl spaces.

Cleans 3"-10" diameter lines up to 200 ft.

Redesigned **Quick-Connect** snap-lock cable coupling allows cables to connect easier and quicker than ever. Now standard on all Electric Eel® sectional dual cables, regular and heavy duty, and totally compatible with all cables currently in use.



PATENT PENDING

## Petersen® Pipe Plugging Systems



Pipe Plugs and Packers for all your Pressure, Chemical, and Temperature Requirements. Call us to quickly customize a pipe plug or plugging system for your specific application.

**wvett** BOOTH 2014

#### Economical Hot Tap Plugging Systems

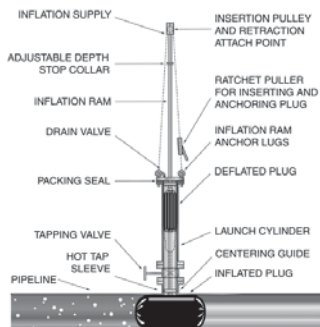

[www.pipeplug.com](http://www.pipeplug.com)

**Petersen** PRODUCTS COMPANY  
Serving Professionals Since 1916

PHONE 800.769.4973 OR 262.692.2416  
FAX 800.669.1434 OR 262.692.2418

## KEN-WAY Beats the Others DAY-IN • DAY-OUT

And they have for over 50 years

### KEN-WAY CABLE CLEANERS

for cleaning sewer, drain or process lines from one to ten inches, up to 75 feet with the Junior and up to a full length of 300 feet with the Model 400



### KEN-WAY Exclusive Built Cables

- Heat Treated
- Inner-Core or Non-Core
- Fit Most Other Brands
- Interchangeable with Most Brands
- Coupling or Blade Holding Types



Leasing plans available. Call for details.

**1-800-533-0551**

930 ROBERTS ROAD, SPARTA, WI 54656  
[www.ken-way.com](http://www.ken-way.com) • E-mail: [info@ken-way.com](mailto:info@ken-way.com)





# THE BETTER JETTER

**ENGINEERING. INNOVATION. QUALITY.  
PERFORMANCE. RELIABILITY. DURABILITY.  
SIMPLICITY.**



**wwett**

FEBRUARY 23-26  
INDIANA CONVENTION CENTER  
INDIANAPOLIS

2015

**BOOTH:  
5334, 5335**

## **WHO SAYS YOU CAN'T TEACH AN OLD DOG NEW TRICKS?**

2015 IS GOING TO BE A BIG YEAR FOR US JETTING. IN BUSINESS FOR 24 YEARS, US JETTING HAS SET A HIGH STANDARD OF EXCELLENCE AND IS AN ICON IN THE JETTING INDUSTRY AROUND THE WORLD. OUR MISSION IS SIMPLE: TO BE THE BETTER JETTER. NOT ONLY ARE WE MAINTAINING OUR HIGH STANDARD OF EXCELLENCE, WE ARE STEPPING IT UP!

WITH NEW TECHNOLOGICAL ADVANCES AND OUR INNOVATIVE MINDSET, WE ARE ENGINEERING HIGHER QUALITY, MORE RELIABLE AND DURABLE EQUIPMENT TO HANDLE ANY JETTER JOB WITH PRECISION.

**WE'LL SEE YOU AT THE SHOW!**



[WWW.USJETTING.COM](http://WWW.USJETTING.COM)  
[SALES@USJETTING.COM](mailto:SALES@USJETTING.COM) | 1-800-538-8464



## PRODUCT SPOTLIGHT

### Spider cutter cleans as it enters and leaves pipes

By Ed Wodalski

The Spider cutter from General Pipe Cleaners features front and rear blades. Cutting starts as the cable feeds into the line and continues as it retracts. A prime application for the tool is cleaning pipe walls prior to lining.

“With the blades going in both directions, it doubles the efficiency of the cutter,” says Marty Silverman, vice president of marketing for General Pipe Cleaners. “It does a better job of clearing the line and it does it faster.”

The tool is available in two models (double U-cutter and double heavy-duty side cutter) and two sizes. The 3-inch size is designed for cleaning 4- to 6-inch pipes and the 4-inch size is made for cleaning 6- to 8-inch lines.

“The Spider cutter is designed to scrape the walls of the pipe more efficiently,” Silverman says. “You would probably use it as a finishing



tool after you cut through the stoppage with your root cutter. Because the blades are on the side, it’s ideal for cutting root hair and scraping the walls of the pipe clean.”

Made of 1/8-inch hardened spring steel and coated for rust protection, the cutter can be adapted to sectional machines or other brands of cable-type drain cleaners for use in a variety of pipes, including plastic and cast iron. 800/245-6200; [www.drainbrain.com](http://www.drainbrain.com).



1



2



3

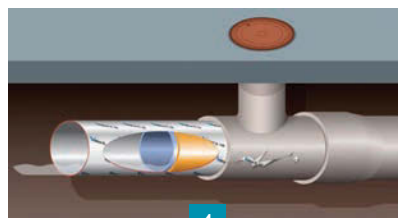

4



5

#### 1 NLB SELF-ROTATING WATERJET NOZZLE

The RPN4009 self-rotating waterjet nozzle from NLB Corp. cleans pipes and tubes at pressures up to 40,000 psi (2,760 bar). Designed for a minimum pipe diameter of 0.75 inches (1.91 cm), the nozzle is coated with titanium nitride for long life and is available with cutting/cleaning or polishing heads. The nozzle is 4 3/4 inches long (12.1 cm), has a maximum flow of 9 gpm and rotates at 7,000 rpm. 248/624-5555; [www.nlbcorp.com](http://www.nlbcorp.com).

#### 2 STONEAGE ROTARY TUBE CLEANING NOZZLE

The BN15 Banshee rotary tube cleaning nozzle from StoneAge reduces the jet standoff distance in tubes and provides harder hitting power for 3/4-inch tubes. The BN15 has a tube I.D. range of 0.75 to 1.2 inches, maximum pressure of 22,000 psi and flow range of 7 to 10 gpm. The nozzle is 3 inches long and 0.6 inches in diameter. 866/795-1586; [www.stoneagetools.com](http://www.stoneagetools.com).

#### 3 JENNY VERTICAL TANK STATIONARY COMPRESSORS

Electric two-stage, vertical-tank, stationary air compressors from Jenny Products provide 175 psi and displace between 9.1 and 43.6 cfm. Each compressor has a heavy-duty, two-stage cast iron pump and powder-coated

ASME tank. Tank sizes include 60, 80 and 120 gallons. Options include airline filter, oil sight glass, low oil level switch and control circuit transformer. 814/445-3400; [www.steamjenny.com](http://www.steamjenny.com).

#### 4 VALERON SEWAGE PIPE REHABILITATION PRE-LINER

The Valeron IL pre-liner for CIPP rehabilitation from Valeron Strength Films, a division of Illinois Tool Works, is designed to prevent water in the soil from entering the liner. It also shields the environment from non-cured resins used in the hardening process. The pre-liner can be inverted by pressurized air or pulled into place and is suitable for deviating pipe shapes (oval). 800/825-3766; [www.valeron.com](http://www.valeron.com).

#### 5 KENCO CONCRETE BARRIER LIFT

The barrier lift from KENCO Corp. can be used on any concrete median barriers, sound walls, curbing and piling. Fully automatic grab-and-release action allows for hands-free operation. The 6- by 36-inch elastomer pads grip sidewalls, even in wet conditions. Pad angles swivel to match the slope of the wall to be lifted. Capacities range from 1,500 to 40,000 pounds. Self-aligning guides are available. 800/653-6069; [www.kenco.com](http://www.kenco.com).

CONTINUED >>



# ALLAN J. COLEMAN

## SINCE 1905

Call us today!  
773-728-2400

5725 North Ravenswood Avenue • Chicago, IL 60660 • [info@allanjcoleman.com](mailto:info@allanjcoleman.com) • [www.allanjcoleman.com](http://www.allanjcoleman.com)

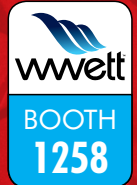

**CALL FOR  
GENERAL  
SPECIALS**

Special pricing  
on all  
General jetters,  
cameras and  
machines



### Warthog® Nozzles



**Repair Center for: RIDGID SeeSnake, Gen-Eye, Radiodetection, Electric Eel, Vision Technology, Insight Vision & Spartan Cameras Fast Turnaround Time**

## UPGRADE your camera system to the GVISION. A Better System



Visit [www.eplsolutions.net](http://www.eplsolutions.net)  
for more details.

### GVISION

Gvision V3 is a universal monitor capable of recording from a variety of camera reels. View the screen in the blaring sunlight or in the shade with no visible difference.

This ruggedized monitor records onto flash drives, hard drives, and an iPhone®, iPad®, or iPod Touch®. Connect to the A/V in/out connector to use DVD-RECs and other compatible recorders.



Ask what the  
**GPLAYER**  
can do for you?



JetSonde Carriers - P-Trap Cable Sonde Carriers

**Turn ANY push camera into a Jetter Camera with the JetCam Adapter.**



A specialized sonde for locating cast iron and non-metallic pipe 20+ feet deep.



JetCam Adapter

JetSonde Nozzle

Jetter Hose

**OLDEST NAME IN THE BUSINESS**  
**— Over 100 YEARS OLD —**

PHCC MEMBER





6

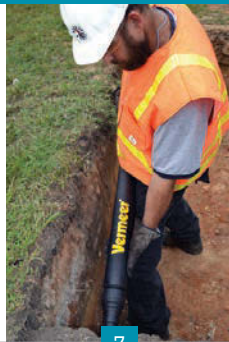

7



8



9



10



11



12



13

**6 WASTEQUIP LOCKABLE ROLL-OFF CONTAINER COVERS**  
 Lockable roll-off container covers from Wastequip are designed to meet EPA regulations for stormwater exposure. Made of UV-protected, impact-resistant high-density polyethylene, the covers open to 90 degrees and are permanently mounted to the container. The covers are available in multiple sizes and configurations. **877/468-9278; www.wastequip.com.**

**7 VERMEER HOLE HAMMER PIERCING TOOLS**  
 The Vermeer VPT 250 Short model Hole Hammer piercing tool from McLaughlin is made for work in tight areas. The tool has a positive-turn reverse design with short body, enabling contractors to dig a concise entry and exit pit for a more effective job site and less impact on surrounding neighborhoods. Available in 2-, 2.5-, 3- and 4-inch diameters, the 2.5-inch-diameter tool is 35 inches long and delivers 720 blows per minute. **864/277-5870; www.mclaughlinunderground.com.**

**8 REELCRAFT PRESSURE-WASH HOSE REELS**  
 Pressure-wash hose reels from Reelcraft are rated to 5,000 psi. Designed for heavy-duty use, the hand-crank Series 3000 holds up to 450 feet of 3/8-inch I.D. hose or 325 feet of 1/2-inch I.D. hose. **800/444-3134; www.reelcraft.com.**

**9 PEERLESS ELECTRONICS BUBBA II SERIES CONTACTORS**  
 The TE brand KHR500 (BUBBA II) contactor distributed by Peerless Electronics is a size-reduced version of the Kilovac BUBBA series. Weighing less than 2 pounds, it has 600 amp carry, SPST main contact and SPDT auxiliary contacts. Other features include bidirectional load switching and 3,300 amp break at 400 VDC. **800/285-2121; www.peerlesselectronics.com.**

**10 LOWELL PIPE WRENCH HEAD ADAPTER**  
 The pipe wrench head adapter from Lowell Corp. can be attached to a breaker bar, torque wrench or other tool with a 1/2-inch male drive. The steel wrench weighs 3 1/4 pounds and has 280 ft-lbs torque capacity. Jaws open from

1 1/2 to 5 1/4 inches. When used with a ratchet, the tool's stop bar prevents unwanted ratcheting during repositioning. **800/456-9355; www.lowellcorp.com.**

**11 GUZZLER VACUUM LOADER CHASSIS OPTIONS**  
 The Guzzcavator multipurpose vacuum truck and NX, NL vacuum loaders from Guzzler Manufacturing are available with Kenworth T880 and Cat CT660 Class 8 model chassis. Shorter bumper and axle settings on the Kenworth chassis provide a tighter turning radius and greater maneuverability. The Cat CT660 chassis is built for operator comfort and features a sloped hood, wraparound windshield, heated mirrors and halogen headlights. **800/627-3171; www.guzzler.com.**

**12 DITCH WITCH SK850 MINI SKID-STEER**  
 The SK850 mini skid-steer from Ditch Witch has a 37 hp Tier 4 Yanmar diesel engine, accepts attachments for a variety of underground construction tasks and has a 74-square-inch operator's platform. Dual-lever ground drive controls are standard with single-lever joystick available. An auxiliary control foot pedal helps operators maintain hydraulic flow to the attachment while freeing hands to control depth and ground speed. The unit has an 860-pound rated operating capacity, 83-inch hinge-pin height and 42- or 36-inch wide tracks. **800/654-6481; www.ditchwitch.com.**

**13 WATER CANNON VIRUS KILLER PRESSURE WASHER**  
 The 17M95 electric portable pressure washer from Water Cannon delivers 180-degree hot water (hot-water heater required at source) or ambient temperature water injected with 5.25 percent sodium hypochlorite (household bleach) and calcium hypochlorite (bleach powder). The application for 10 minutes on concrete, brick, stone or metal surfaces kills viruses. Accessories include 50-foot hose, trigger gun and wand, low-pressure wide-fan bleach, chemical or soap injector, four color-coded spray nozzles and color-coded chemical nozzle. **800/333-9274; www.watercannon.com. c**



GO MORE PLACES.  
DO MORE JOBS.



Visit us at **WWETT**,  
Booth #5214, Feb. 24-26, 2015,  
Indianapolis, IN

More options lead to more job opportunities. With the new Ditch Witch® FXT50, you can be as versatile—and profitable—as you want to be. It mounts on the single-axle truck of your choice, so you control your initial investment. You choose its tank configurations and decide on options such as reverse-flow, hydraulic boom and water heater. No matter how you build it, your FXT50 can get you to more places and help you do more jobs. **WE'RE IN THIS TOGETHER.**



## WHY BUY FORBEST

- Our products are the most easy devices to use and record with both USB and SD cards;
- Our products are reliable and the most affordable;
- We offer the lowest service cost and the shortest turn-around.

### Economic Color Sewer/ Drain Camera

FB-PIC3188/3188D-65

Specs:

- 65FT Cable & Reel
- Waterproof Color Camera Head
- 7" LCD Monitor w/ or w/o DVR & MIC
- Aluminium Case

Starting at  
**\$550**



### Layflat Pipe Inspection Camera

FB-PIC3588A/3588BT

- 7" LCD Control Station with Built-in USB Flash and SD Card Recorders and Li-Ion Battery
- 3/8" 150FT /200FT Cable & Reel w/Electronic Meter Counter
- Crawler for easier push
- 7/8" Stainless Steel Color Camera Head w/Built-in 512HZ Sonde Transmitter for 3588A (1.5" Self Leveling Head w/ Built-in 512HZ Sonde Transmitter for 3588BT)

**NEW**



### Pan-Tilt 360°/180° Camera System

FB-PIC36888

**NEW**

Specs:

- 400FT Cable & Reel w/Meter Counter
- Pan-Tilt 360°/180° Color Waterproof Camera Head w/Manual Zooming
- 7"/10" LCD Monitor w/DVR & MIC.
- Recording with USB Flash Drive & SD Card
- Crawler for easier push **Starting at \$5,190**



### Portable Color Sewer/Drain Camera

FB-PIC3188A/3188DN

Specs:

- 65FT/100FT/130FT Cable & Reel
- Color Camera Head
- 7" LCD Monitor w/ or w/o DVR & MIC
- Heavy Duty Waterproof Case
- Option 1: upgrade to Color Camera Head w/Built-in 512HZ Sonde Transmitter
- Option 2: upgrade to 130FT Cable & Reel w/Meter Counter **(New)**



### Mid-Range Pipe Inspection Camera

FB-PIC3388UT/3388MT

- 200FT Cable & Reel w/ or w/o Meter Counter
- Self Leveling Camera Head w/Built-in 512HZ Sonde Transmitter
- 10" LCD Monitor w/DVR & MIC
- Recording with USB Flash Drive or SD Card
- Heavy Duty Waterproof Case
- Crawler for easier push



### 512HZ Locator

FB-T2011-Locator

**NEW**

Specs:

- Frequency: 512HZ
- Operation Mode: NORM/NOISE
- Power Supply: 6\*AA
- Current: < 100mA
- Sensitivity: NEAR/FAR
- Continuous adjustable
- Output Intensity: LCD 15 levels



Promo Price:  
**\$499**

### Luxury Portable Sewer/Drain Camera

FB-PIC4188M/4188H

Specs:

- 130FT Cable & Reel w/ or w/o Meter Counter
- Color Camera Head w/Built-in 512HZ Sonde Transmitter
- 10" LCD Monitor w/DVR & MIC
- Recording with USB Flash Drive & SD Card
- Heavy Duty Waterproof Case



### Long Range Pipe Inspection Camera

FB-PIC3288T/3488T

- 300FT/400FT Cable & Reel w/Meter Counter
- Self Leveling Camera Head w/ Built-in 512HZ Sonde Transmitter
- 10" LCD Monitor w/DVR & MIC
- Recording with USB Flash Drive or SD Card
- Heavy Duty Waterproof Case
- Crawler for easier push



# Quik-Shot

www.quiklining.com

## CIPP AUTOMATION

Simplifying the lateral sewer line rehabilitation process through patented automation.



- » Reduce Material Costs
- » Reduce Labor Costs
- » Simple to Set Up
- » Simple to Operate
- » No extra material handling found in other processes
- » No need to pass on longer line rehabilitation
- » No sleepless nights worrying about failure



**CALL TODAY**

for the nearest training and support outlet facility to get you up and running.

**Quik-Lining Systems**

714-296-5262  
WWW.QUIKLINING.COM

This Is The Nozzle You've Been Waiting For

\*Patented  
**Root Rat** root cutter nozzle

1/2"



7-35 gpm/1500-10,000 psi

3/8"



3-10 gpm/2000-7500 psi

3/4-1"



40-160 gpm/1500-4000 psi

### Custom Built Jetters



Hot or cold water jetters from 4 gpm at 4000 psi to 12 gpm at 4000 psi, skid or cart frames or small trailer systems.

### Root Rat Combo Kit

"The Root Rat is the easiest and most versatile root cutter nozzle I have ever used. The Root Rat works where other nozzles fail."  
Tim Jones, owner of Eastern Sewer Jetting



3/4" - 1" root rat combo kit. Use a reducer adapter to go from 1" to 3/4".



MADE IN THE USA

WE SELL AND SERVICE COLD WATER JETTERS

We Sell PARTS, PUMPS, UNLOADERS, HOSES, JET TIPS, ETC.

Visa, Mastercard, Discover, AmEx Accepted

**CHEMPURE PRODUCTS CORP.**

1-800-288-7873 • 330.874.4300

www.rootrat.net





# hydraX



U.S. Patent Pending

## HALF THE SIZE, **TWICE** THE RANGE



**Hydra X** is the Xtreme Pad Dragon you need to safely and effectively clean hard-to-reach areas. Operators control rotation speed and range of motion inside a climate controlled cab with blast shield. Our innovative head design is half the size of competitors and offers twice the range reaching a full 180 degrees right to left and a full 180 degrees up and down at 90%. Our industry leading high-pressure hose management system keeps lines free and clear. Hydra X is the safest form of water blasting allowing for increased job productivity and less worker fatigue.

- > Full 180 degrees right to left
- > Full 180 degrees up and down at 90%
- > Climate controlled cab with blast shield
- > Variable rotation speed control
- > Quick change system with multiple tools
- > Industry leading high pressure supply hose management system
- > Default high pressure dump
- > Max PSI 20,000 (1379 Bar)
- > Max GPM 100 (378.5 Liters)
- > Up to 605 HP
- > Max Blast 20'

AQUABLASTERS.COM

866-362-9332





put some  
**FERT**  
on that  
**DIRT**



MEC / P  
MEC II 9000

800-1400	320	27	30
RPM Range	Air Flow Max (CFM)	Intermittent Vacuum Max	Intermittent Pressure Max
2.5 qts.	3"	289 lbs.	
Oil Tank Capacity	Porting Size (NPT)	Weight	



Battioni®  
Pagani  
Pompe



**NORTH AMERICA**  
First Choice When Quality Matters

ThomasC@ARNorthAmerica.com • 1.800.893.4235

Come visit us in Indiana at

**wwett**  
booth #1211

## INDUSTRY NEWS

### Aquam names head of research and development

Aquam Corp., parent company of Nu Flow Technologies, named Daniel Krywyj head of its research and development department. He will be responsible for locations in San Diego, Calif., and Derby, United Kingdom.

### Advanced Drainage Systems opens distribution yard

Advanced Drainage Systems opened a stocking/distribution yard in Alviso, Calif. The facility is the third California location for ADS.



### Hino Trucks names service skills winner

Matt Kieman of O'Connor Motor Co., Portland, Maine, won the Hino Trucks sixth annual National Service Skills Competition. The national event brings together master elite service technicians for head-to-head competition in simulated service-related situations.

### Nu Flow's water epoxy system receives ACS certificate

Nu Flow's potable water epoxy #7000 system received the ACS Certificate of Sanitary Conformity in France. The potable water system is used to restore water flow and prevent corrosion and pinhole leaks. The barrier coating also prevents harmful materials such as lead from leaching into the water.

### Exact Tools establishes repair, distribution center in Canada

Exact Tools established a warranty repair and distribution center in Canada. The Finland-based company named Quality Tool Repair of Saskatoon, Saskatchewan, its master warranty repair center for Exact's PipeCut saws in Canada. The company also established a distribution center in Simcoe, Ontario.

### Go to Parts names business development manager

Go to Parts, Wastequip's new aftermarket parts division, named Dean Rank business development manager. He will be responsible for business development and account management with dealers and end-users.

### MaxLite opens facilities in Anaheim

MaxLite opened a LEED-certified product assembly and testing facility in Anaheim, Calif. The 48,864-square-foot, \$7.5 million building is located in the Anaheim Concourse development at Ocean Circle. **c**

GET  
**EMAIL NEWS  
ALERTS** FOR  
**Cleaner**

Go to  
[cleaner.com/alerts](http://cleaner.com/alerts)  
and get started today!



# The Contractor's Package



**wwvett** BOOTH 2200

## Everything you need—one package.

Includes our Upright Electric, Jetter, and Video Inspect/Locate/Leak Detect packages shown.

- **M888** (for 3-10" lines) and **M661** (for 1¼" - 3" lines) cable machines
- **M30** (mainline) and **M20** (sinkline) jettors
- **NGX10** (for 3 - 8" lines) and **MSA-NG-PCAM** (for 1½" - 3" lines) Next Generation cameras
- And much more

MyTana is your ONE Source for all the tools the sewer and drain cleaning professional needs. *And* personal customer service to help you—in the shop or in the field.

# MyTana

**1.800.328.8170**  
**www.MyTana.com**

Made in the U.S.A.



Request your **FREE, FULL LINE** catalog today!  
1.800.328.8170



CABLE MACHINES • JETTERS • PUSH CAMERAS FOR MAIN LINES AND DRAIN LINES • LOCATORS • RELATED PARTS • ACCESSORIES  
Factory Direct Customer Service Competent • Polite • Clear (M-F 7am - 5pm CST)



# SAFETY SEWER DRAIN



- Safety Risk Reduced
- Professional Image
- Less Mess
- Contamination Reduced
- Pays For Itself
- Easy To Use



Scan this QR Code with your smartphone app reader to see a video on how to use this product.

Ingalls, Michigan

**906.753.4002**

[www.SafetySewerDrain.com](http://www.SafetySewerDrain.com)



Record Direct to USB with One Touch!

Choose From Three Reel Sizes



## Magnum DVR

The *Magnum DVR* Controller is one of the simplest and easiest recording devices available on the market. Just turn it on and push record, it's that easy!

Eastern Canada 905-886-2835 -CALL- Western Canada 250-590-7927

[www.HATHORNCORP.com](http://www.HATHORNCORP.com)

Join A National Brand  
**ROOTERMAN.COM**

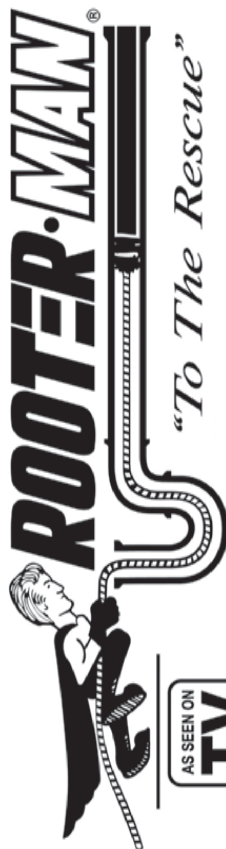

Without Paying the National Brand Price

**NEW CONCEPT: NO ROYALTY ON PERCENTAGE OF SALES**

**Reserve Your Exclusive Territory**

**Call 1-800-700-8062**

**FRANCHISE PACKAGE \$3,975.**

# Budget Friendly

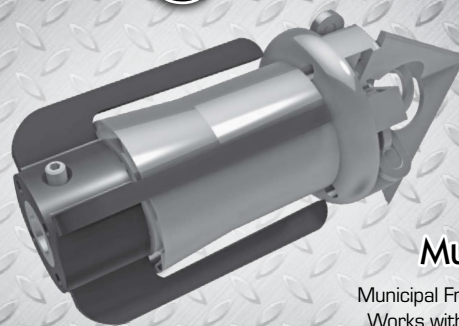

**NEW**

**Lumberjack®  
75 Series  
Municipal Cutter**

Municipal Friendly Cutter 4", 6" & 8".  
Works with 1/2", 3/4" and 1" Trucks.



**Equipment Engineered for Long Lasting Performance™**



CALL FOR A FREE DVD



**NozzTeq®**  
Taking Science to the Sewer!®

[www.nozzteq.com](http://www.nozzteq.com)  
Toll Free 1.866.620.5915

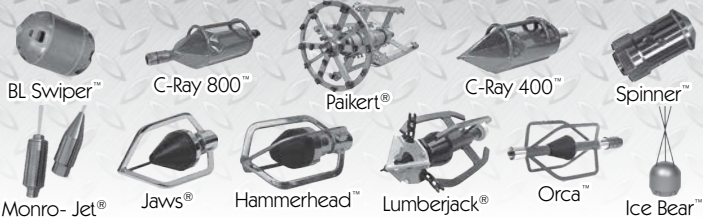



# LMK's Lateral Lining System Gives You Control!

The Performance Liner® Lateral System is a unique cured in-place process that allows the installer the freedom to position the liner anywhere in the pipe by inverting through an outside cleanout. Don't have an outside cleanout? No problem. You can trenchlessly install one using LMK's patented VAC-A-TEE® process.

LMK's lateral liners navigate bends and transitions easily, and the final product produces a smooth, tapered transition to the old pipe, allowing for maximum and improved flow rates.

Inversion tanks come in multiple sizes to accommodate 3 inch through 8 inch diameters and are equipped with a patented camera port so the liner can be visually inspected under pressure for proper placement prior to the liner being cured.

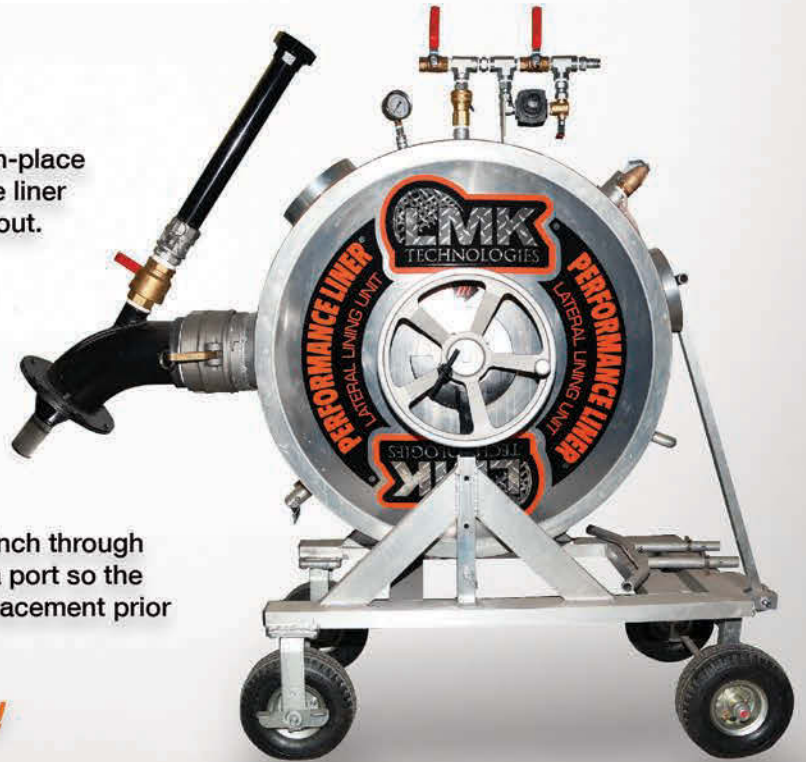

*Performance Liner – Puts You In Control!*

Leading Cured-in-Place  
Trenchless Products and Technologies  
for over 20 Years



Smart Cutter™

## PICOTE CUTTING SYSTEM AVAILABLE FROM LMK

- Utilizing a variety of hub sizes, the Smart Cutter reinstates CIPP service laterals from 1¼ inches to 8 inches in diameter.
- The Smart Cutter™ navigates 90° bends and diameter transitions effortlessly.
- The Twister System opens plastic or lined pipes quickly without damage.



Twister



To learn more about LMK's Performance Liner and Picote Cutter Systems  
visit [www.lmktechnologies.com](http://www.lmktechnologies.com) or call 815-433-1275.

**Attend Live Demos at WWETT and Register for a Daily Giveaway**



# **DR** DYNAMIC REPAIRS

**We Repair:**  
General Wire, Ratch, RIDGID, Hathorn Corp.  
Electric Eel, GatorCams, Vision Intruders  
and Vivax Inspection Cameras,  
Locators, Command Modules and Cables

**New & Refurbished Inspection  
Equipment For Sale**

**Rental Equipment Available  
Daily & Weekly Rates**

Ask About Our 48-Hr. Turn Around Time

## INSPECTION CAMERAS ARE OUR ONLY BUSINESS!

**973-478-0893**

**DYNAMIC REPAIRS**  
40 Arnot St., Unit 20  
Lodi, NJ 07644  
dynamiccablerepairs@yahoo.com  
www.dynamicrepairs.net

# Superior<sup>®</sup> SMOKE

For SEWER TESTING

Superior Smoke Fluid Systems  
Smoke Candles • Smoke Blowers

**MADE IN USA**

Superior Smoke Testing  
The Most Cost Effective Method to  
Find Sources of Surface Inflow

SuperiorSignal.com/Cleaner

**CONFINED SPACE  
ENTRY PACKAGE ONLY \$2,995**

**wwett BOOTH 2062**

- 4-Gas Air Monitor
- 7' Tripod
- 3-Way Fall Protection
- Work Winch
- Full Body Harness

Add a Blower with 15' of duct for only \$350!  
Add a 5 Minute Escape Respirator for only \$500!

**MECH. 800.362.0240**  
www.mtechcompany.com

## Water Jets for rent

**wwett BOOTH 1257**

- Units from 4,000 to 40,000 psi, including convertibles
- 60-600 hp, diesel or electric
- Rent, buy or lease
- 6 convenient branches: MI, IN, NJ, LA, TX, CA

**NLB Corp. 1-800-441-5059**  
www.nlbcorp.com

**You'll get friendly service when you let us repair your equipment**

**Electronic Repair Co. • 205-836-0454 • servicewithasmile.com**

- > We service push rod reels, cameras and command modules. We repair most brands.
- > We are an authorized service center for General Wire, Ratch, Vision and Ridgid.
- > We understand when your equipment is broken, you are losing Big Bucks! We give fast and quality service.
- > Your equipment is very expensive and we would be happy to supply references on our quality work. Just call Terry or Stan!

## T&T Tools, Inc. 800.521.6893

**CALL for a FREE Catalog**

Many styles Available

**wwett BOOTH 6000**

Insulated Soil Probes (for locating)      Heat-Treated Hooks (for covers, lids, etc)

www.mightyprobe.com

## HONDA ENGINES DELIVERED PRICE

- GX120QX - 4HP **\$375**
- GX160QX - 5.5HP **\$375**
- GX200QX - 6.5HP **\$399**
- GX270QAG - 9HP **\$579**
- GX390QA - 13HP **\$599**

Specify Red & White or Black

Un contacto en Español: llama al: **800.786.9274**

**GXPARTS.COM**

## You Can Install Sewer and Water Lines (Without Digging A Trench)

**Pipe Genies Do It All!**  
Ductile & Cast Iron, Clay & Concrete, ABS, PE & PVC

**Pipe Genies Pull Any Pipe!**  
System Power From 20 Tons to 240 Tons!  
(Rated for 1/2" - 30" Pipe)

**Pipe Genies Work Anywhere!**  
The Most Compact Systems Available!

We have everything you need to get started making profits with pipe bursting!

**www.TrenchlessAmerica.com**  
Toll Free 1 877 411 7473

## Waterblaster Rentals & Sales

Houston, Texas

**Boatman Industries**

1K to 50K psi  
60 hp to 1000 hp  
Waterblasters & Accessories  
Used Equipment Sales

**713-641-6006**  
www.boatmanind.com

Over 25 years of building quality equipment

# HotJetusa<sup>®</sup>

DRAIN LINE JETTING EQUIPMENT

## Most Versatile Jetter On The Market!

**wwett BOOTH 5540**

- 35 HP Vanguard
- Remote Control
- Cleans Drains from 2"-8"+

**On Sale For Only \$24,995!**

**Fully loaded! Call for details!**

**1-800-213-3272**  
www.hotjetusa.com

## Cua Claws

A Simple Solution for Slippery PVC Pipe -  
**The Right Wheels**

We now resurface all makes of steel transport wheels

**CALL JERRY AT 714-697-8697**  
www.cuaclaws.com

- BECOME MORE PROFITABLE
- NETWORK WITH PEERS
- WORK SMARTER, NOT HARDER

## Pumper & Cleaner PROFIT Series

**3 DAYS OF HANDS-ON  
BUSINESS BUILDING &  
NETWORKING**

**ORLANDO, FLORIDA  
GAYLORD PALMS  
MARCH 25-27, 2015**

**WWW.PUMPERPROFIT.COM**  
866-933-2653



**Factory Direct Special!** **FREE SHIPPING**

**WEDGE Service Replacement Tool**  
**Only \$495!**

Includes: Wedge, 75' cable & grip  
 3/4" & 1" copper connectors add \$99 • 3/4" & 1" PE connectors add \$99

Call us toll free: 1-888-737-3668



**DYE TRACERS**

**Solutions for:**

- Infiltration
- Septic Systems
- Cross Connection
- Leaks and more...

**BRIGHT DYES**  
 Division of Kingscote Chemicals

NSF Certified to ANSI/NSF 99

www.brightdyes.com • 1-800-394-0678



**THE "ORIGINAL" LIQUID SMOKE**

**Turbo Fog M45:**

- Versatile
- Light Weight
- Compact
- Creates Dense Smoke

**TURBO-FOG**  
 Since 1977

www.turbo-fog.com • 1-800-394-0678



Join A National Brand: [www.RooterMan.com](http://www.RooterMan.com)

**ROOTER-MAN**

*"To The Rescue"*

NO ROYALTY ON PERCENTAGE OF SALES  
 Franchise Package \$3,975

RESERVE YOUR EXCLUSIVE TERRITORY • Call 1-800-700-8062



**ERICKSON Tank & Pump**

**WE TAKE TRADES**

509.785.2955  
 CALL FOR UPDATED LIST OF EQUIPMENT

[WWW.ERICKSONTANK.COM](http://WWW.ERICKSONTANK.COM)

**Masport®**  
 PUMPS & QUALITY COMPONENTS

800 Rd. P.5 S.W. / Quincy, WA 98848  
 fax: 509.785.3770  
 e-mail: [sales@ericksontank.com](mailto:sales@ericksontank.com)  
 "TANKS" FOR YOUR BUSINESS!



Let Us Build Your **JETTER**

**Diesel Propane Gas**

**AMERICAN JETTER.COM**  
 866-944-3569

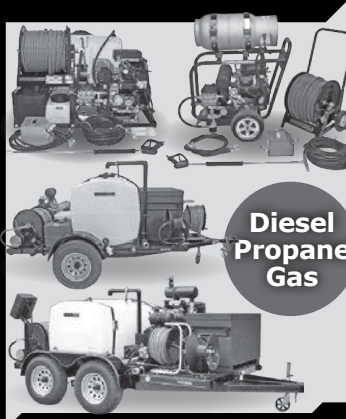

**PRIMELINE PRODUCTS, INC.**

*"Your Prime Source for Solutions, Products, and Training"*

**Quik Shot Gun** **Quik Heater**

**Primeliner™ QuikShot**  
 Fastest Lateral Lining Gun in the World!

- Installation Of Unlimited Liner Lengths
- Ambient Or Hot Water Cure With Quik Heater
- Financing Available

wwelt BOOTH 6400

**Primeliner™ CIPP Sectional Lining Materials**

Save up to 75% off Kit Pricing!

- FiberGlass With Felt Scrim
- Epoxy Resins - Silicate Resins
- Carrier Packers

**FREE Training from Experienced Personnel**

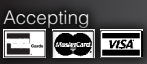

**24/7 Customer Support**

Call Us Today!! **407.772.8131**  
 or **877.409.7888**

Accepting 

Visit our Website: [www.primelineproducts.com](http://www.primelineproducts.com)  
 Facebook.com/PrimeLineLining

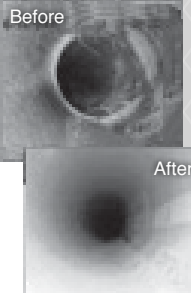
**You Tube** See for yourself!! See our Youtube channel  
[www.youtube.com](http://www.youtube.com) keyword: PrimeLineLining



# COAST MANUFACTURING

Professional-Grade Drain Cleaning Machines, Cables & Accessories



## Drain Cleaning Machines

- ▶ Heavy duty construction
- ▶ The most powerful motor in the industry
- ▶ Quick and easy reel changeover
- ▶ A one year rock-solid warranty



## Cables

- ▶ Fabricated from high quality wire
- ▶ Most ends & couplings available
- ▶ All sizes and lengths
- ▶ Innercore available

COAST MANUFACTURING

[www.coastmanufacturing.com](http://www.coastmanufacturing.com)  
1.800.541.7015

# LAPLACE EQUIPMENT

RENTALS, SALES & SERVICE

- **WATERBLASTERS:**  
PRESSURE TO 40K,  
FLOW TO 100 GPM
- WATER JETTING TOOLS
- HYDRO-MOWERS
- 3D NOZZLES
- ROTATING NOZZLES
- HIGH PRESSURE HOSES
- LANCES
- FITTINGS
- TIPS
- SUPPLIES
- EXPERIENCED TEAM  
FOR PLANNING,  
TRAINING & SETUP

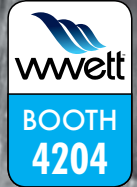

CALL  
985.652.5210  
FOR YOUR  
WATERBLAST  
PROJECT  
SOLUTIONS  
[WWW.H2OBLAST.COM](http://WWW.H2OBLAST.COM)

## BUYING SOMETHING?

## SELLING SOMETHING?

## LOOKING FOR SOMETHING?

We have **some things** and more

in the **CLASSIFIEDS.**

Check it out in each issue of *Cleaner* magazine or go to [www.cleaner.com/classifieds](http://www.cleaner.com/classifieds)





# All-In-One STEAM TRUCKS

Custom Built Steam and Hot Water Trucks For Sale, Lease or Rent.



- 150 HP Steam Generator
- 750 CFM Air Compressor
- 25 KVA - 3 Phase Generator
- Chemical Injection System
- 1100 Gallon Fresh Water Tank



- Enclosed Control Room
- 24' Enclosed Body
- 3 Side Roll-up Doors
- 160 Cubic Feet Of Storage
- Underbody Hose Storage
- Water Softener System

See Our Full Product Line & Watch Videos at [www.cipp-services.com](http://www.cipp-services.com)

# All-In-One AIR INVERTERS



## Continuous Air Inversion No Deflation To Steam Cure



- Units Available For 3" to 72" Diameter CIPP Liners.
- Apply Heat Within Minutes After Inversion
- Pressurized Internal Gland Lubricating System On All Units
- Rental Units Available
- Professional Training & Support

Small Diameter Lining Equipment & Materials



Phone: 815-712-8708 • E-mail: [sales@cipp-services.com](mailto:sales@cipp-services.com)



## BUSINESSES

**www.RooterMan.com.** Franchises available with low flat fee. New concept. Visit website or call **1-800-700-8062.** (CBM)

## COMPUTER SOFTWARE

FreeServiceReminderSoftware.com, FreeServiceDispatchSoftware.com, FreeRouteManagementSoftware.com. (C02)

## DRAIN/SEWER CLEANING EQUIPMENT

Used and rebuilt cable machines in stock: RIDGID K-7500, K-40, K-60, K-1500, Spartan #1064, #300, #100, Electric Eel model #C machines. The Cable Center: 800-257-7209. (CBM)

OBLITIROOT sewer line root killer. Triple the Dichlobenil (active ingredient) concentration. Buy direct from manufacturer for lower costs, higher profit margins. [www.olvidium.com](http://www.olvidium.com) 866-676-7956 (C02)

## HAZARDOUS WASTE UNITS

New 3,200 U.S. gallon, carbon steel, DOT certified 407/412 vacuum tank; dump type with full open rear door and a Presvac PVB-750 vacuum-pressure pump installed on a 2015 Peterbilt 348 cab and chassis. (Stock #13587C-E) [www.VacuumSalesInc.com](http://www.VacuumSalesInc.com), (888) VAC-UNIT (822-8648). (CBM)

## HYDROEXCAVATING EQUIPMENT



**2013 Storm Truck F3 Hydrovac:** 22k miles, 2,100 hrs. Blower 1,000 hrs. Water pump 500 hrs. Boiler 75 hrs. 2013 Western Star 500hp ISX15 w/18-speed. 1,500-gallon water tank. CAT Pumps - 3,600psi @ 25gpm water pump 6,875cfm @ 28". Robushi blower DV-145 875,000 BTU. Hotsy cold-weather package. 12v Pure Sine Wave inverter.

**Freedomrain@hotmail.com**  
**970-653-8588, CO** C02

## JETTERS-TRAILER



**Xtreme Flow Hot/Cold Jetter!** Model #HJ2TA8536, tandem axle trailer, 35 hp Vanguard 8.5 gpm @ 3,600 psi, 325-gallon water tank, 300' hose, General Pump. List \$34,995. On sale for \$29,995. Fully loaded!

**800-213-3272**  
**www.hotjetusa.com** CBM

2008 GMC PipeHunter: John Deere rear engine, 700-gallon poly water tank, 3/4" jet hose, Giant pump. Ken's Truck & Equipment: [www.khtrucks.com](http://www.khtrucks.com) 972-938-1905 or 214-632-5277 (CBM)



**2005 US Jetter - 4018 Hatz diesel,** 18gpm @ 4,000psi. Work ready, low hours. ....\$22,900

**800-627-0778** C02

2008 Ford PipeHunter: 7844TMV. 1/2" hose. Giant jet pump 14.2gpm @ 4,000psi. Tuthill blower, 1/2-yd. debris tank. John Deere rear engine. 294 hrs. Ken's Truck & Equipment: [www.khtrucks.com](http://www.khtrucks.com) 972-938-1905 or 214-632-5277 (CBM)

## JETTERS-TRUCK



**Pipehunter.com Jet Truck** (pre-owned) 4,000psi @ 20gpm. A great looking, operating and dependable piece of equipment.

**239-821-2596**  
**Rod@marcoplumbing.com** CBM

Jack Doheny Supplies Inc. offers a full range of late model combo units and DOT industrial vacuum loaders. Call us @1-800-3DOHENY. (CBM)



**1993 GMC 1-ton Jetter:** 35gpm FMC pump, 3/4" hose, 500-gallon plastic tank. ....\$14,500 OBO  
Other jet trucks and trailers available.

**608-835-7767, WI** PBM

## JET VACS



**2000 Vac-Con jet vac combo:** DT466 engine, 3-stage fan, Allison automatic, 52,000 miles. 600 ft. 1" hose new, 2,500psi @ 80gpm, 1,200-gallon water tanks, 12-yd. debris tank. Cummins rear engine, front & rear strobes, arrow board on rear. Hydraulic rear door, 40 ft. 8" tubes, debris body flush system. 8" telescoping boom. Excellent condition. ....\$69,000 OBO

**Call Mark 423-421-4347**  
**or Drew 423-290-4160, TN** C02



**2006 International Vac-Con:** 80gpm, 3-stage fan, 12-yd. debris tank, 90,829 miles, 1,031 hrs. Pony motor 1,960 hrs. ....\$135,000

**Call 877-389-2227, IN** C04

1998 Volvo GapVax: Stk# 2301, VIN# 4VHJCB JF8WN857157. Stainless steel tank, N-14 Cummins, 9-speed Fuller transmission, Roots 27" blower. Ken's Truck & Equipment: [www.khtrucks.com](http://www.khtrucks.com) 972-938-1905 or 214-632-5277 (CBM)

1991 Volvo Camel 200: Tandem axle. Great condition. Ready for work. \$25,000. Green Bay, WI. 920-655-7302 or 920-866-9109. (CBM)



**2003 Vactor 2112** (Sterling LT9501 Tandem) Excellent shape, Ex-municipal. Detroit diesel, 12-cubic-yard, 1,300 gallons, MultiFlow, tensioner/levelwind, hydroexcavation package. Call for price

**604-644-4498, WA** C02

2009 Sterling Vac-Con: VPD3616LHAEN SW: 09085083. 3,975 main engine hours. Bean jetting pump. Roots 824 RCS blower, 16-yard debris tank. New aluminum extension tubes. Hydraulic-driven jetter pump. Ken's Truck & Equipment: [www.khtrucks.com](http://www.khtrucks.com) 972-938-1905 or 214-632-5277 (CBM)

2002 Sterling LT7501 Vac-Con Model V390LHA combination sewer cleaning truck: Freshly painted white. CAT 3126 - 275hp engine, 3-stage fan, 1,000-gallon water tanks, pump off option available. 10' telescopic boom. FMC water pump - 65gpm @ 3,000psi. Articulating hose reel with 600 feet of new 1" hose. 84,316 miles. Located in Orange, CA. \$79,900. Contact Craig: 714-639-8352. Additional details at [www.empireequip.com](http://www.empireequip.com) (CBM)

1999 Freightliner w/Cummins M-11 350hp. Allison HD 4060, 64,000 GVV Guzzler combo unit w/stainless water and debris tanks. Extendable & rotating hose reel, extendable boom. Roots 824PD blower, Meyers pump, 80gpm. Ready for work. Photos available. \$58,000. 708-878-8401 (C03)

2007 Mack Guzzler: Damaged, rear unit new in 2011. Ingersoll Rand Air Solutions Hibon model SIAV 8702 blower. Ken's Truck & Equipment: [www.khtrucks.com](http://www.khtrucks.com) 972-938-1905 or 214-632-5277 (CBM)

2002 International Guzzler: 54,000 miles, 10-speed, 27" Roots blower. Stainless steel tank. Stk# 2300. Ken's Truck & Equipment: [www.khtrucks.com](http://www.khtrucks.com) 972-938-1905 or 214-632-5277 (CBM)

2006 International Vactor 2112V15: 9,300 hours, SW: 05-07V-9443, Vactor jet pump 80gpm @ 2,000psi. 600' 1" new hose. 800' hose reel capacity. Pump-off system. Ken's Truck & Equipment: [www.khtrucks.com](http://www.khtrucks.com) 972-938-1905 or 214-632-5277 (CBM)

Pre-owned 2002 Sterling LT 9500 cab and chassis with a Clean Earth Safe Jet Vac 1015 Combo Unit. (Stock #3876C) [www.VacuumSalesInc.com](http://www.VacuumSalesInc.com), (888) VAC-UNIT (822-8648). (CBM)



Vac-Con V390LHA combination unit with Roots 827 blower, 1999 International Model 2554 cab and chassis. (Stock #3918C) **www.VacuumSalesInc.com, (888) VAC-UNIT (822-8648).** (CBM)

Vac-Con industrial machine mounted on a pre-owned 2004 Sterling cab and chassis. (Stock #8593C) **www.VacuumSalesInc.com (888) VAC-UNIT (822-8648)** (CBM)

2006 Volvo cab & chassis with a Vactor 2110 combination vacuum loader and high-pressure sewer cleaning system. (Stock #3483C) **www.VacuumSalesInc.com (888) VAC-UNIT (822-8648)** (CBM)

## LEASE/FINANCING

**North Star Commercial Credit:** Commercial loans for trucks or equipment. Flexible purchase programs to fit your budget. 21 years in the industry. Contact **Tom Myers - 877-804-2274.** (CBM)

"Lease to Own" financing of new or used sewer and drain equipment with early pay-off. Alpine Equipment Funding is a direct source of funding that understands your equipment needs. We are not brokers and will give you a quick response. Call 800-640-8660 (C04)

## LOCATORS

Used RIDGID NaviTrack, Gen-Eye Model 100 and Goldak Model 4400. The Cable Center 800-257-7209. (CBM)

## MISCELLANEOUS

Titan 8000 series, high performance, RIDGID 8000 Zero-Gravity. The Cable Center: 800-257-7209. (CBM)

## NOZZLES

**SAPPHIRE NOZZLES** for UHP, laser-etched, heat treated, excellent quality, fantastic savings! 772-286-1218. info@alljetting.com; www.alljetting.com. (CBM)

## PARTS & COMPONENTS



Units, nozzles, hoses, accessories and safety gear. From High Flow 65 GPM Units to High Pressure 6,000 PSI Units and everything in between. The best products and the best advice in the business.

**800-538-8464 | 770-740-9917**  
**www.usjetting.com** (CBM)

## PIPELINE REHABILITATION



**Steam Boiler Truck/unit:** 2005 Freightliner, 220K miles. Cleaver Brooks Model CBE200-125 diesel fire steam boiler. 2008 Ingersoll Rand compressor and Doosan generator. This unit is all plumbed and ready for work. \$94,000. Please email for additional info. C02  
**casbury@californiatrenchless.com**



**2013 Perma-Liner Turn-Key Trailer.** Used only 9 times 100 ft. of cal tube for ambient cure. Almost brand new. .... \$65,000  
**614-332-1277, OH**  
**drainbuster1@yahoo.com** C03

One trade-in model of Pipe Genie heavy-duty, pipe bursting equipment. Excellent condition, looks new, 30-ton, 100 feet cable, full 2-year warranty. 877-411-7473. (CBM)

CIPP equipment Perma-Liner: One (1) large inverter, One (1) medium inverter, inverter heads, some 6", 4", 3" liner, pull-tape resin, vac pump. Everything except air compressor. Very little usage. \$28,000. Contact John 973-667-7816 (C03)

## POSITIONS AVAILABLE

Need Superstar Salesman/Plumber. Might help the right candidate relocate to Southern California. Our top producer earns \$300,000+. If you are not in this class please don't call. Residential drain cleaning company. Rooter Hero 818-301-1465 (C03)

GapVax, Inc., a nationally recognized manufacturing business, is seeking a talented, highly motivated individual to fill a full-time Sales Position in the Midwest (Iowa based preferred) region. GapVax is the leading manufacturer of industrial and municipal vacuum units and hydroexcavation units in the United States. We provide the most reliable, comprehensive, and efficient mobile vacuum units in the industrial and municipal markets. Specifications of the position are listed on our website, www.gapvax.com, click on the Now Hiring link in the left hand column. Send resumes to Lthomas@gapvax.com or 575 Central Avenue, Johnstown, PA 15902. (CPMGBM)

Southwest Florida pipe inspection company looking for experienced laser profile, Vactor, CCTV, grout, and sag remover operators. Pay based on experience. Relocation benefit negotiable. EOE DFWP. Please send resume or contact info to sewerone@aol.com or call 239-267-3344. (C03)

## PUMPS

Honda model WP40X, 8 hp, 4" with hoses. Honda 4 hp, 2" pump with hoses. The Cable Center: 800-257-7209. (CBM)

## RENTAL EQUIPMENT

Liquid vacs, wet/dry industrial vacs, combination jetter/vacs, vacuum street sweeper & catch basin cleaner, truck & trailer mounted jettors. All available for daily, weekly, monthly, and yearly rentals. **VSI Rentals, LLC, (888)VAC-UNIT (822-8648) www.vsiRentalsllc.com.** (CBM)

LATERAL REINSTATEMENT CUTTER - RENTAL, 2" to 18" diameter. Reasonable rates, weekly/monthly. Training available. Contact: Sean Lipscomb, 443-866-8612, SLipscomb@PipelineRT.com (C02)

## SERVICE/REPAIR

**Dynamic Repairs - Inspection Camera Repairs:** 48 hour turn-around time. General Wire, Ratech, RIDGID, Electric Eel Mfg, Gator Cams, Insight Vision, Vision Intruders. Quality service on all brands. **Rental equipment available.** For more info call Jack at 973-478-0893. Lodi, New Jersey. (CBM)

## TOOLS

RIDGID model #300 with stand, RIDGID tri-stand vises, RP 330 ProPress kit. The Cable Center: 800-257-7209. (CBM)

# SOLD

Sell your equipment in *Cleaner* classifieds

Reach over 26,000 potential buyers each month when you list your equipment in the classified section. Plus, your listing is placed automatically online at the *Cleaner* website. In addition, your ad will be placed in the *Pumper e-Trader*, an electronic magazine that is e-mailed to readers. That's three ways to move your equipment out of the yard!

## Why wait?

Go to  
[Cleaner.com/classifieds/place\\_ad](http://Cleaner.com/classifieds/place_ad)



Scan the code with your smartphone.

PLACE YOUR AD ONLINE AT [www.cleaner.com](http://www.cleaner.com) - IT'S ALWAYS THERE TO MEET YOUR BUSY SCHEDULE



## TOOLS

**T&T Tools:** Probes, hooks. Probes feature steel shafts with threaded and hardened tips. The insulated **Mighty Probe™** tested to 50,000 volts. **Top Poppers™** open man-hole covers easily. Free catalog. [www.TandTtools.com](http://www.TandTtools.com). Phone **800-521-6893**. (CBM)

Bosch Brute hammer drill with cart irons. The Cable Center: 800-257-7209. (CBM)

Ritchie Yellow Jacket Recovery System & BULLET 7 cfm pump. The Cable Center: 800-257-7209. (CBM)

## TV INSPECTION

2001 GMC box van, 26,850 miles. PEARPOINT P420 6-wheel drive, pan and tilt camera head. Fully loaded van with sink, toolbox, a/c, arrow boards, strobe lights, and beacons. Explosion-proof camera, PipeLogix software, inclinometer, 1,000' of cable, 6" pipe and up. Generator hours 6,925. Email or call for pictures and any questions [mrbudmahler@gmail.com](mailto:mrbudmahler@gmail.com) 209-969-3496 or 209-629-6669. Ask for Bud. Asking \$50,000 OBO. (C02)



**1999 Ford E450 Hi-Cube CUES TV truck.** Reduced! \$35,000/negotiable. If interested, please call for more info and photos.

**904-284-2141, FL** C02

2003 Ford Aries TV Inspection: Stk# 2168, V10 Triton gas engine. Honda motor powers rear unit. One (1) camera. Ken's Truck & Equipment: [www.khtrucks.com](http://www.khtrucks.com) 972-938-1905 or 214-632-5277 (CBM)

**NEED TRACTION?** We make aftermarket more aggressive pads and chain assemblies for all chain-driven camera tractors. Custom, dependable, double-hole fabrication secured to high quality carbon steel chain, or just pads and rivets. Samples upon request. **Pipe Tool Specialties LLC:** 888-390-6794; Fax 888-390-6670; [www.yourtractionpads.com](http://www.yourtractionpads.com) or email [pts4422@yahoo.com](mailto:pts4422@yahoo.com) (CBM)

**PEARPOINT** — Mainliner buying & selling used equipment. Canada & USA **PEARPOINT MAINLINE EQUIPMENT ONLY.** Will buy complete Pearpoint trucks. Will buy your old system. Do you need parts? 399, 599 reels; 420, 448 tractors: 494 digital and zoom 420 light heads. Call 1-800-265-4298 or [mainliner2075@hotmail.com](mailto:mainliner2075@hotmail.com) (C02)

2000 Ford E350 CUES Prodata 2000 inspection van: 72,000 miles, roof air, 7kw Onan, TV & video monitor, camera, reel and cable & much more. Government retired. \$26,999. [www.shumatetruckcenter.com](http://www.shumatetruckcenter.com) 813-877-6638 (C02)

**CUES K2 SYSTEM:** Steerable Compact Pipe Ranger (CPR), OZ3 camera, 1000' gold cable, auto cable reel, CPU, CCU, wireless controllers, six different wheel sets, two different wheel spacer sets, tool and manual. Like new (app. 40 hours) at 20% off list. Call 866-936-8476 or [emailoffice@envirosight.com](mailto:emailoffice@envirosight.com). (CBM)

Used and rebuilt camera kits in stock: RIDGID Mini Compact, Mini Color, Standard Self-Leveling, General Gen-Eye I, II and III, Aries Seeker, and SRECO kits. The Cable Center: 800-257-7209. (CBM)

## VACUUM LOADERS

FOR SALE functional vacuum trucks: Guzzlers, Super Suckers, mid-1990s. Call for more information. 502-592-0543. (C03)

Wanted to purchase: Functional industrial vacuum trucks, wet or dry. Cash buyer. Call 502-592-0543. (C03)

## WANTED

Wanted to Buy: Vactor 2100's and late model Guzzlers. Cash. 800-336-4369. (CBM)

**Wanted:** Late-model sewer TV camera system complete with truck and latest software. [kemperconst@srt.com](mailto:kemperconst@srt.com) 701-838-1733 ND (C03)

**Buying Sewer Cleaners:** The fast, safe and easy way to sell your sewer cleaner, under any condition the best deal for you. 305-509-0467. [mmachinerymexico@gmail.com](mailto:mmachinerymexico@gmail.com) (C03)

## WATERBLASTING

Several trailer-mounted NLBs with Jetstream conversions. New paint, work ready. Several Guzzlers, Supersuckers and various other equipment priced to sell. 502-551-0158 (C02)

Gardner Denver T-375M: Bare Shaft pump. Gardner Denver T450M Bare Shaft pump. Gardner Denver TF-375M 21 gpm @ 10,000 psi. Gardner Denver TX-450HB 21gpm @ 20,000 PSI. Gardner Denver TF-450MB 52gpm @ 10,000 psi. NLB 10-200. 34 gpm @ 10,000 psi. HT-150S 25 gpm max 10,000 psi max, Shell Side Machine, Wheatley 165: 30 gpm @ 10,000 psi. Wheatley 125 with aluminum bronze fluid end. Boatman Ind. 713-641-6006. View @ [www.boatmanind.com](http://www.boatmanind.com). (CBM)

40,000 psi Sapphire Nozzles, UHP hoses & replacement parts. Excellent quality & prices. 772-286-1218, [info@alljetting.com](mailto:info@alljetting.com), [www.alljetting.com](http://www.alljetting.com). (CBM)

**WATER JETTING EQUIPMENT:** We sell, repair and retrofit water blasters. Visit us at: [www.waterjettingequipment.com](http://www.waterjettingequipment.com) or phone 714-259-7700. (CBM)

Wanted to purchase: Functional diesel waterblasters. Cash buyer. Call 502-592-0543. (C03)



**THIS IS WHAT IT WOULD LOOK LIKE IF WE PRINTED CLEANER.COM  
— THOUSANDS OF STORIES, PRODUCTS AND IDEAS.**

**Cleaner**

GET ACCESS TO EVERYTHING WE CAN'T FIT IN THE MAGAZINE. ADDITIONAL STORIES, VIDEOS, NEWS BRIEFS AND OTHER GREAT INFORMATION THAT LETS YOU GET THE MOST OUT OF *CLEANER*. [WWW.CLEANER.COM](http://WWW.CLEANER.COM)



**Cleaner  
AVERAGE  
MONTHLY  
CIRCULATION  
REACHES  
27,731  
READERS!**

PLACE YOUR AD ONLINE AT [www.cleaner.com](http://www.cleaner.com) — IT'S ALWAYS THERE TO MEET YOUR BUSY SCHEDULE



# Pumper Cleaner

# PROFIT

## Series

**3 DAYS OF HANDS-ON BUSINESS BUILDING & NETWORKING**

**ORLANDO, FLORIDA • GAYLORD PALMS**  
**MARCH 25-27, 2015**

**WWW.PUMPERPROFIT.COM**  
**866-933-2653**

### **DAY 1 & 2 - ELLEN ROHR**

- **WHERE DID THE MONEY GO?**
- **HOW MUCH SHOULD I CHARGE?**
- **REWARD THE RIGHT STUFF**
- **BUYING, SELLING AND GETTING OUT**

### **DAY 3 - JEFF BRUSS**

- **HOW TO USE AND UNDERSTAND SOCIAL MEDIA, E-MAIL AND THE INTERNET AS A BUSINESS TOOL**

### **SMALL BUSINESS BREAK-OUTS**

- **MARKETING**
- **EMPLOYEE RETENTION AND HIRING**
- **SALES AND PRICING STRATEGIES**
- **BUYING OR SELLING A BUSINESS**
- **PROFITABLE IDEAS**

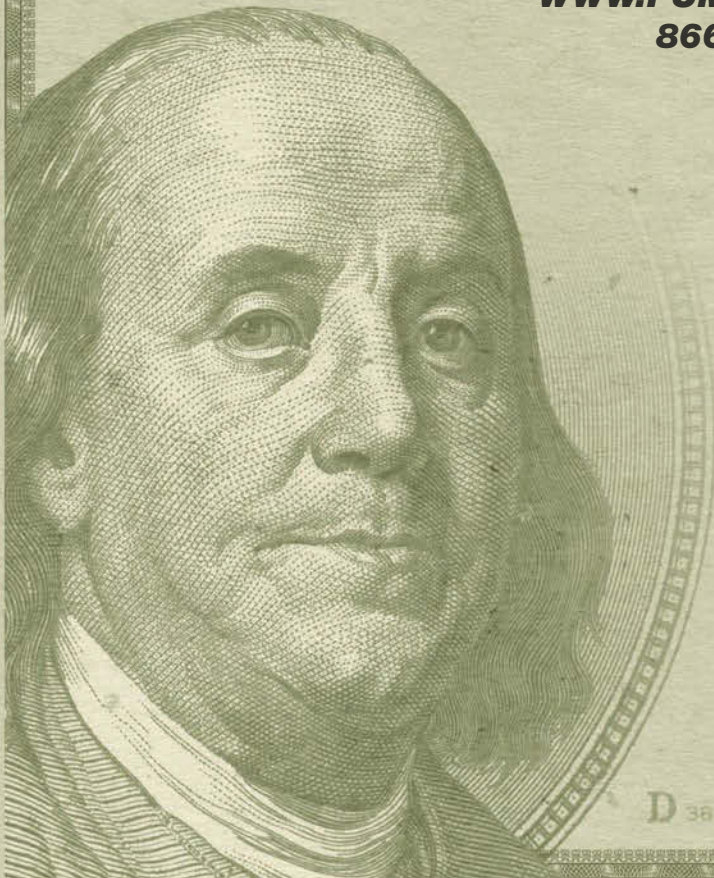



# THE CABLE CENTER • 1-800-257-7209



**24 HOUR TURNAROUND - MIDWEST'S LARGEST FACTORY AUTHORIZED  
REPAIR CENTER FOR GEN-EYE, GATORCAM & SEESNAKE**



## ClogChopper™

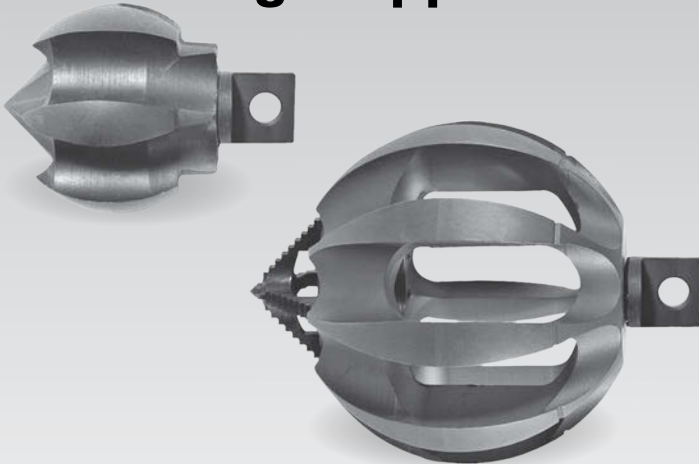

- Multi-function cutting tools
- Six self-sharpening blades
- Risk-free pipe damage
- Maneuvers around tight bends
- Safe cleaning on metal, plastic and clay pipes
- Variety of sizes
- Connector options for most drain cleaning machines

**CALL FOR PRICING!**

## NEW Gen-Eye Hot Spot™ Pipe Locator



- Easy to read display – Icons lead you to your target and auto backlight lets you locate in dimly lit areas.
- Total field antenna array – Allows you locate from any direction.
- Line direction compass – Tells you the lay of the pipe.
- Industry's most rugged locator – Rated IP65, the industry's highest, it is dust and dirt proof and water resistant.
- Superior Battery Life – Batteries lasts twice as long as other brands.
- Expanded Frequencies – Locates two sonde frequencies, two power frequencies and four line frequencies.
- Upgradeable Software – Use the USB port to upgrade software in the field.

**CALL FOR PRICING!**



**General J-2900**  
Basic Unit Machine Only

**\$2745**  
FREE DELIVERY



**General J-1450**  
Portable Jetter  
Basic Unit Machine Only

**\$1540**  
FREE DELIVERY



**Mini-Rooter XP™**  
Basic Unit – No cable cutters  
or power feed

**\$580**  
FREE DELIVERY



**General Speedroooter 92™**  
Basic Unit – No cable cutters  
or power feed

**\$1160**  
FREE DELIVERY





See you in Indy!  
Booth 6004

**wwett**  
Water & Wastewater Equipment,  
Treatment & Transport Show

# GapVax®



www.gapvax.com

# #1 CHOICE

industrial vacuum equipment manufacturer



Custom Built - industrial vacuum loaders,  
hydro excavators, jetvacs, skid-vacs, and more!

Want easy to use, reliable and durable  
vacuum equipment that outperforms the others?  
Then give us a call!

Texas office 281-884-8658



888-442-7829



# A SIGHT TO BEHOLD.

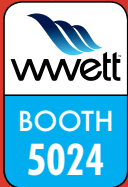

Now  
Available for  
Android



**SPARTAN**  
FOR TOUGH CUSTOMERS.  
SINCE 1943

The future is at your fingertips with Sparvision 200, a state-of-the-art pipe-inspection camera designed with you in mind. Featuring a wireless retina-display iPad® 4 as its screen, the Sparvision 200 offers full tablet computer features like instant snapshots, on-screen drawing and a touch keyboard for captions. With the Wi-Fi-enabled iPad, simply send the photo or video you shot directly to the customer and store your copy right on the tablet. The Sparvision 200 offers a self-leveling color camera, a 512 Hz locating beacon and a 200' high-efficiency, super-slick push rod. Plus, the entire unit is powered in the field with an on-board battery so you can take it anywhere. **If you're looking for the best, look no further.**