

FOR RESIDENTIAL, MUNICIPAL AND INDUSTRIAL CLEANING CONTRACTORS

# Cleaner®

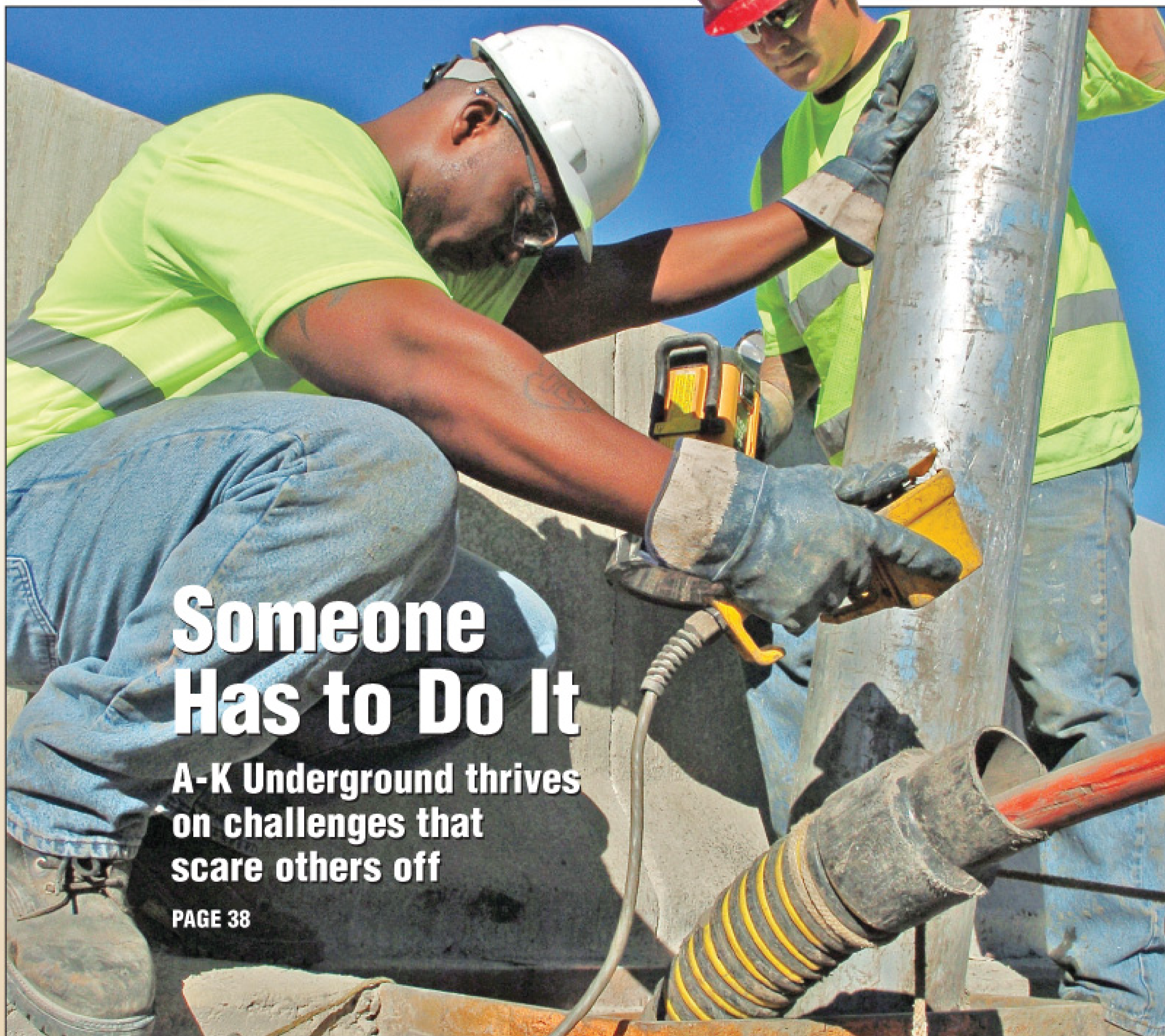

## Someone Has to Do It

A-K Underground thrives  
on challenges that  
scare others off

PAGE 38

### READER PIPELINES

Training employees  
for confined spaces

### AFTER HOURS

A cleaning contractor  
supports his son's  
racing dream

### MONEY MACHINES

Jetting truck from  
Kline's Services,  
Salunga, Pa.

# Maxi-Rooter™

## COMES THROUGH FOR YOU

- Slim 23" profile lets you get the machine through just about any door.
- Big capacity drum holds 125 ft. of 3/4" cable or 150 ft. of 5/8" cable.
- See-through inner drum cage lets you see how much cable is left in the drum.
- Tough aluminum alloy frame takes all the abuse you can give it and comes back for more.
- A heavy-duty quiet 3/4 hp motor drives either Flexicore® wire rope center cable or loose-wound "SP" type cable. Your choice!
- Rolls on 10" semi-pneumatic wheels, has V-belt stair climbers, and a truck loading wheel to help you lift the machine into your truck.

The Maxi-Rooter packs maximum power and reach with maximum reliability. For quick information, call the Drain Brains® at General at 800-245-6200 or 412-771-6300, or visit [www.drainbrain.com/max](http://www.drainbrain.com/max).



**General**  
**PIPE CLEANERS**

[www.drainbrain.com](http://www.drainbrain.com)

MADE IN USA

**The toughest tools down the line.™**

© General Wire Spring 2007



**Making Our Competition See Red For 20 Years.**

**VAC-CON MACHINES SET PERFORMANCE STANDARDS AT THE HIGHEST LEVEL.**

No matter the job, you can count on a Vac-Con to make top performance and safety features standard. No up charges for options that aren't really optional. And our complete line covers every application with a machine designed to get the job done faster and safer, increase up time, and last longer:

- Combination Sewer Cleaners
- Industrial Vacuum Machines
- Hydro-Excavating Machines

At Vac-Con, top performance isn't an option.



**VAC-CON**  
**MORE POWER TO YOU**



1-800-252-0043



### MudDog Hydroexcavator

2008 Sterling 9500, CAT C13, manual, full opening tailgate, vacuum pump 3600 CFM, Triplex water pump 10 GPM and 2000psi, 335° boom rotation.

[www.nescosales.com](http://www.nescosales.com)

NESCO LLC • 3112 E STATE RD 124 BLUFFTON

IN 46714

Where highest quality meets lowest cost



- Four alarm levels
- Simple automatic calibration procedure
- Fully compatible with BW's MicroDock II automatic test and calibration system
- Delivered ready for use

**\$499.00**  
Limited Time Only!

While Supplies Last.

# MRP

Milwaukee Rubber Products, Inc.  
P.O. Box 451 • Butler, WI 53007  
N52 W13319 Falls Creek Ct.  
Menomonee Falls, WI 53051

**Toll-Free**  
**1.800.325.3730**

[www.milwaukeeerubber.com](http://www.milwaukeeerubber.com)

- Rugged, ultra-compact and lightweight
- Simple one-button operation
- Durable, stainless steel alligator clip
- Continuous LCD shows simultaneous gas concentrations for H2S, CO, O2, and combustibles
- Powered by a lithium polymer battery
- Equipped with internal vibrating alarm for high noise areas
- Backlight

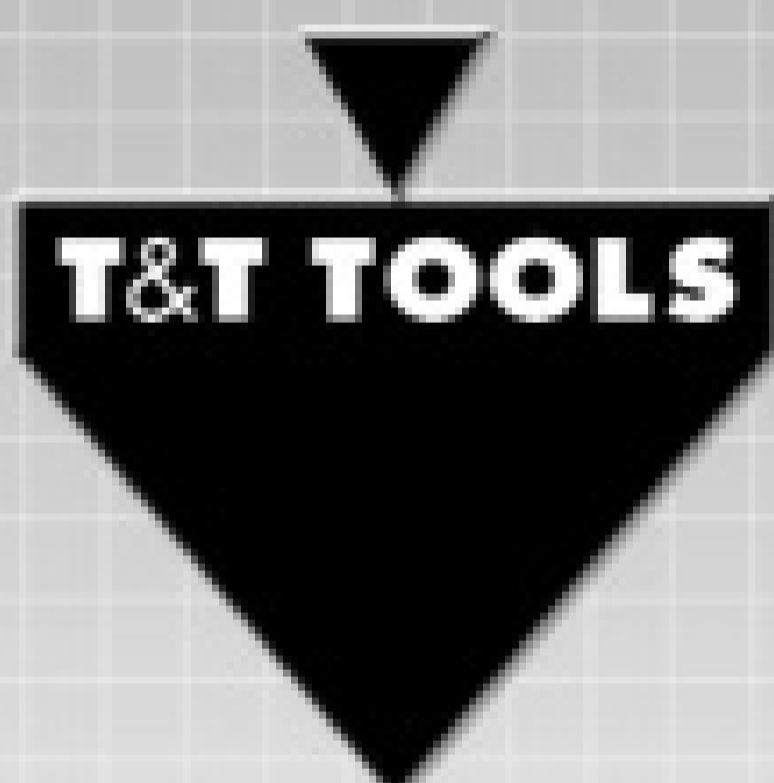

## T&T Tools, Inc.

Fax: 800.521.3260  
Email: [sales@tandttools.com](mailto:sales@tandttools.com)

**800.521.6893**  
**[www.MightyProbe.com](http://www.MightyProbe.com)**

Call for a FREE Catalog

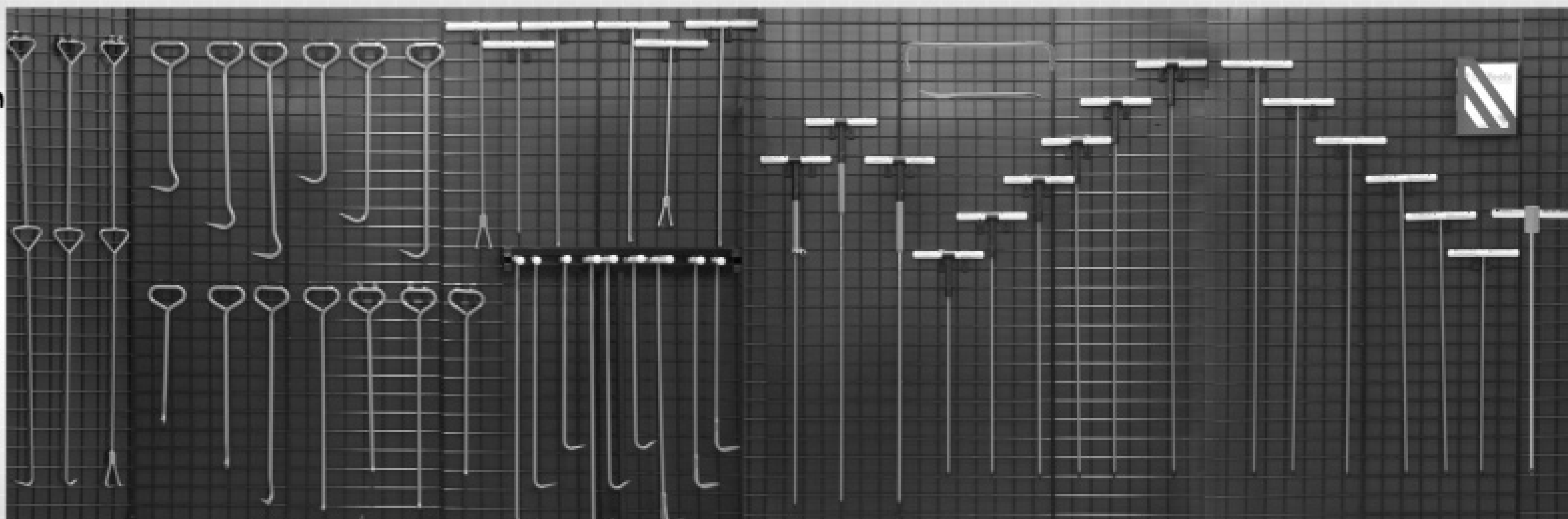

Call for a FREE Catalog

### HOOKS...

- > Several different styles of heat-treated hooks are available
- > Top Poppers are great to open manhole covers
- > The Handy Hooks allow two handed use

### PROBES...

- > Insulated, standard, and specialty soil probes
- > Metal shaft sizes: 3/8" round, 3/8" hex, or 7/16" hex
- > Replaceable tips are threaded on and hardened
- > A "slide" allows the handle to pound the shaft into the ground

# See for Yourself.

## Underground Infrastructure Inspection That Is Quick, Affordable & Safe.

Inspect pipelines, manholes and tanks from street level with the patented QuickView zoom inspection camera. Municipalities use it to identify and prioritize maintenance issues. DOTs use it to assess culvert and storm pipe condition with minimal exposure to traffic. Contractors use it to survey pipe condition before bidding, and to document completed work. With 216:1 zoom and HID lamps, QuickView sees 50–250' in 6–60" lines.



**45-60 FT**

*Onscreen Distance Measurement*

*“My crews verify pipe condition without confined space entry. With QuickView, they accomplish more footage in a safer manner, without full-blown crawler inspection.”*

**—Steve Kynerd, Sr. Transportation Supervisor, Hillsborough County, FL**

- Easiest to use (joystick controls, onscreen menus, lightweight carbon fiber pole and operator vest).
- Greatest range (up to 250').
- Only stabilizer with integral view centering.
- Only system that measures target distance, pipe diameter, and manhole depth/diameter (see right).



- ▶ \$1000 EnviroSight Credit with Purchase†
- ▶ Largest Network of Svc./Training Centers Across North America

**Root Intrusion**

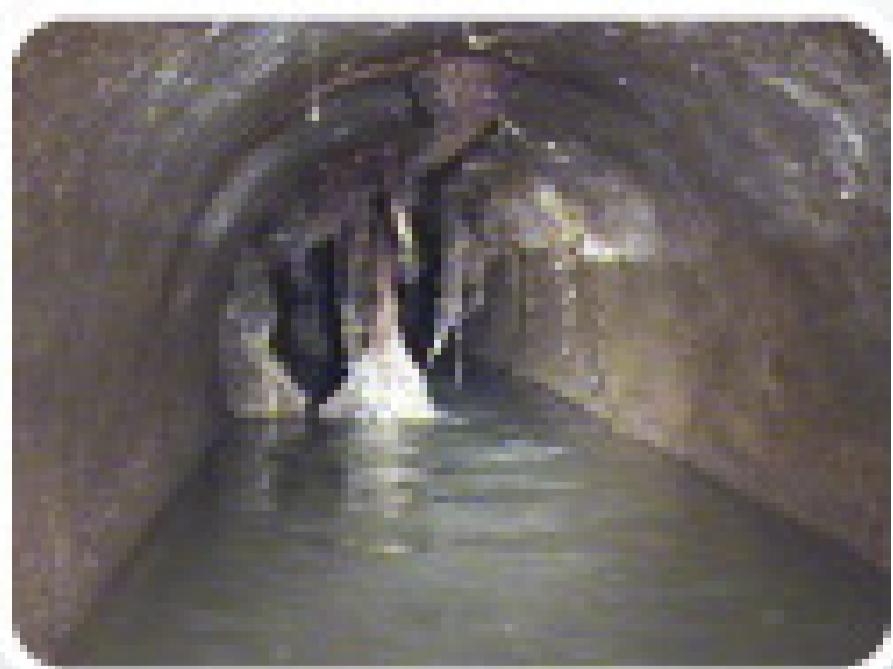

**Severe Offsets**



**Gushing Infiltration**



**Fence Post Breach**



**Buildup**



The QuickView and EnviroSight names and logos are trademarks of EnviroSight, LLC. ©2006 EnviroSight, LLC. All rights reserved. QuickView carries patent no. 6,538,732 and 7,009,899. Other patents pending. †Credit may not be applied to future QuickView purchases.

**www.envirosight.com • (866) 936-8476 • fax (973) 252-1176**  
 Headquarters: Randolph, New Jersey • Sales & Service Offices Worldwide





## ARTICLES

### 38 SOMEONE HAS TO DO IT

By Mary Shafer

**On the cover:** A-K Underground of Tinley Park, Ill., has found a niche in difficult and often distasteful jobs that other contractors don't want. Clients depend on the firm to show up on time with trained people equipped to get the work done fast. Here, technicians Larry Jeffries (left) and Chuck Cushing vacuum debris despite difficulty with a sewer frame offset from the structure opening. (Photo by Dave Kenik)

### 12 KEITH HUBER WAS VACUUM TRUCK PIONEER

By Jim Kneiszel

### 30 BETTER BUSINESS: MORE THAN A BOOKKEEPER

A quality accountant can provide analytical services and sound advice on a variety of issues and decisions that drive success and growth.

By Mark E. Battersby

### 48 SEALING THE CHIMNEY

A wide variety of grouts and sealants help municipal departments protect against clear water infiltration in manhole structures.

By Scottie Dayton

### 58 BACK ON TOP

An Ohio contractor weathers personal tragedy, an economic slowdown and a limited customer base by diversifying offerings and courting a wider range of clients.

By Peter Kenter

## REGULAR FEATURES

### 10 FROM THE EDITOR: WHAT'S YOUR PASSION?

A new 'After Hours' column in *Cleaner* looks at how contractors mix work with family matters, hobbies, and creative pursuits.

By Ted J. Rulseh

### 16 SAFETY FIRST: IN THE ZONE

Roadway work zone safety means staying focused and avoiding distractions.

By Scottie Dayton

### 24 MONEY MANAGER: 10 WAYS TO HURT YOUR BUSINESS

If you want to make life in business tougher than it needs to be, here are ten good prescriptions to try on a regular basis.

By Erik Gunn

### 78 MONEY MACHINES: NO MORE PING-PONG

A fleet of specially designed drain-cleaning trucks helps a Pennsylvania contractor keep its technicians productive and serve customers well.

By Ken Wysocky

### COMING IN AUGUST

#### Waterjet cleaning and Accessories

- Reader Pipelines: Protect your workers against biological hazards
- Profile: Chuck's Septic Tank, Sewer & Drain Cleaning Inc., Columbus, Ohio
- Profile: L.W. Morgridge & Son Inc., Eliot, Maine
- Safety First: Keeping the fleet and drivers safe
- Better Business: Finding prosperity in an economic downturn

### 68 NEW AFTER HOURS: FEAR GETS LAPPED

An industry contractor relocates his business and family to help his son pursue a promising career as a stock car driver.

By Ted J. Rulseh

### 74 OVERHEARD ONLINE: THE IDEAL VEHICLE

Contracting professionals share thoughts on service trucks that deliver convenience, efficiency, comfort, and affordable cost.

### 86 TECH PERSPECTIVE: INJECTING LONG LIFE

Chemical grouting provides simple and cost-effective repair for manhole leaks — if you use the right material and the right installation method.

By Scott Kelly

### 92 READER PIPELINES: LIFE AND DEATH

Contractors and municipal agencies emphasize safety for confined-space entry, trenching, and other potentially dangerous duties their people may face.

By Mary Shafer

### 96 TOUGH JOB: CLEAN SWEEP

A sewer pipe floor-cleaning nozzle enables a New York village to keep its street reconstruction program on schedule.

By Scottie Dayton

### 106 INDUSTRY NEWS

### 108 PRODUCT NEWS

Product Spotlight: A truck body designed for technician productivity.

By Ken Wysocky

## Cleaner

FOR RESIDENTIAL, MUNICIPAL AND INDUSTRIAL CLEANING CONTRACTORS

[www.cleaner.com](http://www.cleaner.com)

Published monthly by  
**COLE Publishing Inc.**  
1720 Maple Lake Dam Rd.  
PO Box 220  
Three Lakes WI 54562

© Copyright 2008 COLE Publishing Inc.  
No part may be reproduced without permission of the publisher.

U.S. or Canada call toll-free 800-257-7222  
Elsewhere call 715-546-3346  
E-mail: [info@cleaner.com](mailto:info@cleaner.com)  
Web: [www.cleaner.com](http://www.cleaner.com)  
Fax: 715-546-3786

Office hours 7:30 a.m. - 5 p.m.  
Central Time, Monday-Friday

**SUBSCRIPTION INFORMATION:** A one year (12 issue) subscription to *Cleaner* in the contiguous 48 U.S. states costs \$15.50 (24 issues for \$25; 36 issues for \$35). Subscriptions to Canada or Mexico cost \$27.50 per year (24 issues for \$52). Subscriptions to all other foreign countries cost \$80 per year. Subscribers are guaranteed monthly delivery of the paper. To subscribe, send company name, mailing address, phone number and check or money order (U.S. funds payable to COLE Publishing Inc.) to the address above. MasterCard, VISA and Discover are also accepted. Supply credit card information with your subscription order.

**CLASSIFIED ADVERTISING: RATE:** \$1 per word, per month. Minimum of 20 words or \$20. All classified advertising must be PAID IN ADVANCE. **DEADLINE:** Classifieds must be received by the first of the month for insertion in the next month's edition. **PHONE-IN ADS ARE NOT ACCEPTED.** Ads may be faxed only when charging to MasterCard, VISA or Discover. Please supply all credit card information with faxed ads. Be sure to include your phone number (with area code) in your ad. Make checks payable to COLE Publishing Inc. and mail with classified ad to the address above. **CLASSIFIED ADVERTISING APPEARS NATIONWIDE AND ON THE INTERNET.** Not responsible for errors beyond first insertion.

**DISPLAY ADVERTISING:** Call 800-994-7990 and ask for Jeff, Jim, Kim or Winnie. Publisher reserves the right to reject advertising which in its opinion is misleading, unfair or incompatible with the character of the publication.

**CIRCULATION:** Circulation averages 27,150 copies per month. This figure includes both U.S. and international distribution.



### PUMPER & CLEANER ENVIRONMENTAL EXPO INTERNATIONAL

Education Day: Feb. 25, 2009  
Exhibits Open: Feb. 26-28, 2009

Kentucky Exposition Center  
Louisville, Kentucky  
[www.pumpershow.com](http://www.pumpershow.com)

# New!

# MORE AMMUNITION FROM THE MAKERS OF ROOTX



## Arm your crews with Grease-X to keep your pipelines FOG-free

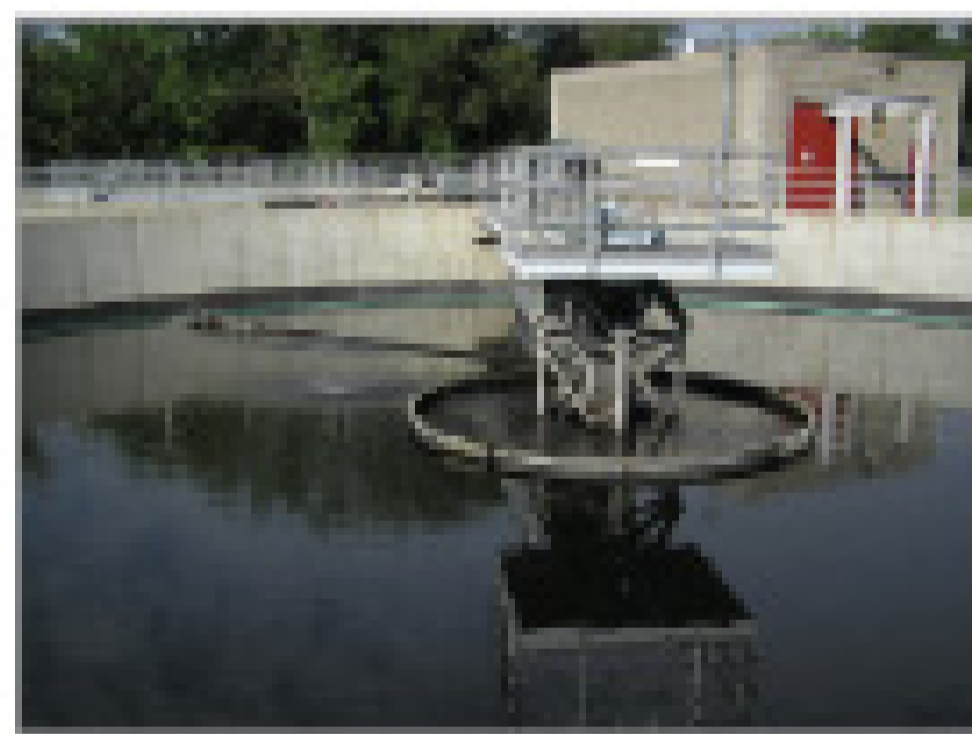

Grease-X reduces the load on your wastewater treatment plants.

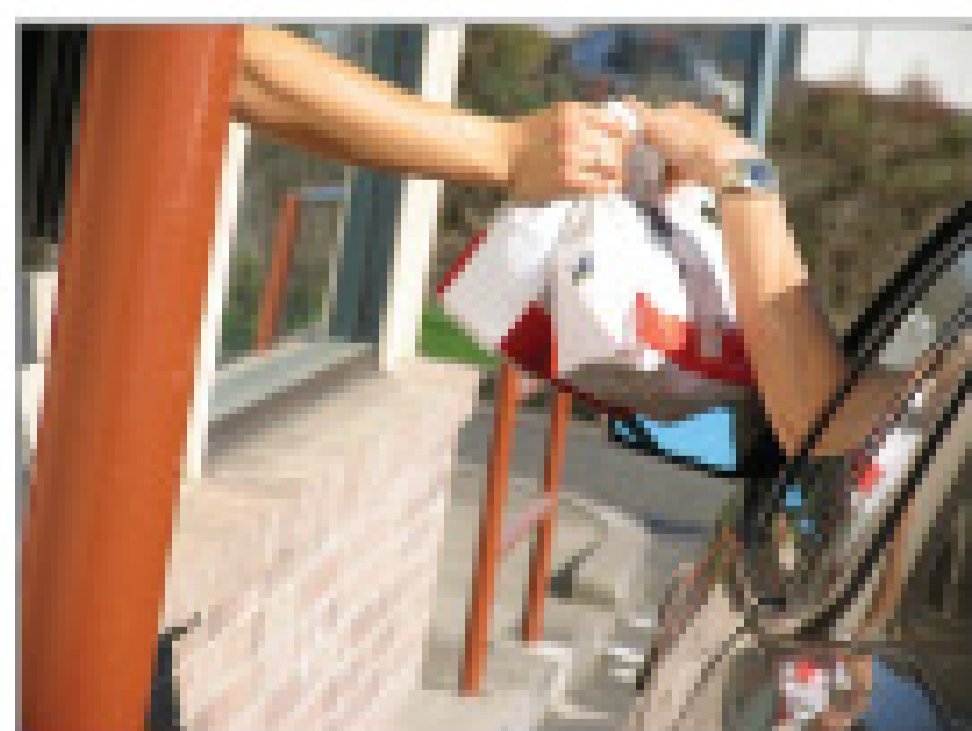

Regular treatments with Grease-X can help prevent FOG buildups—important in problem areas such as near fast-food restaurants.

Introducing Grease-X®—four powerful weapons in the battle against the fats, oils and grease (FOG) that can clog municipal wastewater systems. Grease-X gives you the power to clear FOG-choked pipelines and lift stations, prevent FOG buildup and eliminate pipeline odors using your own crews and equipment.

- **Grease-X Emulsifier**—Non-caustic, non-polluting formula penetrates and softens FOG to clear blocked lift lines.
- **Grease-X Jet**—Fast-acting emulsifier specially formulated for your jetting equipment to open blocked pipelines.
- **Grease-X Biozyme**—Highly concentrated microorganisms break down and digest FOG to keep pipelines clear.
- **Grease-X Biodeodorizer**—Digests odor-causing wastes to eliminate pipeline odors at the source.

## Complete sewer system maintenance from a name you trust

You can count on Grease-X to be easy to use and effective because it comes from the makers of RootX®. Together, RootX and Grease-X



give you all the ammo you need to keep your wastewater system flowing smoothly.



Both RootX and Grease-X are non-caustic and non-polluting—so they won't harm pipes or wastewater treatment operations. And both are easy to apply. Your crews can treat a 400-foot mainline with RootX in 30 minutes or less. FOG-choked pipelines can be cleared by simply adding Grease-X Jet to normal jetting operations. Plus, Grease-X Biozyme comes in convenient, water-soluble bags, making it easy to keep your pipelines FOG-free.

It takes just 30 minutes to treat a 400-ft. mainline with RootX.

Don't wait for FOG or roots to back up your sewer system. Arm your crews with RootX and Grease-X.

RootX kills roots on contact and keeps them from coming back.

Call 800-844-4974 or visit [www.rootx.com](http://www.rootx.com) to learn more.

**A**

Advanced Hydro-Dynamics ..... 46



Advanced Infrastructure ..... 22

All Star Sewer Equipment ..... 93

Allan J. Coleman Co. .... 21, 83

Almetek Industries, Inc. .... 45

Amerik Engineering ..... 44



Aqua Mole Technologies ..... 45



Aries Industries, Inc. .... 56-57

Arthur Products ..... 54

**B**

Blasters, Inc. .... 18



Bowman Tool Co. & Systems .... 62

**C**

Cable Center, The ..... 28, 51

Cam Spray ..... 44



Central Oklahoma Winnelson .... 52

Chempure Products Corp. .... 66

Cherne Industries, Inc. .... 14

CIPP Services ..... 46

Cloverleaf Tool Co. .... 41, 79



Cobra Technologies ..... 18

Coxreels ..... 45

CT 2000 ..... 88



CUES, Inc. .... 31

**D**

De Neef Construction ..... 54

Doug Meadows Co. LLC ..... 41



Drainables Direct ..... 44



Duracable Manufacturing Co. .... 76

Dyna-Vac Equipment ..... 34

**E**

Easy Cam, LLC ..... 97



Electric Eel Mfg. .... 111

Engines, Inc. .... 80

Environmental Products ..... 26

**Envirosight**

Envirosight, LLC ..... 5, 15



ENZ USA, Inc. .... 76

**F**

Fluid Systems, Inc. .... 106

Fruitland Tool & Manufacturing ... 84



FS Solutions ..... 90, 91

**G**

G & R Cable Co. Inc. .... 90

GapVax Incorporated ..... 110

Gardner Denver Waterjetting ..... 50

Gardner Denver, Inc. .... 22



General Pipe Cleaners ..... 2

Global Pipeline Systems ..... 42

Gorlitz Sewer & Drain, Inc. .... 19

Granite Leasing Co. .... 85



Guzzler Mfg. Inc. .... 11

**H**

Haaker Equipment Co. .... 50

Hackney Specialized Vehicles .. 12, 92

Hammerhead, an Earth Tool Co. 27

Hannay Reels ..... 80

Harben, Inc. .... 71

Hi-Vac Corporation ..... 65

Hurco Technologies, Inc. .... 73

**I**

Insight Vision ..... 32

**J**

Jack Doheny Supplies, Inc. .... 43



Jetstream of Houston ..... 17

**K**



KEG Technologies Inc. .... 106

Ken-Way Corp. .... 64

KMH Equipment, Inc. .... 82

KMT Aqua-Dyne, Inc. .... 93

Kroy Industries ..... 62

**L**

LaPlace Equipment Company .... 62

Lansas Products Mfg. .... 53

Lenzyme Inc./Trap-Clear ..... 47

Liberty Financial Group Inc. .... 80

Lindhorst Workhorse Nozzles ... 70

Link Manufacturing ..... 79

**M**

MaxLiner ..... 95

Milwaukee Rubber Products ..... 4



Mongoose Jetters ..... 75

Mr. Manhole ..... 14

Mr. Rooter Corp. .... 63

Municipal Equipment ..... 29



MyTana Mfg. Company, Inc. .... 61

**N**

NESCO Inc. .... 4

NLB Corp. .... 33



Northcutt Co./Scooter Video ..... 77



NozzTeq, Inc. .... 72

**P**



Pat's Pump & Blower ..... 36



Pearpoint/Radiodetection ..... 54



Perma-Liner Industries, Inc. .... 13

Petersen Products Co. .... 88



Pipe Genie Manufacturing ..... 88

PipeLogix, Inc. .... 64

Piranha Hose Products ..... 87

Poly-Flow Mfg. LLC ..... 12

Precision Tank & Equipment .... 28



PrimeLine Products, Inc. .... 34



Prototek Corp. .... 64



Pulsar 2000 ..... 20

Putzmeister America Water ..... 42

**R**

RABCO ..... 10



Ratech Electronics Ltd. 41, 43, 45, 47

Rausch Electronics USA, LLC .. 72

Relining Technologies, LLC ..... 9

RIDGID ..... 35

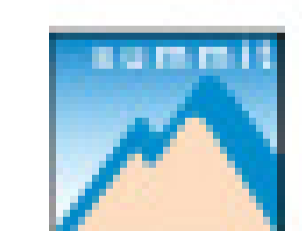

Ritam Technologies, LP ..... 82



RootX Root Control Corp. .... 7

**RS Technical Services Inc.**

RS Technical Services ..... 66

**S**

Safety Corporation of America ... 52

Sewer Equip. Co. of Florida, Inc. 94

Sewer Equipment & Supplies ... 14

Sewerin USA LLC ..... 90



Shamrock Pipe Tools, Inc. .... 46



Spartan Tool, LLC ..... 112

Speedway Drain Cleaning Prod. .. 70

SPIR STAR, Ltd. .... 43

SRECO-FLEXIBLE, Inc. .... 81

Stephen's Technologies ..... 55

StoneAge, Inc. .... 36, 84

Super Products LLC ..... 32

**T**



T&T Tools, Inc. .... 4

TRIC Tools Inc. .... 74

Triple R Specialty ..... 16

TRY TEK Machine Works, Inc. ... 16

**U**



UEMSI ..... 20

US Jetting, LLC ..... 25



USB Sewer Equipment Corporation 95

**V**

Vac-Con, Inc. .... 3



Vactor Manufacturing ..... 82

Vacuum Sales Inc. .... 22

Vaporoooter ..... 67



Vision Technology Design & Mfg. 94

Vivax Corp. .... 26

**W**

Water Cannon Inc. .... 89

Western Sales LLC ..... 24

Westmoor Ltd. .... 47



WinCan America, Inc. .... 23

Wolf Creek Co., Inc. .... 18

WOMA Corp. .... 52

**Classifieds** ..... 98-101

**Marketplace** ..... 102-104

**Truck Stop** ..... 105

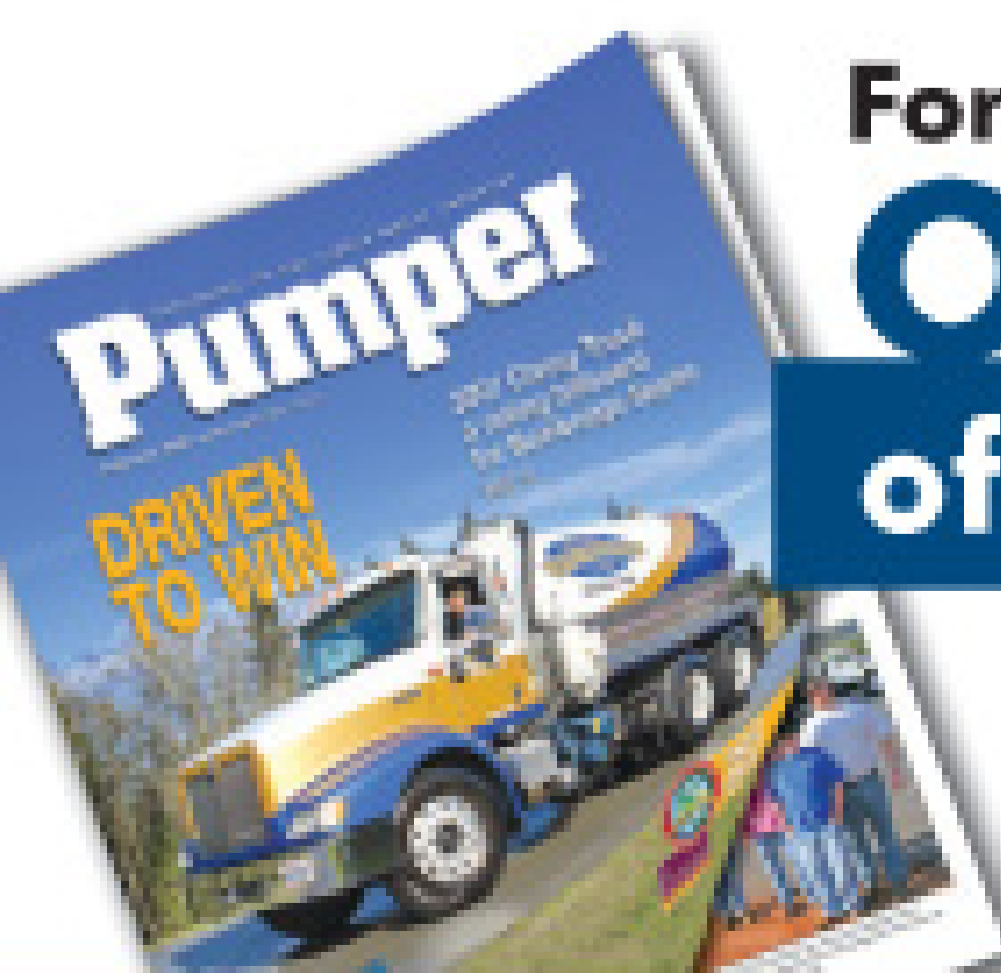

For the  
**OTHER SIDE**  
of Your Business

Does your business include services like septic tank maintenance, grease trap pumping, and portable restroom rental?

If so, then consider a subscription to **Pumper**® — the publication exclusively for the septic and portable sanitation industries. For nearly three decades, *Pumper* has been the definitive guide to the latest products, technologies and methods for these industries. Like *Cleaner*, it brings information you can use to make your business bigger, better and more profitable.

**SUBSCRIBE TODAY. [www.pumper.com](http://www.pumper.com) or 800-257-7222**



# PLUMBING CONTRACTORS



## INCREASE YOUR BOTTOM LINE.

With An **Easy Liner** System, Offering CIPP Lining Services to Your Customers Has Never Been Easier or More Profitable!

Relining Technologies, the national distributor of Easy Liner CIPP products and equipment provides contractors complete turn-key solutions to get involved in the fastest growing and greatest profit generating segment of the plumbing market.

- Rehab 2" to 12" diameter lines
- Applied from the clean out
- Minimal disruption
- Cures in just over 1 hour
- Installed within 1-2 hours
- Custom-built lining rig to fit your needs and budget
- Retrofits of your existing equipment available
- Financing available

*Since adding 2 Relining Technologies trucks to our fleet, we've increased our revenue over \$600,000 per month.*

-- Jeff Stanley, President  
Rapid Plumbing Inc., California

Let Relining Technologies show you how to achieve similar results. Call today.



 **Relining  
Technologies**

CONTACT: 800 496 1498

[www.reliningtechnologies.com](http://www.reliningtechnologies.com)

*NO franchise or territory fees!!!*

## What's Your Passion?

A new 'After Hours' column in *Cleaner* looks at how contractors mix work with family matters, hobbies, and creative pursuits

Ted J. Rulseh



A neighbor down the street is an attorney, a sports lover, and all-around good guy. He's also, I learned quite some time after meeting him, a wine collector.

He has a cellar in his basement that contains some 3,000 bottles, much of it from European countries, and a considerable amount from vineyards in California whose owners he has come to know personally.

If you guess that my first visit to his cellar included a fairly long dissertation on wines, you'd be right. And my wife and I enjoyed it greatly.

The point is that we often don't find out how interesting people are until we see what they do on evenings and weekends. Most of us aren't fortunate enough to have careers we enjoy so much that they feel like recreation. So we own a business or hold a job that we find satisfying and that pays the bills, and we pursue passions when we can.

A new occasional column in *Cleaner*, titled "After Hours," looks at how service business owners invest their spare time. Judging from contacts we've made and stories we've planned so far, cleaners are interesting folks indeed.

### Lots of variety

The first "After Hours" story, in this issue, features David Currier, who moved his family and his business from Massachusetts to North Carolina so his son, David Jr., could pursue a promising career

in stock car racing.

It's not just about the racing, of course. It's about how Currier's wife, Cindy, and the kids adapted to new surroundings. And how David Sr. went about buying and building a new business in unfamiliar surroundings.

We're planning other stories on contractors whose pursuits include starting a Bible college, performing in a country band, building custom motorcycles, and putting on a huge Halloween haunted manor. We hope to include features on the spouses and families of contractors, their special interests, and how they deal with the

from topics like fuel prices, hiring practices and camera technologies to hobbies, children, pets, car restoration, fishing, sun-downer farming, travel. That's where friendships get formed.

So think of "After Hours" as a place to learn about new sides of industry colleagues you may or may not know, and how they find a place within business life for their favorite pursuits. You might even get inspired to make your own passions more of a priority in your life — and so be a little richer.

We'd like to run this feature often, and to do it we'll need to know about cleaners and families

**It's easy for a trade magazine to take itself a bit too seriously, to focus on business matters to the exclusion of all else. It's fitting for a magazine like this one, which serves mostly small family-owned businesses, to pay attention to the personal and family side of things, and in fact to celebrate them.**

special rewards and complications that go with a family business.

We all know there's more to life than work. A wise man once observed, "No one on their death bed has ever said, 'I wish I had spent more time at the office.'"

It's easy for a trade magazine to take itself a bit too seriously, to focus on business matters to the exclusion of all else. It's fitting for a magazine like

this one, which serves mostly small family-owned businesses, to pay attention to the personal and family sides of things, and in fact to celebrate them. And so we will.

### Finding inspiration

It's easy to imagine conversations between cleaners at industry venues like the Pumper & Cleaner Expo turning eventually away

who have interesting sidelines and interesting ways of keeping family life vibrant, even though the work days and weeks get hard and long.

So we invite you to let us tell your story. Or to let us know of someone in the business you like and admire who pursues a passion others would enjoy knowing about.

Just follow "After Hours" — without expecting it to appear every month, at least in the beginning. And if the spirit moves you to offer a story, please do. Just drop me a note to [editor@cleaner.com](mailto:editor@cleaner.com) and I'll be sure to respond. ■



### Universal Roller Skid for Pipeline Diagnostics

Works with most industry Standard Push cameras!

Patented spring-loaded design dynamically adjusts to required size!

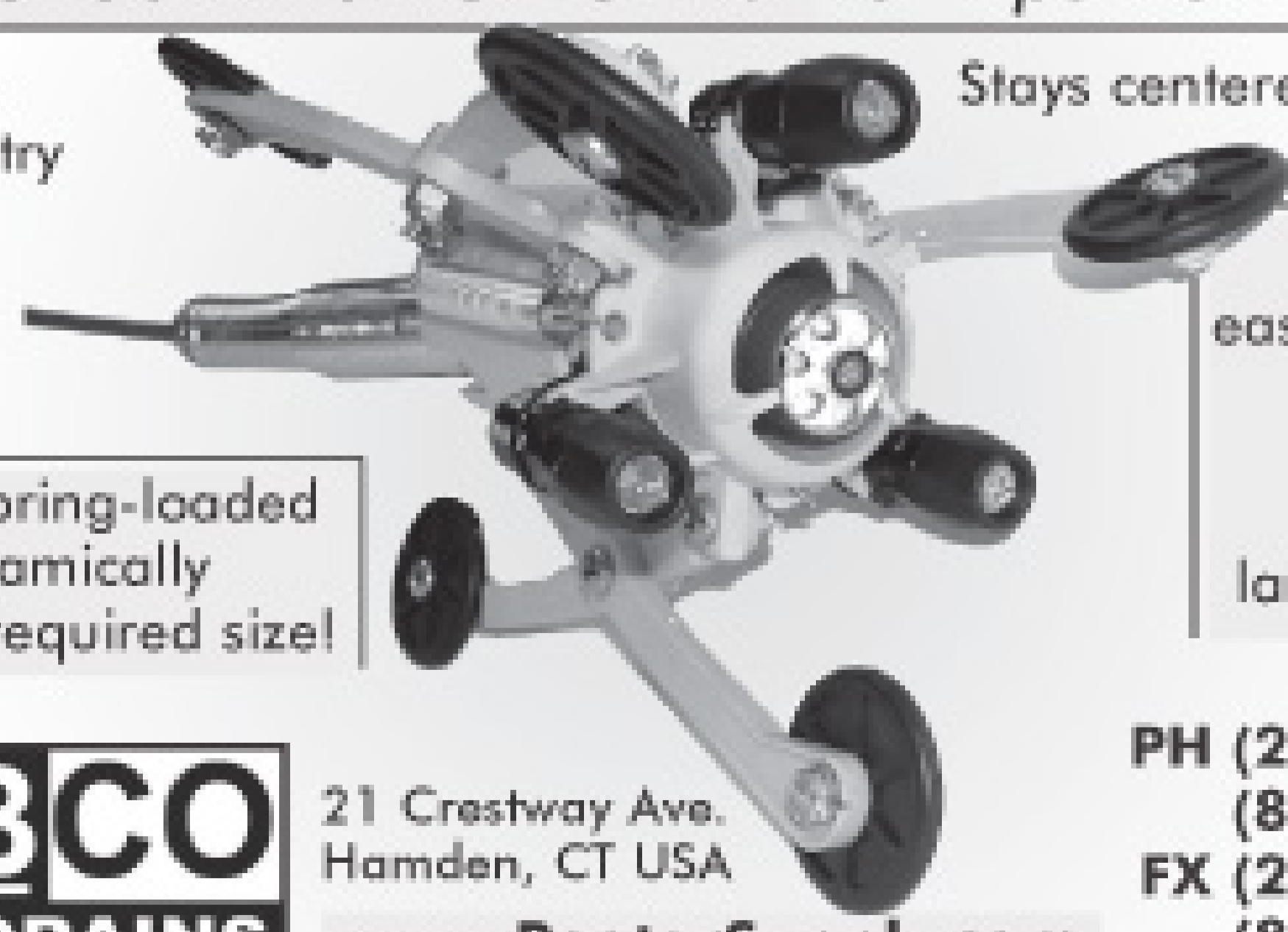

Stays centered at all times!

Quickly and easily adapt your push camera for use in 6" to 12" and larger pipelines!

**RABCO**  
800-2-DRAINS

21 Crestway Ave.  
Hamden, CT USA

[www.Rootersupply.com](http://www.Rootersupply.com)

PH (203) 230-1693  
(800) 237-2467  
FX (203) 230-2956  
(800) 535-3332



# WE DELIVER MORE THAN JUST A SHINY NEW TRUCK...



We already offer you the most offloading solutions in the industry, and can custom build our vacuum loaders to suit your exact needs. We can help you find financing. And, with our Right Start program, we personally deliver the keys, provide operator and safety training and give you all the information you need to be more productive from the very beginning.

Beyond that we support your new or hard-used old trucks with fast access to genuine Guzzler parts and a toll-free number you can call for application expertise. We also have regional FS Solution service centers that can provide anything from minor repairs and refurbishing to total rebuilds.

And because we want your business to shine as much as a new truck we will pass along customer referrals every chance we get.

For a demo of a shiny new truck\*, go to [www.guzzler.com](http://www.guzzler.com) today, or call 1-800-627-3171

\*Some qualifications apply.

©2008 Federal Signal Corporation. Listed on the NYSE by the symbol FSS.



# Keith Huber was Vacuum Truck Pioneer

By Jim Kneiszel

**K**eith L. Huber, a vacuum truck pioneer who played an integral role in growing the efficiency of the liquid waste industry, died May 29 in a tractor accident on his family farm in LaFayette, Ill. He was 67.

Huber's Gulfport, Miss., company, Keith Huber Inc., was started in 1982 with its first product, the Dominator vacuum truck, still a mainstay of the industry. The company would rise to be known as the largest independent manufacturer of vacuum loading equipment in the U.S.

Huber was killed when a tractor he was operating overturned on the farm where he grew up in northwestern Illinois.

At the time of the accident, Huber was restoring the farm to its appearance in the 1950s, according to Al Klaser, vice president of Keith Huber Inc.

"He was doing what he loved to do. It was his passion," Klaser said of Huber's restoration of the farm and a number of vintage Plymouths.

After growing up in Galva, Ill., Huber moved to the Gulf Coast and made his lasting mark in business. In addition to the vacuum truck business, Huber had extensive real estate holdings around Gulfport, including the 45-acre industrial park where the truck-building company is located, Klaser said.

One of Huber's innovations, the King Vac, became a go-to tool for pumpers in the late 1980s. In a 2004 interview with COLE Publishing, Huber said the King Vac "revolutionized vacuum equipment by producing both high air flow and deep vacuum. It was totally different from anything that had been done before."

The reputation of the King Vac was cemented in 1989 when it was discovered to be the perfect tool to unload skimmers that cleaned oil pulled from Alaska's Prince William Sound following the Exxon Valdez oil spill.

In 2004, Huber was recognized as one of a number of industry pioneers in a series of feature stories in COLE's *Pumper* and *Cleaner*. In the story, he recalled how his father released him from an obligation to work the family farm after one of Huber's tinkering projects yielded a popular snowmobile design. Huber had taken his snowmobile to the Minnesota State Fair, and quickly received more orders for the product than he could produce. So he sold the design and his inventory to Mallard Coach, which manufactured the snowmobile under the Sno-Wing brand.

"My father said, 'Son, you made more money with that one sale than your dad has in his entire life of farming, so I guess I'm going to have to let you do what you love to do,'" Huber recalled. He would say that he started tinkering with machinery as a child, then somewhere along the line figured out, "it came incredibly easy for me. I guess Beethoven was born with his innate ability and I was born with mine in machinery design."

Before he turned his attention to vacuum trucks, Huber was credited with creating the first production model electronically controlled four-wheel golf car.

Klaser said the company is poised to move forward to build on its founder's legacy. He credited Huber for putting capable people in place to carry the company forward.

"We're certainly going to miss him, but we're well-prepared to move forward," Klaser said. "We really don't expect to skip a beat, and that's the way he would have wanted it."

Memorials in Huber's name may be made to the Maxine Huber Memorial Summer Camp Fund at Messiah Lutheran Church, 317 SW Third St., Galva, IL 61434, or Palmer College of Chiropractic, 1000 Brady St., Davenport, IA 52803. ■



Keith L. Huber

## COBRA SEWER CLEANING HOSE

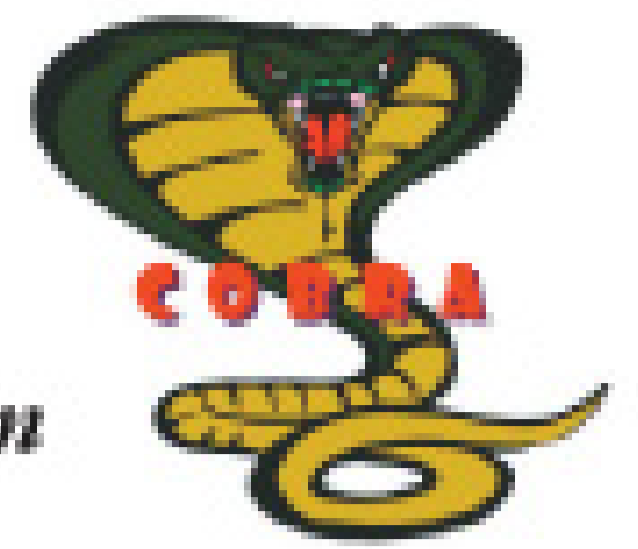

Bringing together 25 years of U.S. and European engineering/manufacturing technology.

**COBRA** Sewer Cleaning hose by **Poly-Flow** is engineered and manufactured to handle the toughest and most harsh conditions found in high-pressure sewer cleaning and jetting applications. **COBRA** features a tough polyether-urethane cover that offers maximum resistance to cutting, abrasion, various chemicals, and fungus. Cover colors conform to industry standards for maximum operating pressure ratings. For safety assurance, Cobra sewer cleaning hose is factory tested and sold as assemblies only.

To locate your nearest distributor contact us....

(503) 493-0015

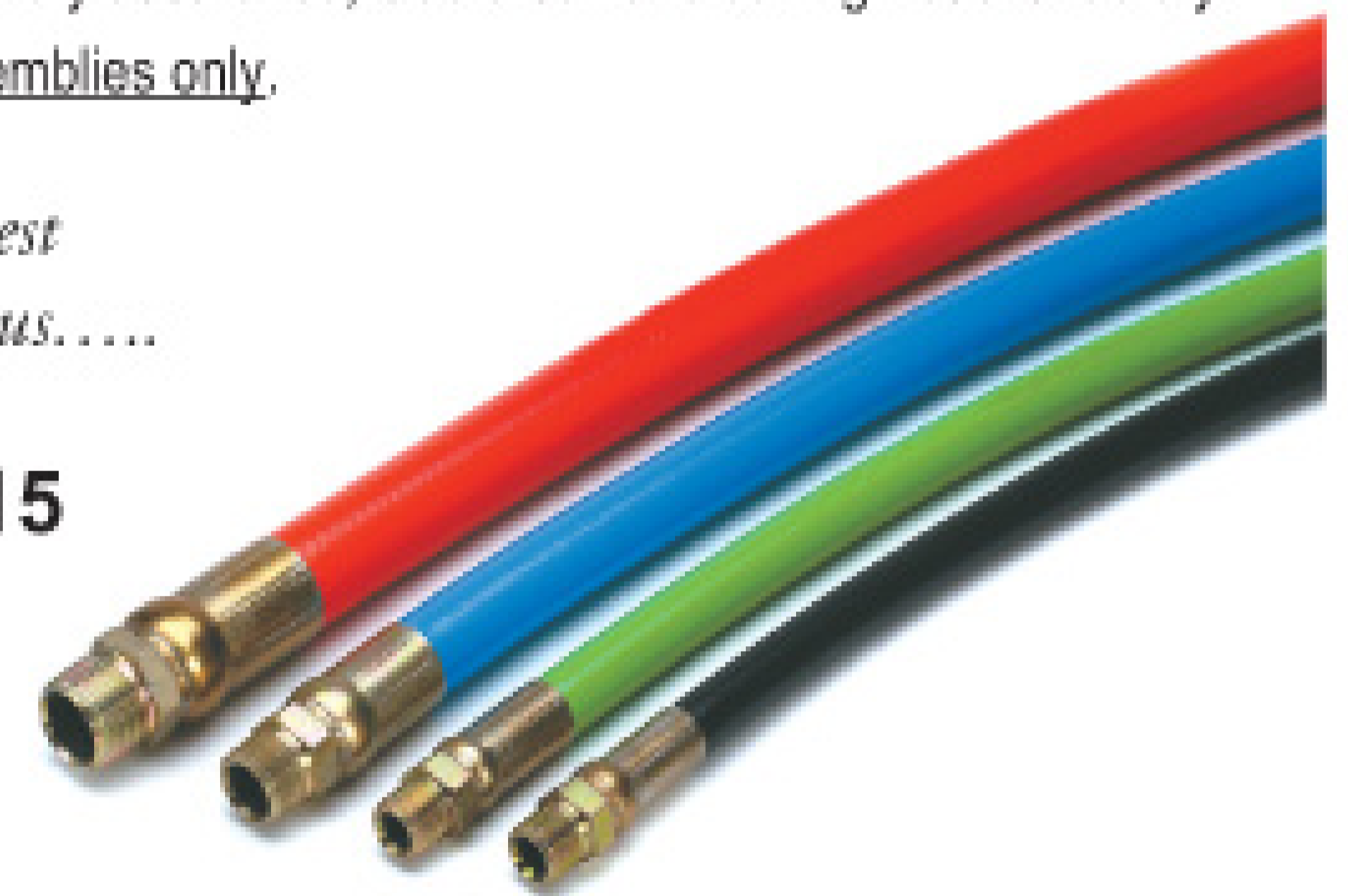

All Cobra products are manufactured in accordance with WASTEC specifications.



THE P/2000 Supertruck

## The Ultimate Service Vehicle



1-800-763-0700 ext. 2317 or visit [www.hackneyplumbing.com](http://www.hackneyplumbing.com)

# NEW!

## BUS WRAP GRAPHIC DESIGN



### PERMA-LATERAL™ LINING SYSTEM



before

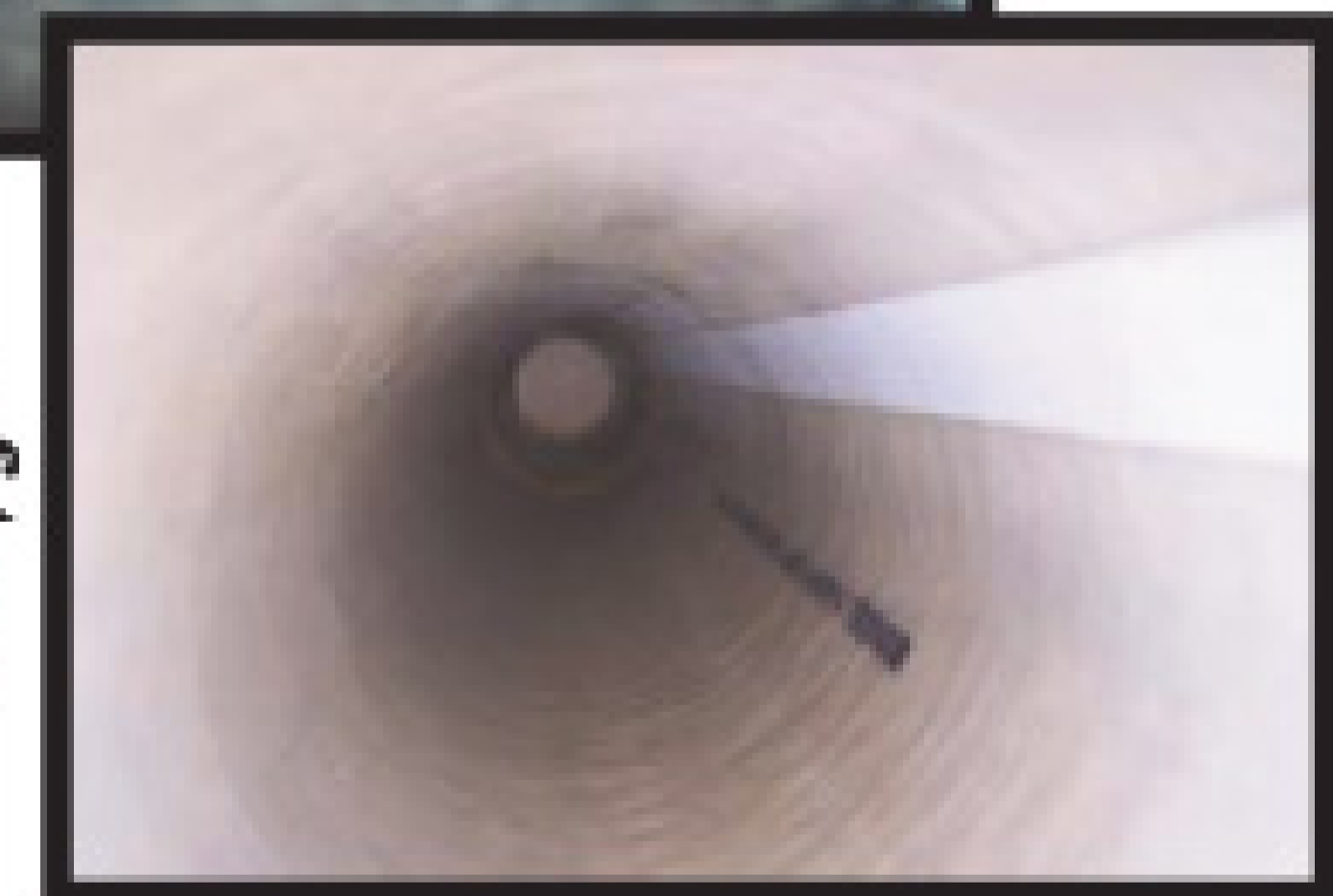

after

- Liner Cures Without External Heat Source
- NSF and IAPMO Certified
- Permanently Stops Root Intrusion
- Seamless/Jointless From Beginning to End

## VISIT US IN FLORIDA FOR OUR JULY OPEN HOUSE

### JULY 16TH, 17TH & 18TH LIVE, IN-FIELD DEMONSTRATIONS ON LATERAL, POINT REPAIR & INNERSEAL SYSTEM

## PERMA-LINER™ INDUSTRIES, INC.

1-866-336-2568 TOLL FREE

1-727-507-9749 INT'L

1-727-507-9849

WWW.PERMA-LINER.COM



# Don't Bust Your Balls!

GET A FREE RUPTURE DISC\* DEMONSTRATION VIDEO!

1.800.728.3842  
or

RuptureDisc@cherneind.com

## STOP OVER-INFLATION

- SAFEGUARD YOUR WORKERS
- PROTECT YOUR INVESTMENT

WITH CHERNE'S  
NEW RUPTURE DISC  
TECHNOLOGY\*

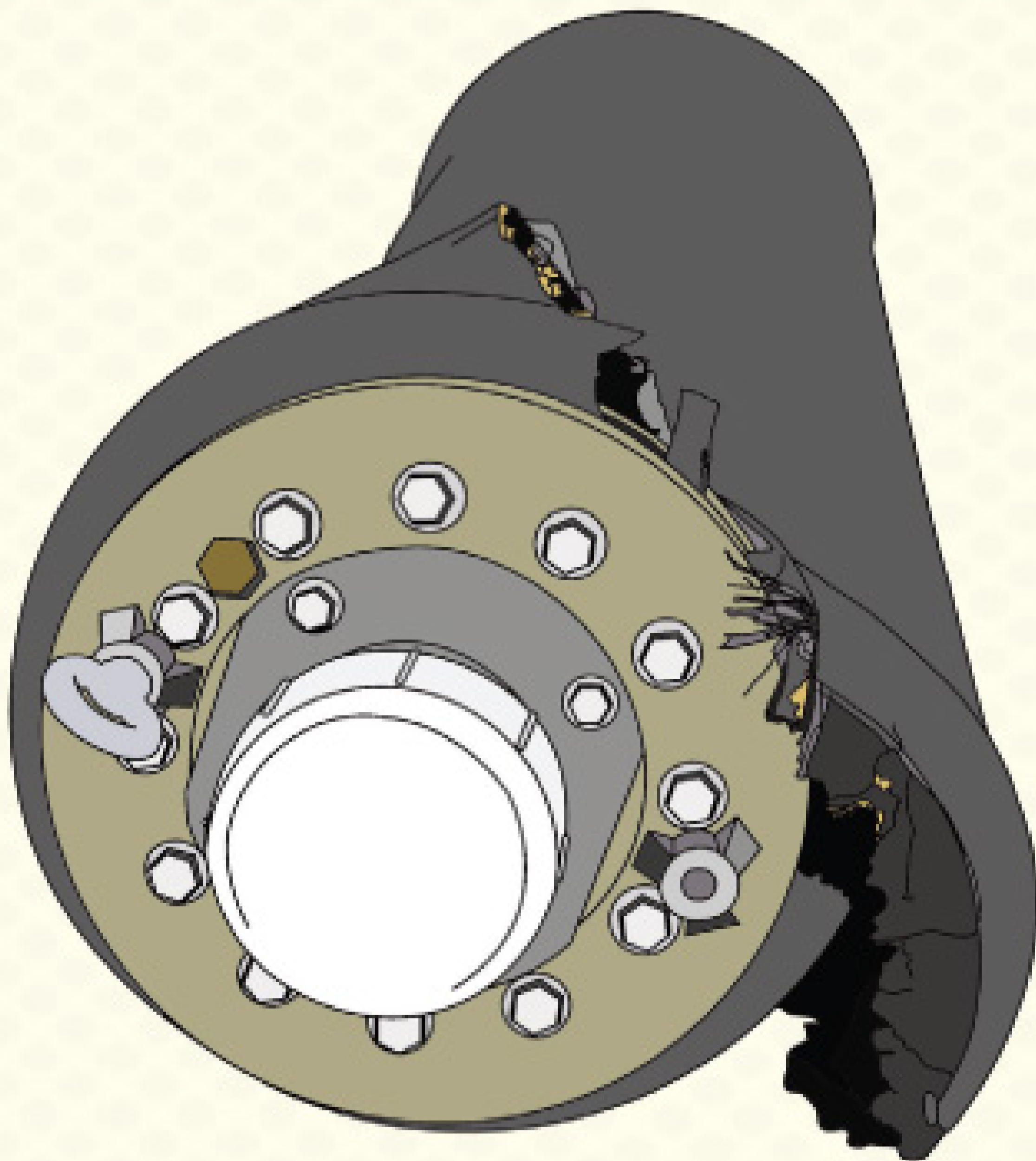

PLUGS TO 96"  
DEFLECTION GAUGES  
JOINT TESTERS  
SEWER AIR TEST EQUIPMENT  
SMOKE TESTING EQUIPMENT  
HYDROSTATIC TEST PUMPS

YOUR #1 SOURCE FOR  
SEWER PLUGS  
AND  
TESTING EQUIPMENT

\*Patent Pending



Cherne Industries Inc. - Minneapolis, MN USA  
1.800.THE PLUG - www.cherneind.com

# ENGINEERED TO LAST

We Train Installers



We Sell Tools

## MR. MANHOLE

MANHOLE LEVELING SYSTEM



PHONE: 419-229-3015 WWW.MRMANHOLE.COM

## SEWER Equipment & Supplies

Custom built  
hydro jetting  
units with  
flows over  
36 GPM  
and  
pressures up  
to 6000 PSI

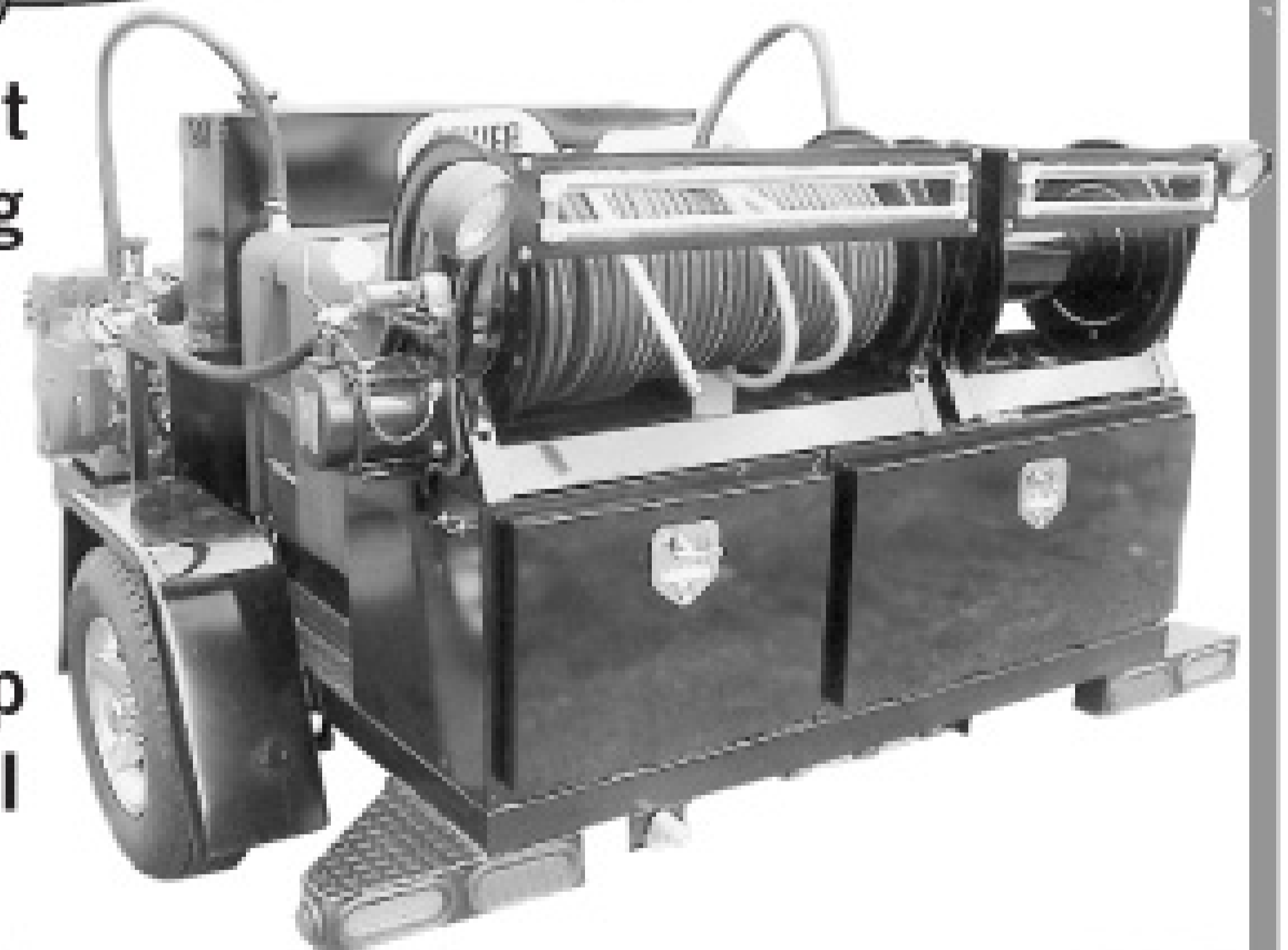

Trailers • Enclosed Units • Gas Powered Carts • Skid/Van Units • Electric Units • Roses • Nozzles & Much More.

T - 1440-200	14 GPM @ 4000 PSI starting at \$15,000
T - 1640-200	16 GPM @ 4000 PSI starting at \$16,999
T - 2030-300	20 GPM @ 3000 PSI starting at \$17,999
T - 1325-200	12.5 GPM @ 2500 PSI starting at \$8,999

Gas • Diesel • Anti-Freeze Systems • Large Capacity Reels & More  
We offer over 30 different models and have units starting at \$7,300

For all your jetting needs please call 202-330-8395  
www.sewerequipmentandsupplies.com

# Triple the Value of Your Inspection Budget.

## Side-Scanning Is up to 3 Times Faster than Video Inspection.

With side-scanning, you capture footage at speeds up to 70 feet/minute without stopping to pan, tilt or zoom. And side-scanning generates detailed flat scans that can be reviewed and annotated in a fraction the time.

With all the time and money side-scanning saves, be sure to demand a system that handles all your pipe—no matter the material, condition and size. DigiSewer for ROVER is the only side-scanner that adapts to real-world conditions, and the only one that also supports traditional CCTV inspection, giving you total versatility for your investment.

Best of all, DigiSewer remains the leading innovator in side-scanning, offering features like virtual pan/tilt, inclination graphing, joint/tap auto-recognition, PACP color-coding, and full WinCan integration.

Adjustable camera height ensures centerline view and even illumination.



**DIGISEWER**  
Side-Scanning for **ROVER**.



For special applications, rent larger or smaller ROVER crawler bodies to work with your system.

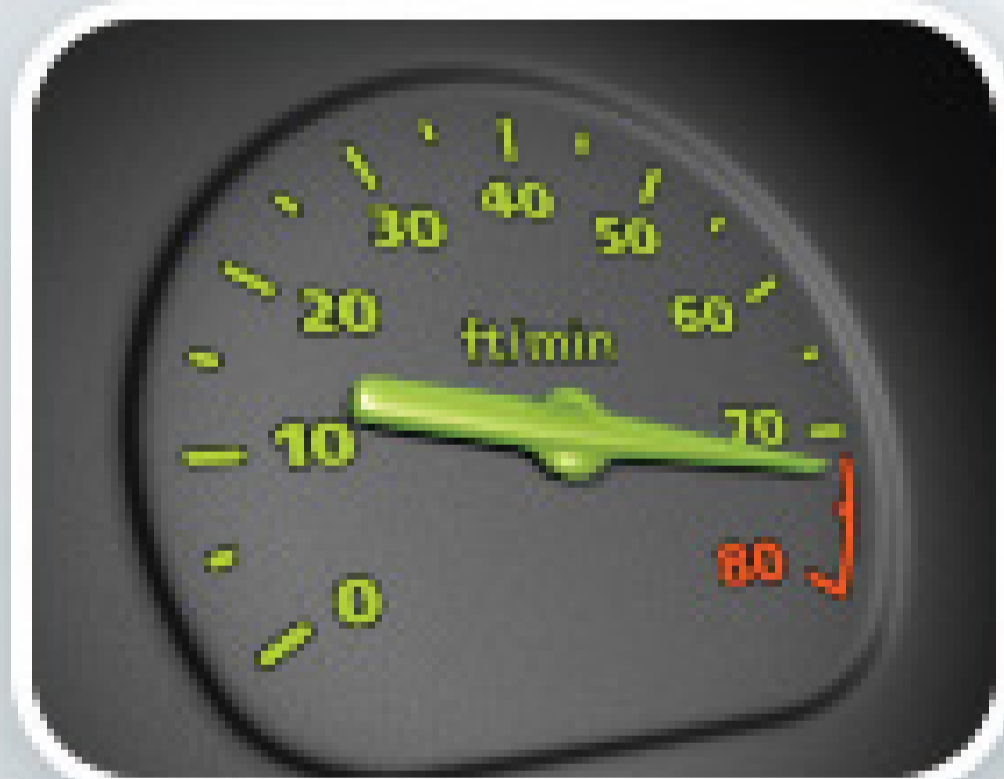

Side-scanning at speeds up to 70 fpm.



Virtual pan/tilt with no cable in view.

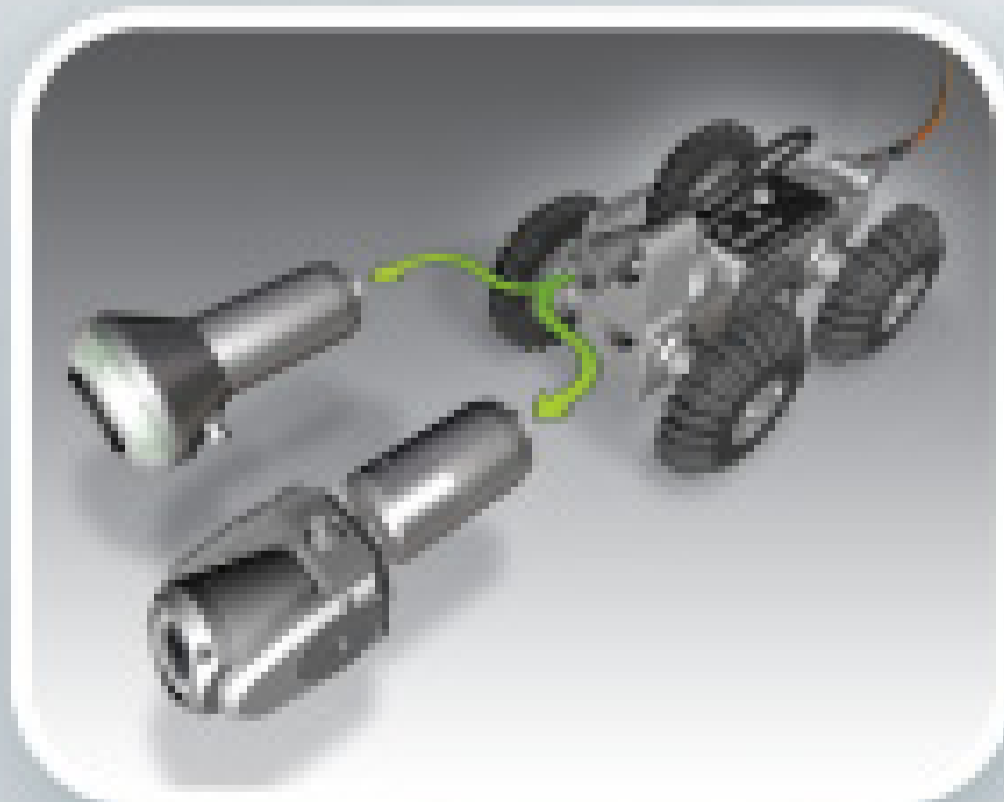

Side-scanning and video inspection in a single system.

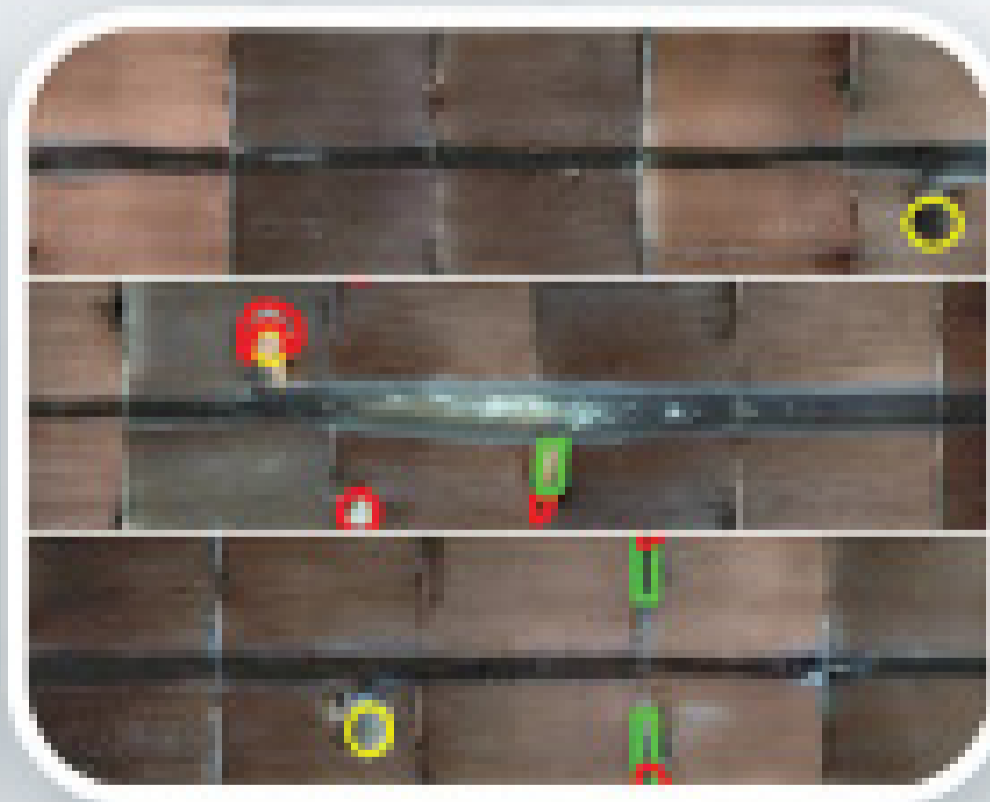

Quick analysis of entire section with PACP color-coding.



Comprehensive WinCan integration.

Interchangeable wheels address a broad array of pipe sizes, materials and conditions.



### OWNER ADVANTAGE

- ▶ \$1000 EnviroSight Credit with DigiSewer Purchase†
- ▶ Camera Trade-In Options
- ▶ Discount Privileges
- ▶ Largest Network of Regional Service Centers Across North America

[www.envirosight.com](http://www.envirosight.com) • (866) 936-8476 • fax (973) 252-1176  
Headquarters: Randolph, New Jersey • Sales & Service Offices Worldwide

**Envirosight** LLC  
SPECIALISTS IN PIPELINE INSPECTION

†Credit can be applied toward future purchases. DigiSewer included. Offer valid until 1/1/09. DigiSewer, ROVER, EnviroSight and their respective logos are trademarks of EnviroSight, LLC. ©2008 EnviroSight, LLC. All rights reserved. DigiSewer carries patent 7,164,476. WinCan is a trademark of CDI-Lab.

# In the Zone

Roadway work zone safety means staying focused and avoiding distractions

By Scottie Dayton

Everyone knows parts of the United States and Canada have two seasons: winter and road construction. Your employees can easily become upset and distracted when the dreaded orange barrels impede their progress to a service call — especially if it's an emergency — or the highway becomes a one-lane parking lot.

The U.S. National Highway System expects at least 3,000 work zones, or one every 100 miles, during the peak of this construction season. Most of us assume that highway workers are the people at risk, but of the 1,010 persons killed in work zones in 2006, 85 percent were drivers or vehicle occupants. According to Federal Highway Administration statistics, 160 work zone injuries occur daily — one every nine min-

utes. A fatality occurs every 8.7 hours, almost three a day.

## Fighting back

Work zone deaths and injuries have increased because of more construction projects and inattentive driving in heavy traffic. Employers, however, can help their workers overcome the frustration and impatience that road construction delays often generate by stressing that they

Safety  
FIRST

are responsible for making lifesaving decisions.

"Put yourself on high alert," advises Barbara Manning Grimm,

editor of *Safety Smart! Online*. "Be aware of your surroundings, including the construction activity, signs, signals, and flagger instructions."

Your company's driver safety program probably stresses the dangers of speeding, but make your employees aware also that speed is a major cause of work zone crashes, and that rear-end collisions are the most common type of crash. If your drivers can't avoid work zones, have dispatchers schedule enough time to compensate for delays.

Advise drivers especially not to make cell phone calls or switch the tune on the radio or CD player while driving through a work zone. Because construction activities change continually (the work and equipment are often the biggest distraction), employees must pay extra attention to the road ahead and be alert for any obstacles.

"Hazards develop unexpectedly, such as loads on trucks and buckets on backhoes extending suddenly into your lane," says Grimm.

"Watch what's going on around you. Be prepared to take action quickly. Gear down if necessary, and stay ready to brake. Check your rearview mirror to see if other vehicles are slowing accordingly. If not, flash your brake lights."

## Slow for the cone zone

Remind your drivers not to exceed the posted speed limit, as

finer for speeding in work zones are hefty. They should follow speed limits even if they do not see anyone working; otherwise, they could be going too fast to negotiate narrow lanes, sudden turns, and rough road surfaces. Stress that you expect your drivers to be patient and stay calm, enabling them and the people building the roads to make it home safely.

**"Hazards develop unexpectedly, such as loads on trucks and buckets on backhoes extending suddenly into your lane. Watch what's going on around you."**

**Barbara Manning Grimm**

The National Work Zone Safety Information Clearinghouse has a free Know the Signs poster that illustrates various work zone safety signs your drivers will encounter. Contact [lmcliskey@artba.org](mailto:lmcliskey@artba.org) to order it.

Employees comfortable with computers can take a short quiz offered by the Federal Highway Administration on what the signs, signals, and cones mean. Go to [www.workzonedriver.org/index.htm](http://www.workzonedriver.org/index.htm), click the For Teens tab, then Know the Signs. Drivers of all experience levels will benefit from the review. ■

**Call Toll Free - 800-356-9661**



**Triple R Specialty**

**MODEL 3010 TRAILER JETTER**



**WE CAN HANDLE ANY JETTER CONFIGURATION!**

**MODEL JE-15 PORTABLE JETTER**



**MODEL JG-30 PORTABLE JETTER**



**www.triplerspecialty.com**

## TRY TEK Machine Works, Inc.

**FAST DELIVERY**  
on  
replacement parts

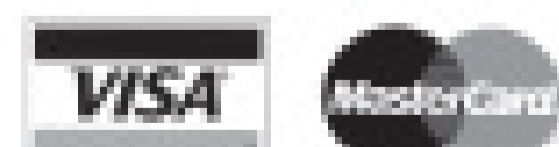

We accept VISA or MasterCard



Contact us for more information:  
**Phone: 717-428-1477**  
Fax: 717-428-2865  
Email: [trytek@trytek.com](mailto:trytek@trytek.com)

250 N. Main St.  
Jacobus, PA 17407  
USA

**Hundreds  
in use!**

**www.trytek.com**  
**6" to 15" Tap Cutter**

Serving the  
industry for  
**21 years**



# Healing Power

It's time to turn to Jetstream. Again

**Jetstream**, the name that made believers everywhere with the world's first waterblaster to provide a true 10k to 40k conversion ...

**Jetstream**, the name that gave you peace of mind with its simplicity and power ...

**Jetstream is ready to heal your pain.**

**No more short accessory life due to dirty water.** With the Jetstream X-Series, you have new reason for faith—a water tank system that's nothing short of miraculous. By filtering early, the Jetstream X-Series frees water of dirt and contaminants before it reaches the pump, increasing the life of your pump, hose and accessories.

**No more trips to the shop to change pressure.**

Jetstream X-Series units can be converted in the field from 10,000 or 20,000 psi to 40,000 psi.

And the healing power of Jetstream keeps the pain at bay—with ease of operation, ease of service, increased fuel efficiency and greater productivity.



*Join us where the water flows pure. Come to Jetstream. Experience the healing power of the X-Series.*

*For a demonstration, call **1-800/231-8192** or visit **[www.waterblast.com](http://www.waterblast.com)**.*

**Jetstream**<sup>®</sup>  
Subsidiary of Federal Signal Corporation

©2007 Federal Signal Corporation, listed on the NYSE by the symbol FSS.



# Data = Profits



**PACP 4.2**

Accurate and concise data generates the revenues for the Contractor today. Cobra understands the importance of data and your need to deliver the best possible data to your client.

## Imagine...

... a simple, fast and accurate Data Collection System, more efficient for your operators than you ever thought possible, fully debugged with no costly upgrades. Imagine an integrated PACP manual at your operators' fingertips prompting correct data entry every time, saving time/money by eliminating QA/QC editing. Imagine a Data Collection System with no more "Gotcha's".

Call us today for a data collection system to meet the varying data needs of your clients.

*You'll be glad you did!*



www.cobratec.com

4806 Wright Drive Bldg. C  
Smyrna, GA 30082

Sales: 800.443.3761  
E-mail: sales@cobratec.com

10-40K psi

SINCE 1975



WATERBLAST EQUIPMENT SPECIALISTS

Gardner Denver  
Jetstream  
NLB  
Flow Husky  
Aqua-Dyne  
American Weatherford



CUSTOMER SATISFACTION GUARANTEED.  
IF WE DON'T HAVE IT - WE CAN GET IT!

"Let us select the right equipment for your project"

**800-327-6799**  
**www.blasters.net**

"We have the Experience as Contractors and the solutions you need."

**SALES • RENTALS • CONTRACTING • ENGINEERED SYSTEMS**

**NEW & USED WATERBLASTER SALES 10-40K psi**  
**WATERBLASTER RENTALS WITH TECHNICAL SUPPORT**  
**TRAINED EXPERIENCED OPERATORS ALSO AVAILABLE**  
**PARTS & ACCESSORIES SALES**  
**WE BUY USED PUMPS**  
**TRADE-INS • ALL BRANDS**

*We're Growing Again ..... Applicants Welcome!*

# Wolf Creek Co.

Original Bauer

Portable Piping

Bauer Fittings

Polybarb™ Pipe & Tails

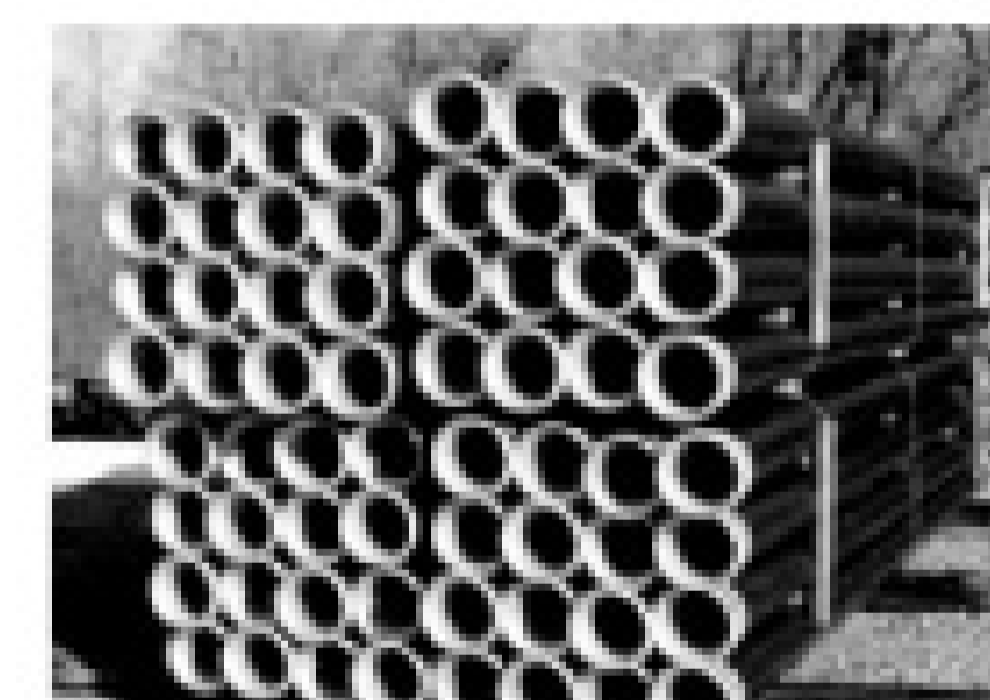

Polybarb™ HDPE pipes and fusible tails available in 4" to 12" diameters up to 40' in length.

Available in weldable, hose insert, and flanged connections. Fittings available from 2" to 12".

Industrial Vac Tubes

We can fabricate aluminum vacuum evacuation or suction tubes per your specifications. Using the Bauer Coupler or Anfor Coupler.

Bauer Pipe



Galvanized piping available in 2" to 12"

800.488.7305 • www.wolfcreekcompany.com

# ***OLDEST NAME IN THE BUSINESS*** ***— Over 100 YEARS OLD —***

**Call for the lowest prices on General Machines...  
 ...I'd give them away, but my wife won't let me, SHE'S CRAZY!**

***Now Available***



**CALL FOR GENERAL SPECIALS**

***Repair Center for:***

**Ridgid SeeSnake, Gen-Eye,  
 Radiodetection, Vision Technology,  
 Electric Eel & Spartan Cameras  
 Fast Turnaround Time**

**Special pricing on all General jetters, cameras and machines**



***Root Rat*** *root cutter nozzle*

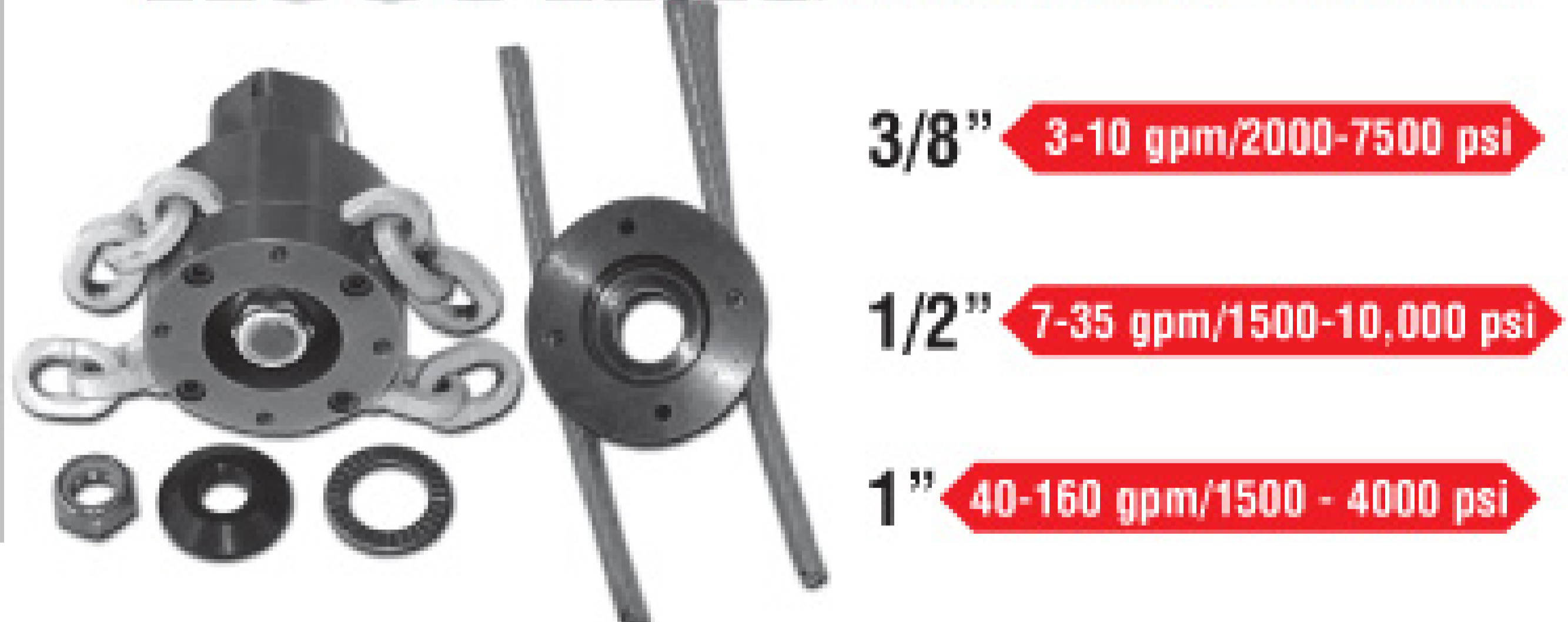

**Allan J. Coleman Co., Since 1905 - Call us today! 773-728-2400**

**"THESE PRODUCTS ARE SO GOOD, WE GIVE YOU OUR ADDRESS!"**

5725 North Ravenswood Avenue • Chicago, IL 60660 • [www.allanjcoleman.com](http://www.allanjcoleman.com)

**PHCC MEMBER**

# ProCam™ DVD

Color Mini Camera Inspection System with DVD Player/Recorder

- 10.4" Color LCD Monitor
- 110 VAC or 12 VDC Operation
- Power Control Unit Weighs Only 17 Pounds
- Optional Rechargeable Battery Pack Kit Available
- Optional Pro Eye Color Self-Leveling Camera Available



## Optional Rechargeable Battery Pack Kit Includes:

- (1) 14.4 V NiMH Environmentally Friendly Battery
- Dual Bay Fast Charger with Carrying Case
- Additional Batteries Available
- Charges on Both AC & DC



ProCam DVD Ultra  
with Reel & Optional  
Battery Pack Kit

**UEMSI**  
PIPELINE CLEANING & TELEVISION EQUIPMENT

Corporate Office: 1.800.666.0766 • Fax 1.800.691.0031  
www.uemsi.com • E-mail: info@uemsi.com

We Accept:

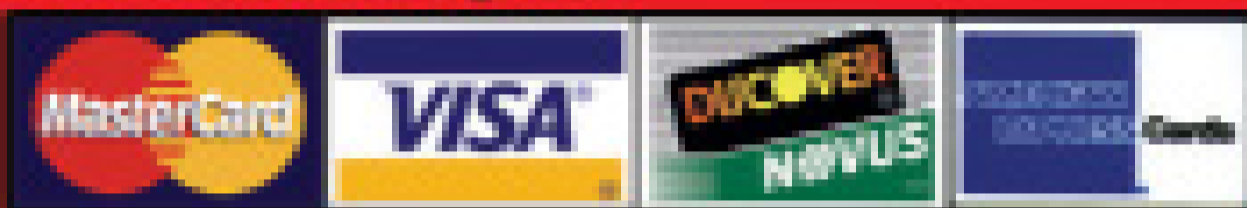

# Pulsar 2000 Line Tracer

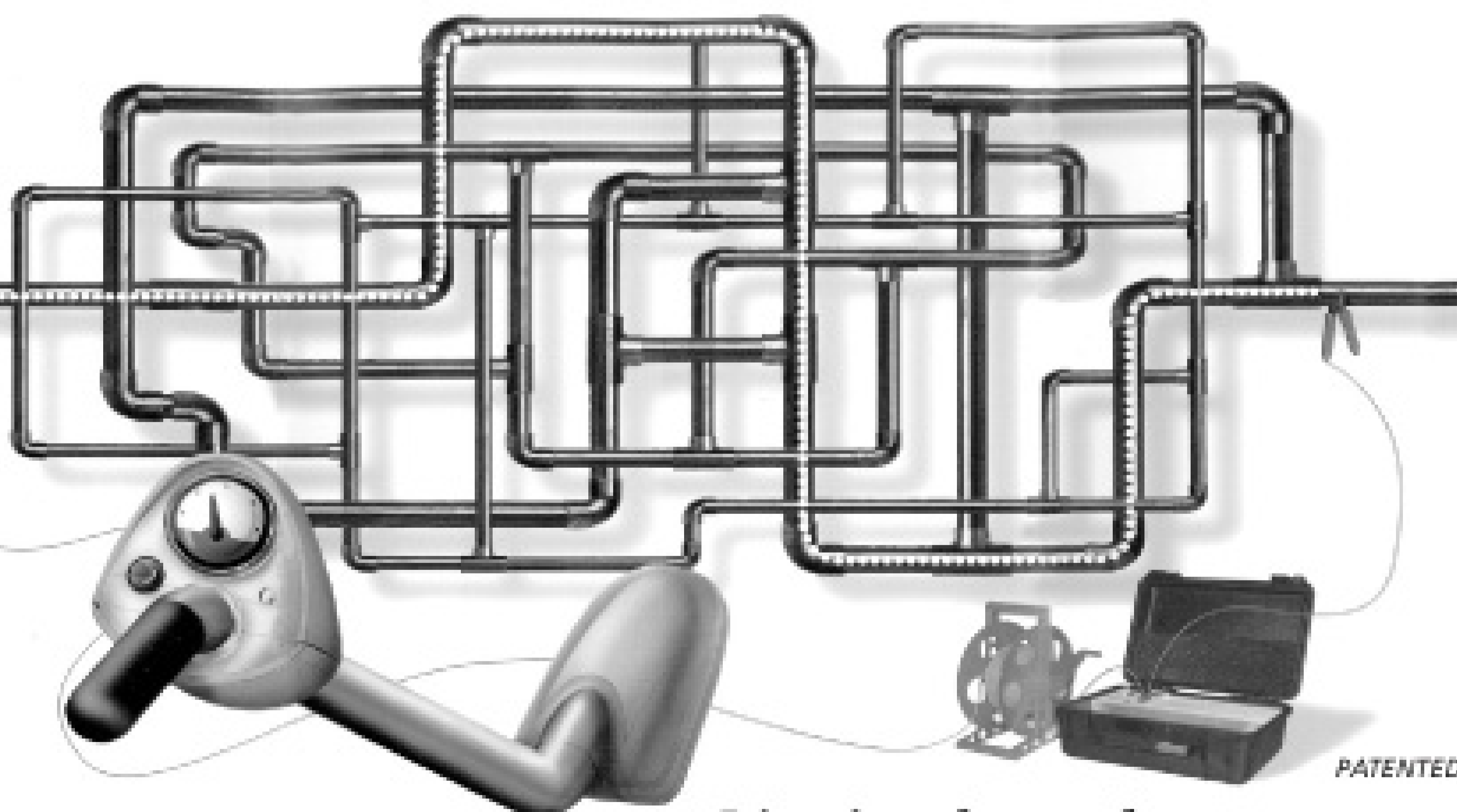

*It's a jungle out there.*

Locate Lines • Locate Water Leaks • Training Video

[www.Pulsar2000.com](http://www.Pulsar2000.com)

DISTRIBUTORS WANTED



The Pulsar 2000 line tracer is designed primarily to locate metallic pipes. The Pulsar 2000 is a directional line tracer. Connect the Pulsar's powerful and unique transmitter to your target pipe and locate only that pipe. Locating can be accomplished under floors, in walls and in ceilings. The Pulsar 2000 does not require grounding.

**Leak detection personnel...** The Pulsar 2000 is a **must have** locator. Now you can quickly identify the pipe location, thereby reducing the search area of the leak.

**100% satisfaction guarantee...** We are so sure that you will see the time saving benefit of the Pulsar 2000, we will let you return it for a full refund if you are not satisfied. If you want to learn more about the Pulsar 2000 and our leak locating equipment, please call **1-888-752-5463** or e-mail [jsmll@aol.com](mailto:jsmll@aol.com) for a **free** demonstration video or CD and references of satisfied customers.

We have been using the Pulsar 2000 along with the XL2 fluid detector and Geophones since January 1989 in our leak locating business. Our leak locates are **accurate 95% of the time**, but I can honestly say, the line we trace is always there. Our equipment is user-friendly and requires very little training, as you will see on the video. Purchase the Pulsar 2000 line tracer, XL2 fluid detector and Geophones, and start locating leaks immediately.

# CABLE DRAIN CLEANERS

# TRENCHLESS SYSTEMS

# HIGH PRESSURE WATER JETTERS

Model GO 68HD



Model GO 50



Model GO 380



Model GO 15



Model GO 40

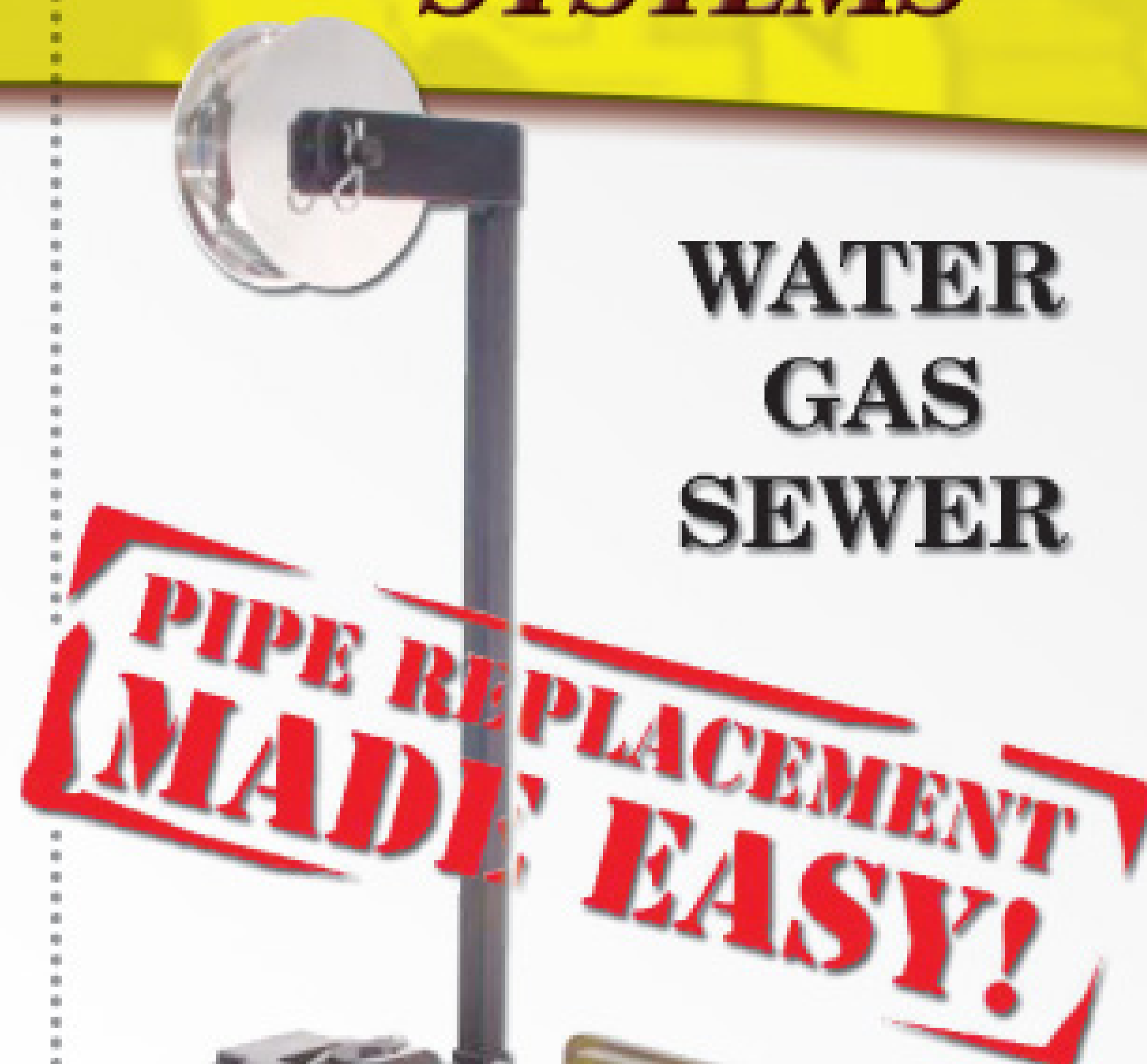

WATER  
GAS  
SEWER

PIPE REPLACEMENT  
MADE EASY!

Chain System

Wire Rope System



Model GO 3500



Model GO 1500



Model GO 1500A



**GORLITZ** SEWER & DRAIN **INC.**

10132 NORWALK BLVD.  
SANTA FE SPRINGS CA 90670

TEL (562) 944-3060

FAX (562) 944-7630

WEB: [HTTP://WWW.GORLITZ.COM](http://www.gorlitz.com)

EMAIL: [GORLITZ@IX.NETCOM.COM](mailto:GORLITZ@IX.NETCOM.COM)

One Word. Cool.



Operating up to 15°F cooler than the competition, the new Gardner Denver Sutorbilt® Legend® DSL Series is raising cool to a new level. Integral ribs, air gaps and lube channels are all part of the innovative "cooling" process that results in extended bearing life and ultimate blower reliability.

Proven results make it legendary. Advanced technology makes it cool. Gardner Denver makes it a reality.



GD Sutorbilt® Legend® DSL Series – Dual Splash Lubrication



Experience Proven Results

www.GardnerDenverProducts.com  
pd.blowers@gardnerdenver.com • 800.682.9868

# VSI

## VACUUM SALES, INC.

51 STONE RD. • LINDENWOLD, NJ 08021  
Low Interest Rate Financing Available!



Stock # 13234  
Pipehunter Truck

mounted jetting unit, 3,000 psi at 50 gpm with a 1,000 U.S. gallons water tank, rear mounted hose reel with a Jet Eye Camera system mounted on a 2006 GMC TC6500 cab & chassis. Less than 6,000 miles. Special Pumper & Cleaner Environmental Expo Pricing \$179,000

**888.VAC.UNIT** (888.822.8648)  
**www.VacuumSalesInc.com**

**Sales, Parts & Service**

## Your Source For: The Best Quality Products & Emerging Technologies



Rely on us for the best in:

- Water Leak Detectors
- Gas Detectors
- Line Locators
- Fall Protection
- Video Inspection

**We Sell The Tools That Work!**

Call for more information.

**800.992.0222**

Order online 24/7 - [www.advancedworld.com](http://www.advancedworld.com)



# The Ultimate in Inspection Software

# WinCan v8™

## Core License

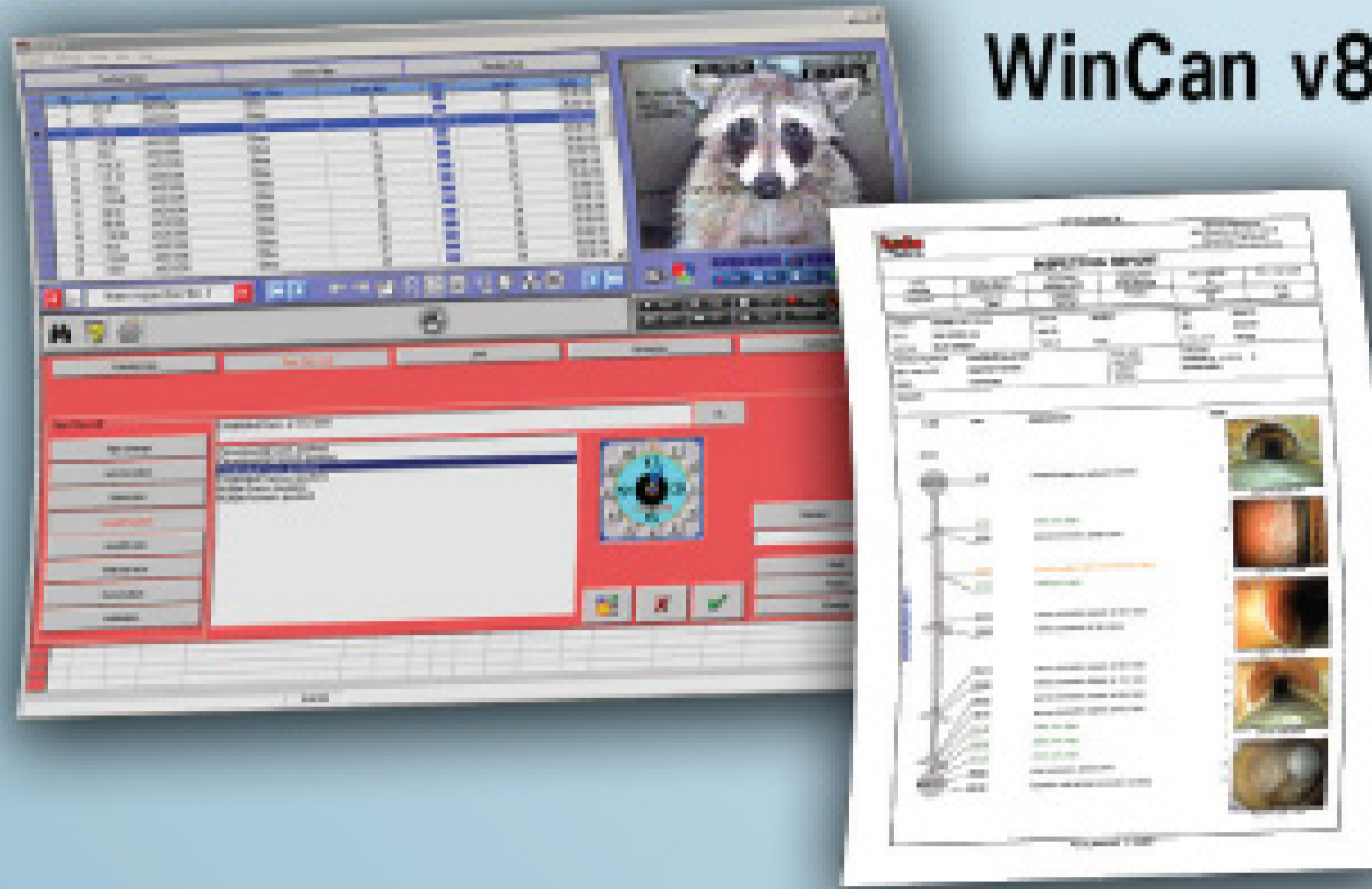

WinCan v8 is easy to use and yet still comprehensive, WinCan v8 includes data entry, picture capture, data filtering, and merging, all as part of the Core license.

## GIS Modules

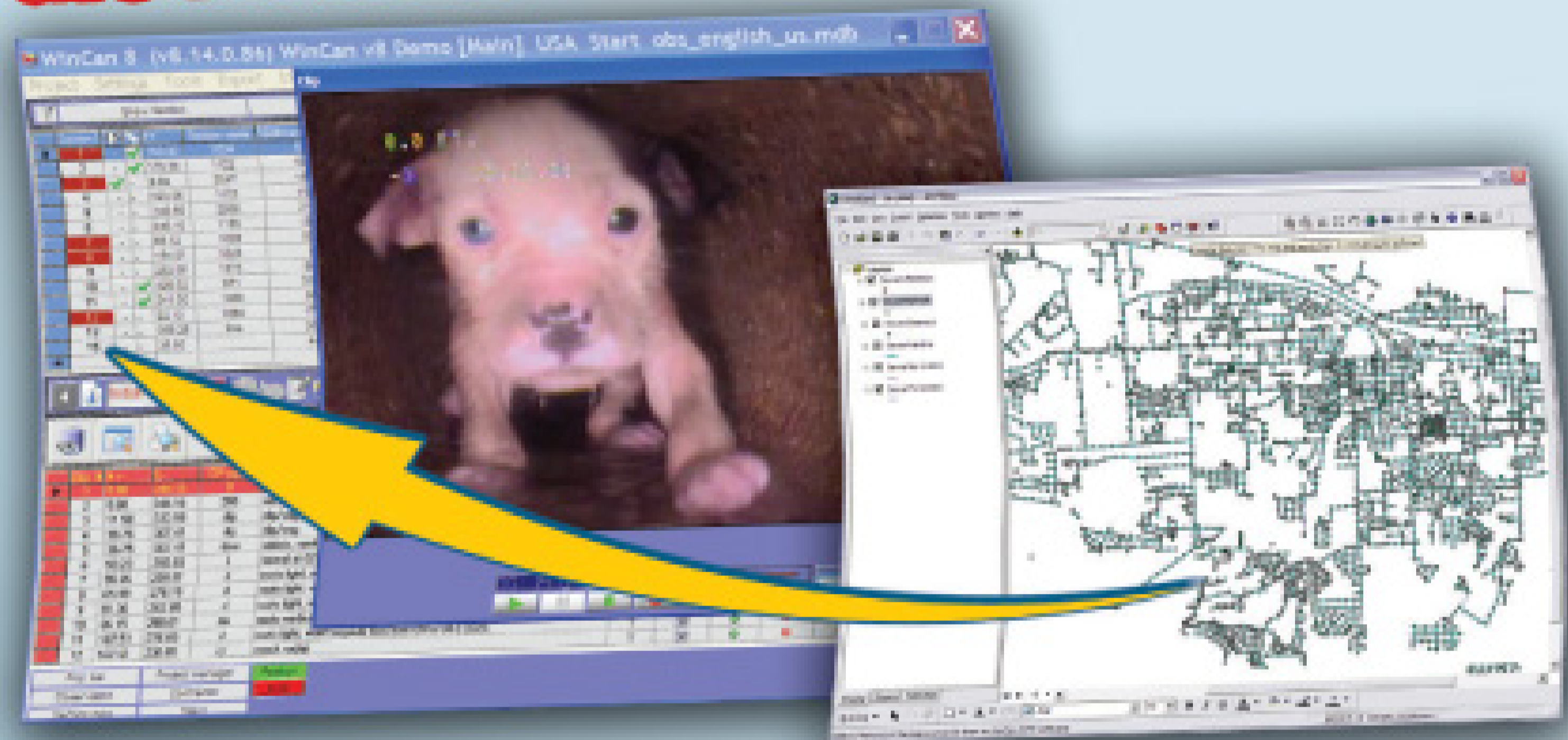

GIS Query tools and WinCan's fully-open ODBC database let you use WinCan data with your GIS to query data, join tables into the GIS, and even complete a full comprehensive data upload.

## WinCan Map

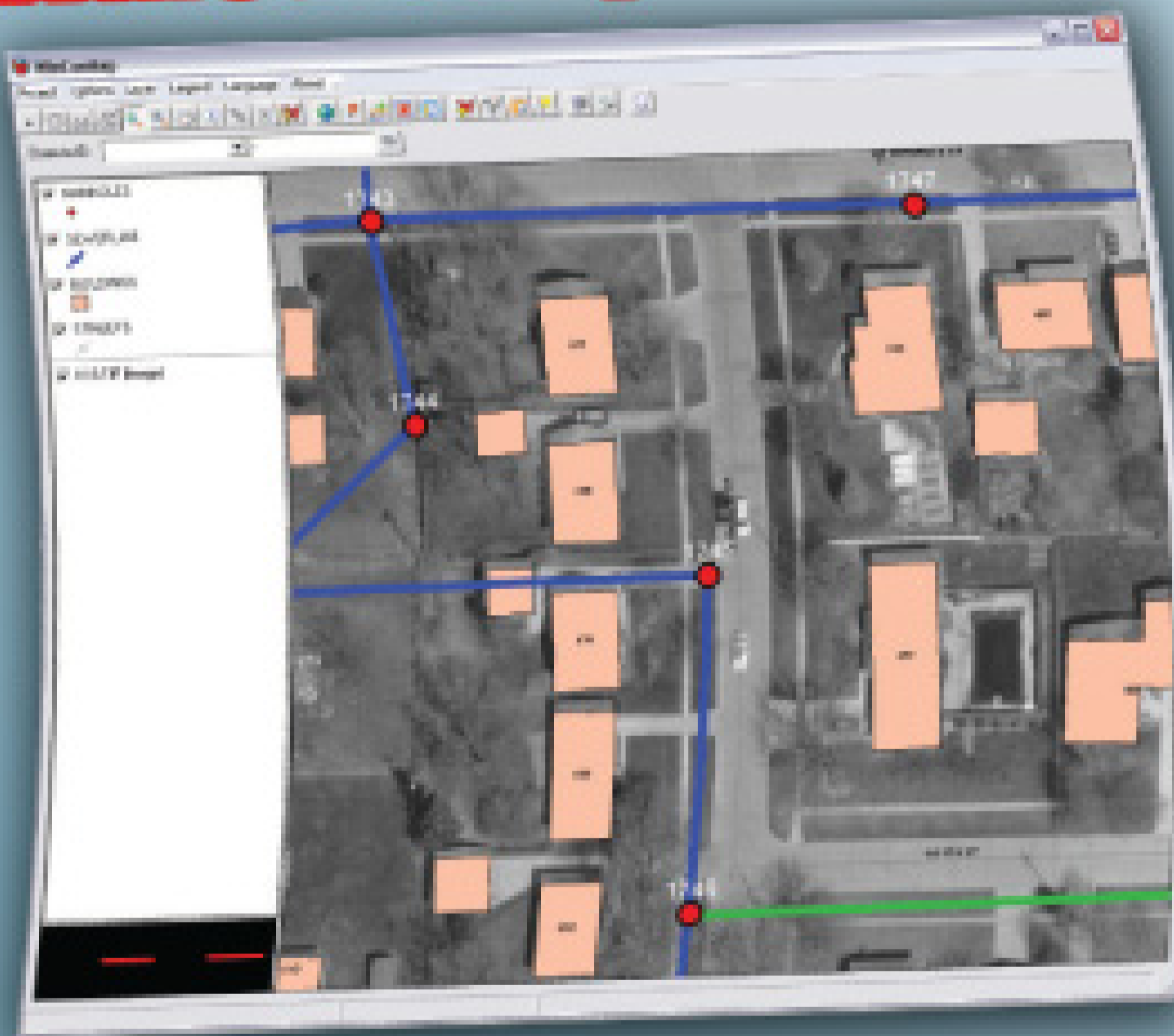

Map works with any GIS application. Map tools allow you to transfer data into WinCan, click on an asset to find the coordinating inspection in WinCan or click on the inspection to highlight the asset on the map.

**Online Demonstrations are available every Monday at 1 pm and Friday at 9 am. Email [lesley.escobar@wincanamerica.com](mailto:lesley.escobar@wincanamerica.com) to schedule a presentation.**



**505.341.0109**

[www.wincanamerica.com](http://www.wincanamerica.com)

Look for your WinCan America Authorized Dealer!

© 2008 WinCan America and WinCan America. All rights reserved. WinCan and the WinCan Logo are trademarks of WinCan America.

# 10 Ways to Hurt Your Business

If you want to make life in business tougher than it needs to be, here are ten good prescriptions to try on a regular basis

By Erik Gunn

**M**uch of what goes wrong in the world or in business can be blamed on bad decisions. Yes, natural disasters and other events happen that no one can control. But even when those happen, just how well we cope with the aftermath may depend on how carefully we thought things through in advance.

Too often, we go on automatic pilot and just plain don't think about the consequences of our actions. If you're the parent of a teenager — in fact, if you just follow the news — you already know this. But let's be honest with ourselves: all of us can make this mistake, and not just teens or politicians.

There are some foolish mistakes in business that people make time after time, even though it seems they should know better. Here are a few of them. Let's call them ten ways to hurt your business.

**10. Buy something just because "it's deductible."** Ahh, deductibility. That may be the most insidious seducer of fledgling business owners — and many experienced business people fall for it, too.

While it's true that every legitimate business expense reduces the income on which you pay taxes, we often forget the other half of the story: Every dollar you incur in expenses first has to be earned as revenue. Remember, too: For each dollar you spent on that thing you didn't need, the tax deduction got you only 20 or 30 cents back.

**9. Don't take credit cards.** So you think

letting customers pay with plastic is too risky, or requires too much work, or costs too much because the credit card company takes a cut from every sale? Fine. Just don't think about how much more it costs when your competitor gets more business from the growing number of customers who use credit or debit cards to pay bills — especially the ones in three figures or more.

**8. Rely too much on credit card debt.** Used carefully, credit card debt can help you smooth your cash flow. And with low- or no-interest teaser rates, you can cut the cost of that debt to virtually nothing. The danger is getting over your head. Don't take on this kind of debt — if fact, don't take on any kind of debt — without making sure you can pay it down in time to avoid huge interest expenses.

**7. Cut your prices just to beat the competition.** Face it: If all you're competing on is price, there's always someone who can charge less money. Yes, you have to pay attention to market prices for your services, but if you're going to stay in business, what you really need to do is make sure you deliver value that brings good customers back.

**6. Save money by not advertising.** No question, the media marketplace is changing as the Internet becomes a more important source of information. But old media — radio, TV, even newspapers — aren't dead yet. You know the old Bible verse about not hiding your light under a bushel. Not advertising is one way to snuff that candle right out.

**5. Under-insure (or over-insure) your business.** Not getting enough coverage can leave you vulnerable to a major catastrophe. But there's a flip side: spending money on more coverage than you need. That may be less damaging, of course, but who needs to leak revenue?

**4. Save money by not hiring a bookkeeper.** What's your No.1 job? Keeping the

Erik Gunn is a magazine writer and editor in Racine, Wis., where he operates Great Lakes Editorial Services, consulting for businesses, non-profits and individuals. Readers may direct inquiries to him by contacting this publication at 800/257-7222 or e-mailing [editor@cleaner.com](mailto:editor@cleaner.com).



business going by finding customers and delivering service. You can't do it all, no matter how small your operation. Keeping track of where the money comes from and where it goes is a critical job in any business. So find someone to track that for you. (And while you're at it, go out and retain a good accountant to help you map out the big picture financially.)

**3. Hire whoever comes in the door.** Yes, it can be tough to find good, skilled labor, but remember: You're in the service business. Savvy employers know that hiring the wrong person

**Yes, it can be tough to find good, skilled labor, but remember: You're in the service business. Savvy employers know that hiring the wrong person costs way too much — in training, in turnover, in low customer satisfaction.**

costs way too much — in training, in turnover, in low customer satisfaction. That's why they invest time in hiring people who fit their company.

Again there's a flip side: relying on overtime instead of adding the staff you need. Overtime is best used to get through busy times of short duration. In time, if you work your people too hard, they'll burn out.

**2. Don't get bids.** You don't need to be a stickler about making sure everything you buy is competitively priced. An hour spent shopping prices for paper or printer ink may cost you more than just buying those items in the most convenient place. But relying on the same old sources time and time again, for everything, is a good prescription for spending more than you need to.

**1. Don't have a plan.** The old saying goes: "If you don't know where you're going, any road will get you there." It's true. And if you count too much on winging it, you're pretty likely to fly right into the ground. But once again, don't over-compensate. A plan doesn't have to be etched in stone.

The best plans are flexible enough to change as circumstances warrant. And the simpler they are, the better. Because if you spend all your time planning, when are you going to do any business? ■



**Meyers®  
Pumps  
& Parts**

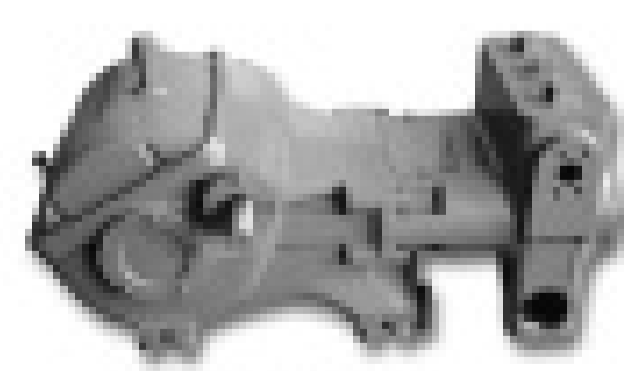

The DP Series Plunger Pump adds a new dimension of rugged strength and versatility for any demanding job.



The D45-20 High Pressure Reciprocating Pump is a high-volume, high pressure piston pump that can't be beat for sewer cleaning applications.

CALL US TODAY

WESTERN SALES, LLC

866-493-3406

711 Mission Avenue, Suite 303 • Oceanside, CA 92054  
Fax: 760-754-4915 • Email: [westernsales@cox.net](mailto:westernsales@cox.net)



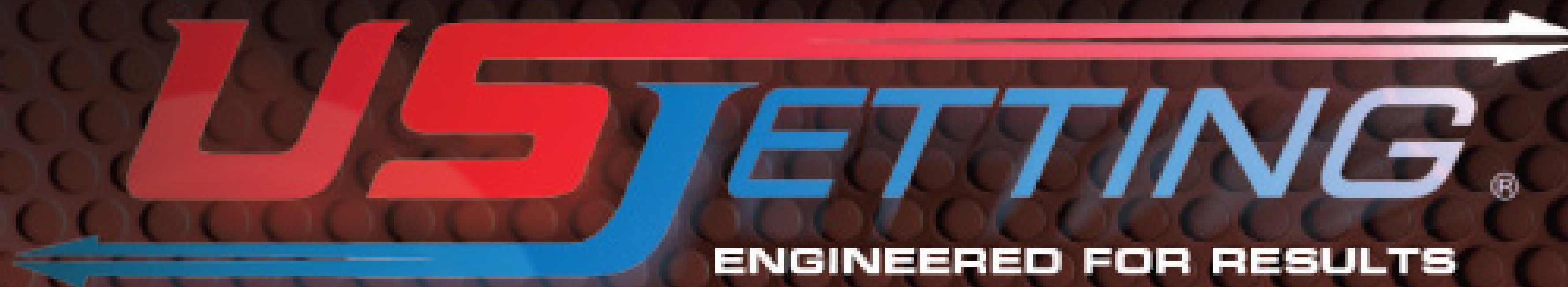

# THE 4018 300 TANDEM

(4000psi at 18gpm) (300 gal tank)

SO GOOD, THEY'RE SELLING ACROSS THE WORLD!



New generation control system with wireless remote

3 cylinder run dry pump/stainless steel fluid head

Well designed strong and durable tandem axle trailer

Pivoting hose reel with 500 ft hose (700 ft capacity)

Central mounted 180° rotating hydraulic reel

DOT approved polyethylene fuel/antifreeze tanks

LED lights with programmable flashing

Hard stainless steel piping on all fluid systems

Anti siphon fill system

USJ performance, endurance and reliability

THIS ONE IS THE FIRST  
OF SEVEN BEING DELIVERED  
TO SYDNEY, AUSTRALIA

1-800-538-8464

[www.usjetting.com](http://www.usjetting.com)

US JETTERS ARE SELLING IN: CANADA, MEXICO, DOMINICAN REPUBLIC, PANAMA, PERU, FRANCE,  
CYPRUS, RUSSIA, SAUDI ARABIA, QATAR, EGYPT, IRAQ, TAIWAN, CHINA, KOREA AND AUSTRALIA.

VIVAX

### 3 NEW vCam Digital Systems

Digital Command Module with Video digital recorder (60GB hard drive)  
 Crystal Clear "8" TFT LCD display  
 Three reel types, all work with Digital Command Module  
 - Mini reel "M" Type  
 - Standard reel "C" Type  
 - Large reel "P" Type  
 USB interface to transfer video  
 Full function keyboard and titler  
 Powered by internal rechargeable batteries, mains or 12v dc (car power)  
 Locatable Color Self Leveling Cameras  
 vCam Loc, a full function locator with color display



**Vivax Corp**

23-27 Bland Street Emerson, NJ 07630

TEL 201 265-5502

**WWW.Vivax.biz**

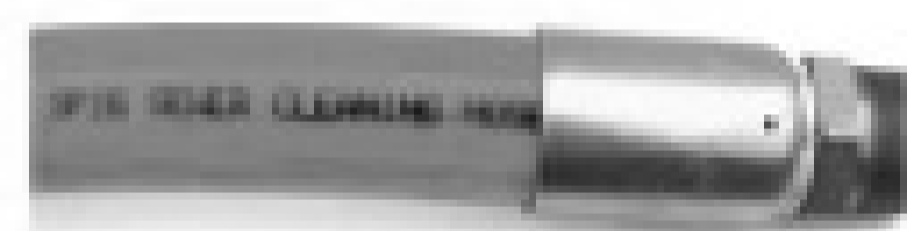

Jetter Hose



Hydraulic Swage  
Die Sets & Pusher  
\$925.00



High Pressure  
Valves  
3/4", 1", 1-1/4"  
2 Way Ball Valve  
3 Way Ball Valve

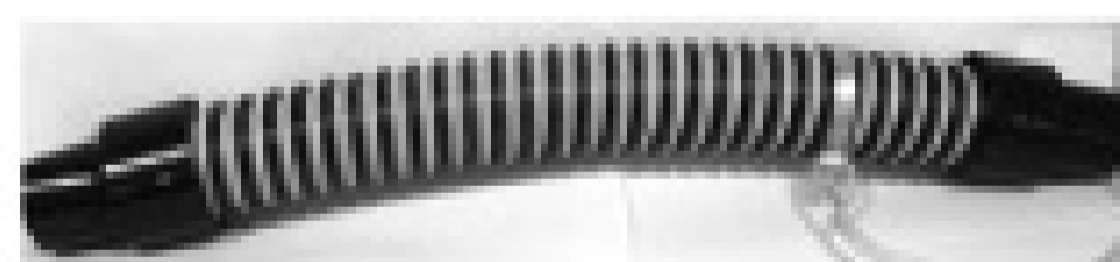

Tiger Tails

Chattanooga, Tennessee info@epasales.com

**EPA** ENVIRONMENTAL PRODUCTS & ACCESSORIES

866-448-5547 FAX 423-876-4389

**PRICES ONLINE!**

**www.epasales.com**

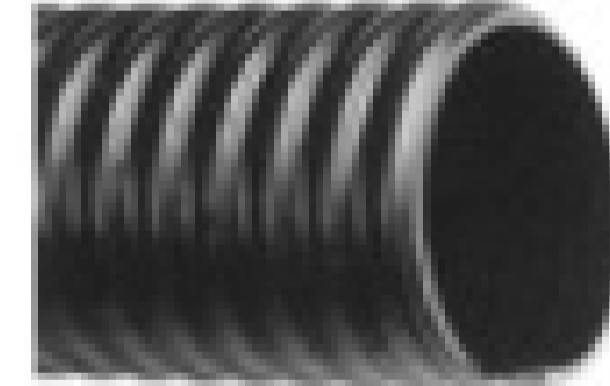

Suction Hose for  
Vacuum Trucks



Lever Valves  
Brass



Manhole Hook  
\$28.00



Hydrant Wrench  
\$16.95



Piston Valve  
Brass  
6" NPT \$210.00  
6" Flange \$225.00



Washdown Guns  
Adjustable Spray Patterns  
Cone to Stream Shape



Cam-Lock  
Duct Cap DC  
3" DC \$7.89  
4" DC \$11.00  
6" DC \$31.00



Cam-Lock  
Reducer  
3" to 2" \$20.00  
4" to 3" \$29.00  
6" to 4" \$55.00



Hose Reel  
Swivels  
3/4, 1", 1 1/2"

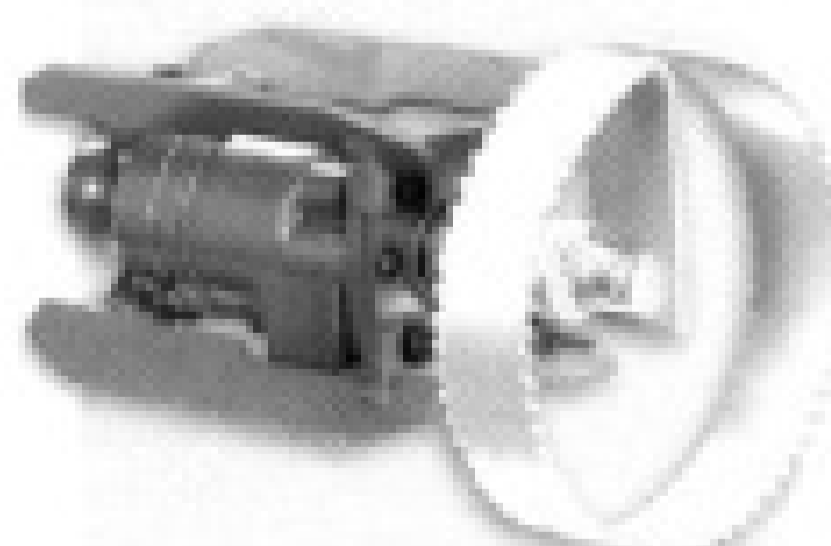

Root Cutters

**NEW!!!**

**BUY ONLINE!**

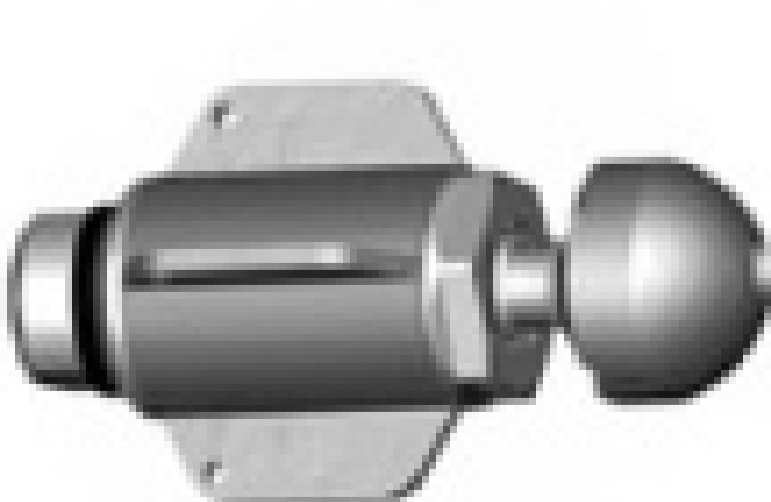

Warthog  
Rotating Nozzles



Chain Cutters



Catch Basin  
Flange \* Crown



Aluminum Tube



Aluminum Tube  
Aqua-Latch Couplers



Tube Handle  
Easy Clamp Onto  
Outside of Tube



Pipe Plugs



Hydrant Hose

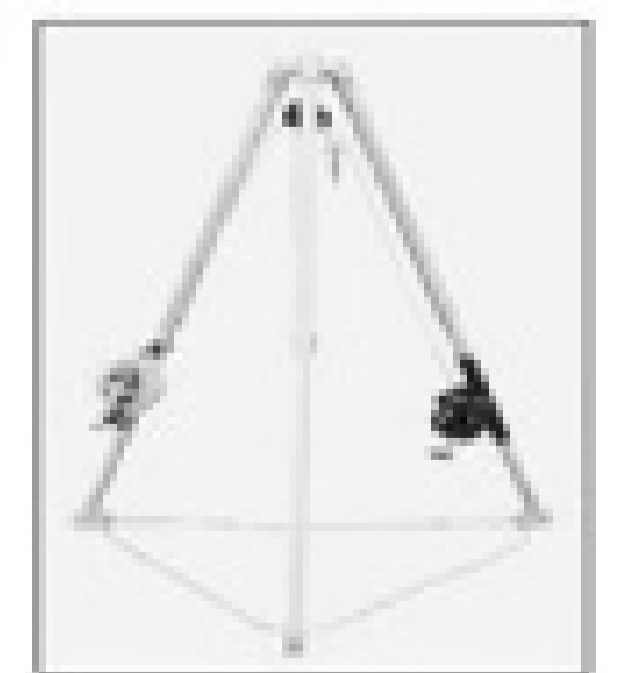

Fall Protection  
Tripod & Winch  
\$1,899.00

# HammerHead Pipe Bursting

*Replacing laterals? Which would you rather offer your customers?*



**This.**



**Or this?**



**Trust HammerHead to put you into high-profit lateral bursting quickly, easily and affordably.**

- ▶ Trenchless replacement of 2" – 6" pipe.
- ▶ Multiple systems available to suit your needs and conditions.
- ▶ Pulling unit runs off of any industry standard hydraulic power source.
- ▶ With just two lateral jobs per month, it can pay for itself in as few as five months.
- ▶ Time and money saving features like the patent pending Quick Grip burst head.
- ▶ HammerHead technicians provide free consultation services and on-site training.

**Call 800.331.6653 for a free project consultation and demonstration today!**

**MADE IN THE  
USA**

**HAMMER HEAD**  
*Mole*  
**TOUGH & TRUSTED**

**BORING • RAMMING BURSTING HDD ASSIST TRIHAWK TOOLING**



**PRECISION TANK & EQUIPMENT CO.**

[www.precisiontank.com](http://www.precisiontank.com) | 1.800.258.4197

CENTRAL ILLINOIS Manufacturer Celebrating over 40 years of steel and stainless steel tank equipment innovations. Tank sizes from 100 to 5000 gallons in stainless steel or steel.

Manufacturing plants in Virginia and Athens Illinois allowing rapid completion of your specialty equipment!

Over 40 years of excellence! PRECISION TANK & EQUIPMENT CO.

*Standard models or custom built units*

*Single or multiple compartments*



*Custom Fire Apparatus*



*Modular Vacuum Drop In Units*



*Vacuum Tankers*

*Street Flusher Tankers*

**1.800.258.4197**

# THE CABLE CENTER 1-800-257-7209

Now Available **The Ridgid SeeSnake® Micro** Inspection Camera

**\* 24 HOUR TURNAROUND \*  
MIDWEST'S LARGEST FACTORY  
AUTHORIZED REPAIR CENTER FOR  
GATORCAM, GEN-EYE  
& SEESNAKE**

Fully Adjustable LED Lighting

Waterproof Camera Head and Cable

Flexible 3' Cable

Twist and Lock Attachments

High Visibility 2.4" Color LCD

Comfort Grip

Protective Storage Case



4-AA Batteries Included

**CALL FOR SPECIAL PRICING ON ALL CAMERA KITS!**

**FREE DELIVERY ON ALL RIDGID CAMERA KITS**

RIDGID Durability Combined with Digital Technology

- Record videos digitally onto DVD and view on the system or any DVD player.
- High resolution LCD provides superior picture quality, even in sunlight.
- Lightweight at just 25 lbs., for increased portability.
- Water resistant touchpad makes it easy to navigate controls and keeps hands off DVD recorder.



**SeeSnake® LCD Monitor+DVD**

• THE CABLE CENTER • 8318 OLIVE BLVD. • ST. LOUIS, MO 63132 • 314-993-3099 •

# MAX-LIFE Manhole Tools



**M3PG-1**  
Three Prong  
Grabber.  
Great for  
Rocks and  
Roots.

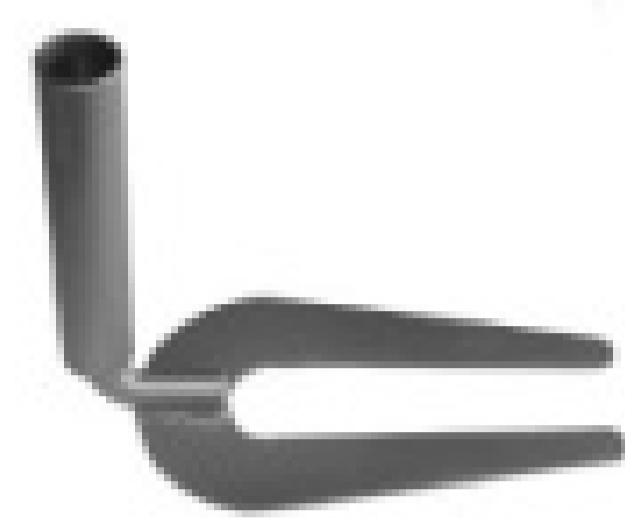

**MHG-1**  
Horse-Shoe  
Grabber.  
Great guiding  
hose in and out  
Of sewer lines.



**MGLC-1**  
Grease Log  
Chopper  
Sharp curved  
bladecuts thru  
heavy pieces.



**MDS-6-8-10**  
Debris Scoopers  
Heavy duty  
construction  
For 6", 8" and 10"  
Pipe sizes.



**MMH-1**  
Gaffing Hook w/20'  
nylon rope. Good for  
grabbing tool on end  
of rod at bottom of  
manhole so it can be  
changed.



**Catch-  
Basin  
Spoons**  
6'-18' feet  
2 or 3 piece  
Fiberglass  
poles.  
UPS-able !

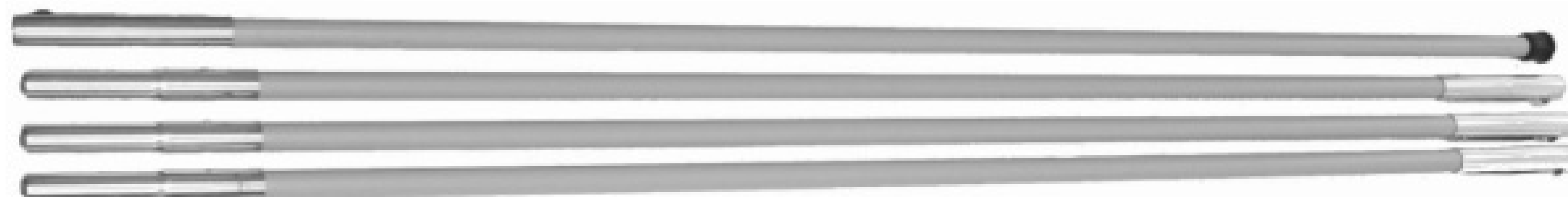

## MPAF-24 Quick Connect Fiberglass Poles

24' pole set used with above Tools and Debris Catchers. Each set includes 3 ea. 6' male x female and 1 x 6' end pole. These are Light, Strong durable poles with positive lock Aluminum quick couplings.

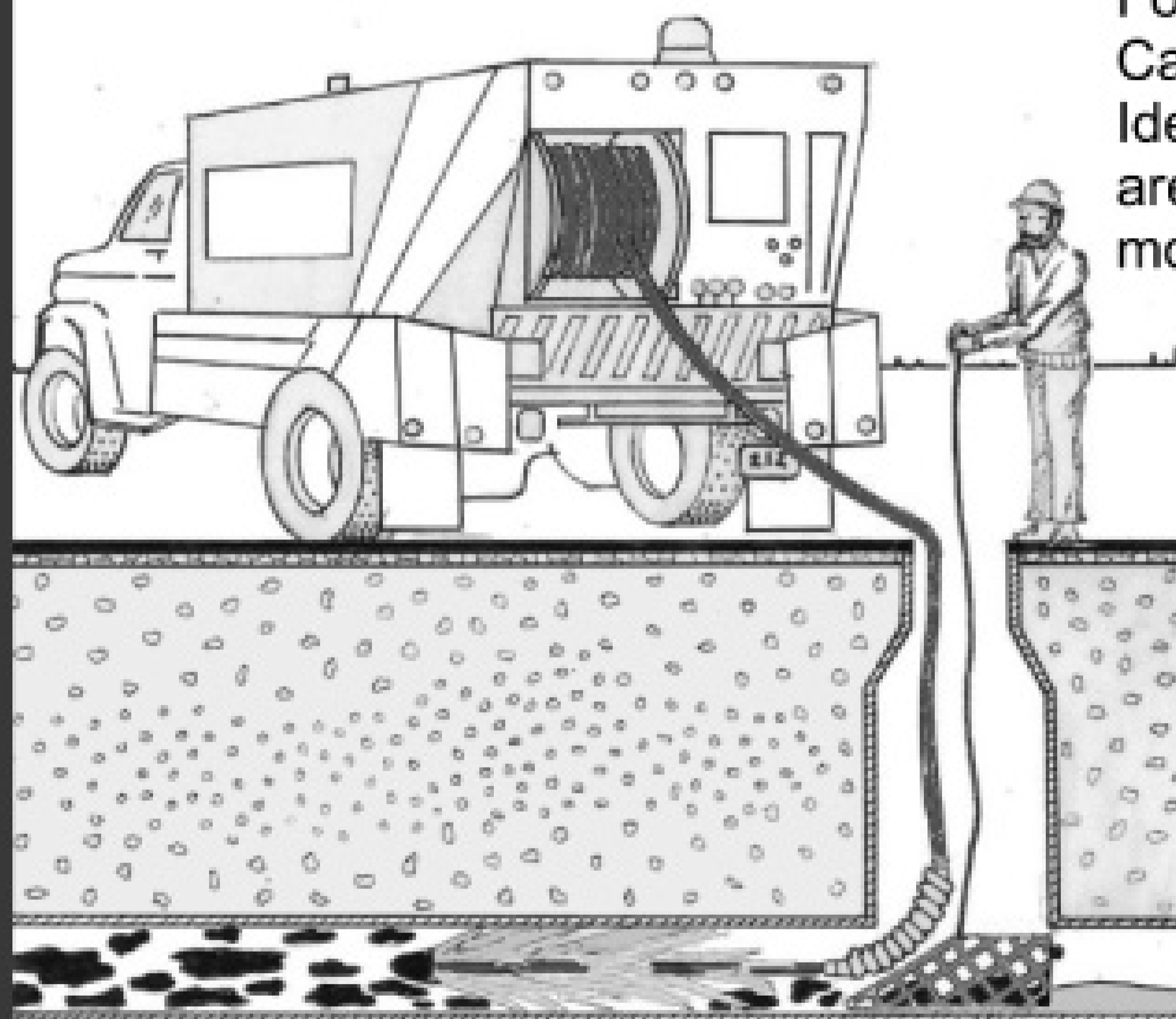

**MFT-714** 7' -14' telescopic fiberglass Pole Set. (Below) 14' Max. Length with Double Lock tightening system. Connects to Manhole tools and Debris Catchers.



## Debris Catchers

For 6" to 18" pipe. Use Debris Catchers with Jet instead of Combo. Ideal where small amounts of debris are expected. Standard **MDC-6**, 6" model Comes with 20' of Poly Rope



Specify **MDC-6W**, 6" pipe size to use with fiberglass poles (see right) in any length for positive action of positioning, raising and lowering in manholes. For 6" to 18" pipe. Special larger sizes available.

Debris  
Catcher



Grit  
Catcher

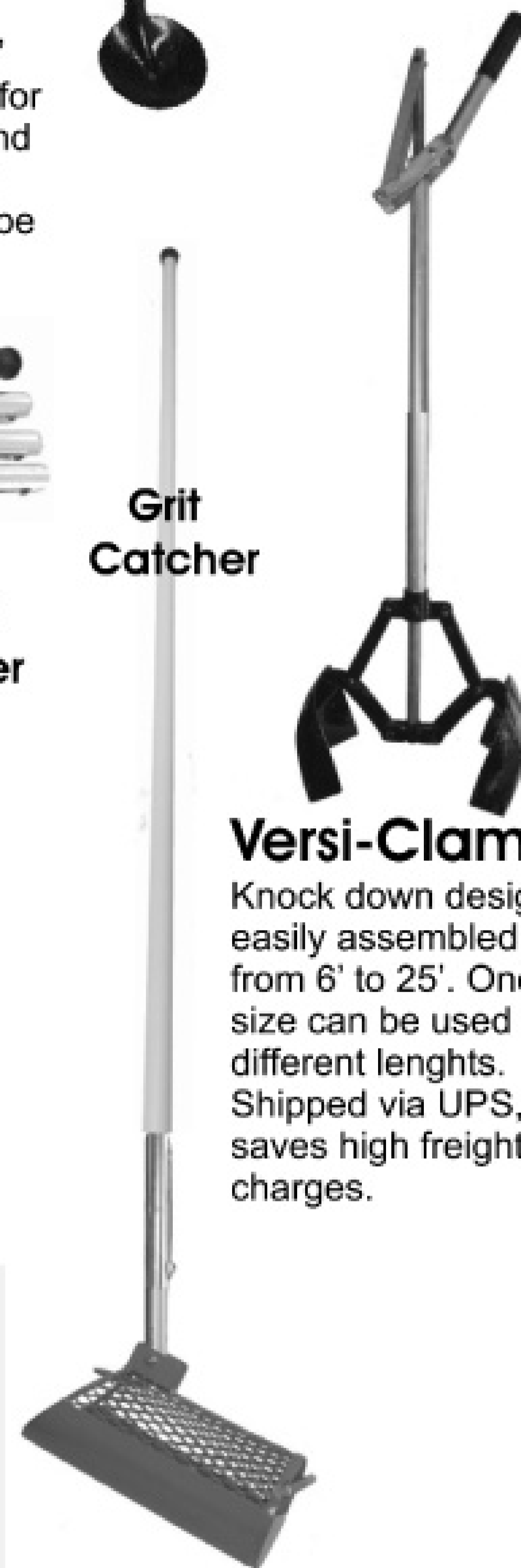

## Versi-Clam.

Knock down design, easily assembled from 6' to 25'. One size can be used in different lengths. Shipped via UPS, saves high freight charges.

## Grit Catchers

**MDC-6CW** (above) are similar but have half moon bottom around sides and back to stop finer grit and black sand from flowing thru. Fills with material faster.

## MAX-LIFE MANUFACTURING CORP.

COMPLETE LINE OF SEWER RODDING TOOLS AND EQUIPMENT 888-873-6295 11580 Seaboard Circle, Stanton, California 90680 / FAX: (714) 714-897-2810 www.flexmax.com dhp@flexmax.com

# More Than a Bookkeeper

A quality accountant can provide analytical services and sound advice on a variety of issues and decisions that drive success and growth

By Mark E. Battersby

**A**ccounting is a foreign language to the owners of many service businesses. An accountant is far more than someone who prepares income tax returns. Understanding what an accountant does — and using those services — can mean the difference between a troubled business and a successful one.

Many owners think accounting and bookkeeping are the same. They are not. Bookkeeping is chiefly the clerical phase of accounting. A bookkeeper primarily records the business' financial transactions.

Accounting is much broader. Accountants develop systems to classify and summarize transactions and interpret financial statements. They are — or should be — decision makers.

## A business partner

Accountants are far more than tax preparers or "bean counters." A good accountant can be a business owner's financial partner for life — with intimate knowledge of everything from how to finance the next equipment purchase to how to pay for a child's college education.

A general accounting practice usually covers four basic areas: business advisory services, accounting and record keeping, taxes and auditing. More and more accountants are also moving into personal financial planning, a natural extension of their familiarity with their clients' financial affairs.

The four basic disciplines often overlap. For instance, an accountant helping prepare financial statements required for a loan might cross the line from auditing into business advisory services by showing how certain estimates could be recalculated to get a more favorable review. Or, after preparing midyear financial statements, the accountant might suggest how year-to-date figures will affect year-end tax liability.

An accountant can be hired to set up a bookkeeping system for a new or growing business, to help evaluate a particularly complex business transaction, to prepare annual tax returns, or to provide accounting services on an on-going basis. But, how can you find a good, affordable accounting professional?

## Many choices

According to the Bureau of Labor Statistics, there were 1.2 million accountants and auditors employed in 2004. Some 134,000 CPAs owned their businesses or worked for firms serving mostly small or mid-sized businesses.

So, finding a professional to help your drain cleaning business grow should not be difficult. The key is to choose the right accountant. The first step is to take an inventory of what you and your business need in service and advice and how much you can afford to pay. You need to determine up front which tasks you can handle and which to delegate to a professional.

It's essential to shop around. Many accountants offer free first meetings to discuss expectations, services needed, and the amount and kind of work they will be expected to do. The best way to start is to get referrals from your attorney, your banker, or a business colleague. For more possibilities, every state has a Society of Public Accountants.

In choosing an accountant, remember that bigger isn't always better. A large accounting firm

**Accountants are far more than tax preparers or "bean counters." A good accountant can be a business owner's financial partner for life.**

may have impressive credentials, but its fees are likely to be high, and a small business is likely to be served by a less experienced junior partner. This is not a bad thing, so long as the charges accurately reflect that junior member's lower billing fees.

## Things to consider

When interviewing potential accountants, consider services performed, personality and fees. Virtually all accounting firms offer tax and auditing services. But what about bookkeeping? Management consulting? Pension fund accounting? Estate planning? Will the accountant help you install and set up bookkeeping software?

Other services include analyzing transactions for business loans and financing; preparing, auditing, reviewing and compiling financial statements; managing investments; and even representing the business or its owner before tax authorities in case of an audit.

In addition to services, make certain the accounting firm has experience with businesses of a similar size and, if at all possible, with your industry. Someone already familiar with the financial issues facing small businesses will not have to waste time and money getting up to speed.

Another important question: Is the accountant's style compatible or complementary with yours? You want an account whose personality makes you comfortable and whose outlook generally fits your own.

On the other hand, it can be healthy to have an accountant who takes a different approach. For example, if you are extremely conservative, a more aggressive accountant may be able to help you see things in new ways. As part of the interview, ask whether the person you are speaking with will actually handle your business.

Always ask about fees up front. While you should not make your decision solely on price, the hourly rate is a consideration. Accounting firms charge by the hour at rates ranging from as low as \$75 per hour to as much as \$300 or \$400. Some accountants work on a retainer, providing certain regular services against a flat monthly fee.

After determining what accounting services you need and what options will be the most cost-effective, get quotes from different accountants. Also, try to get an estimate of total annual charges based on the services you have discussed. Don't forget references — particularly from clients in the same industry.

## Nurturing relationships

After you choose an accountant, make sure the terms of the agreement are spelled out in an engagement letter, especially details about the returns and statements to be provided and the fees charged. This ensures you and the accountant have the same expectations and helps prevent misunderstandings.

The accounting relationship is much like a partnership in which each party is expected to do his or her share. For example, at tax time, don't hand the accountant a shoebox full of jumbled receipts. Record details of all checks in your check register. Likewise, identify sources of income on your bank deposit slips. The better you maintain records — ideally on computer software — the less time your accountant has to spend on your business, and the lower your fees will be.

It is a good idea to meet with your accountant every month. Review financial statements and go over any problem areas so you know exactly where your money is going. This is when your accountant should go beyond "number crunching" to suggest alternative ways of cutting costs. The accountant also can act as a sounding board for any ideas or questions you have about your finances.

Obviously, not every business needs or can afford the specialized knowledge and skills of an accountant. But it is wise to know what services accountants can offer in case your business should need them in the future. Now is a good time to find an accountant and discuss how accounting services can help your business grow. ■

# Stop Infiltration and Inflow

with CUES Custom TV/Cutter/Grout Systems -  
Truck Mounted and Portable

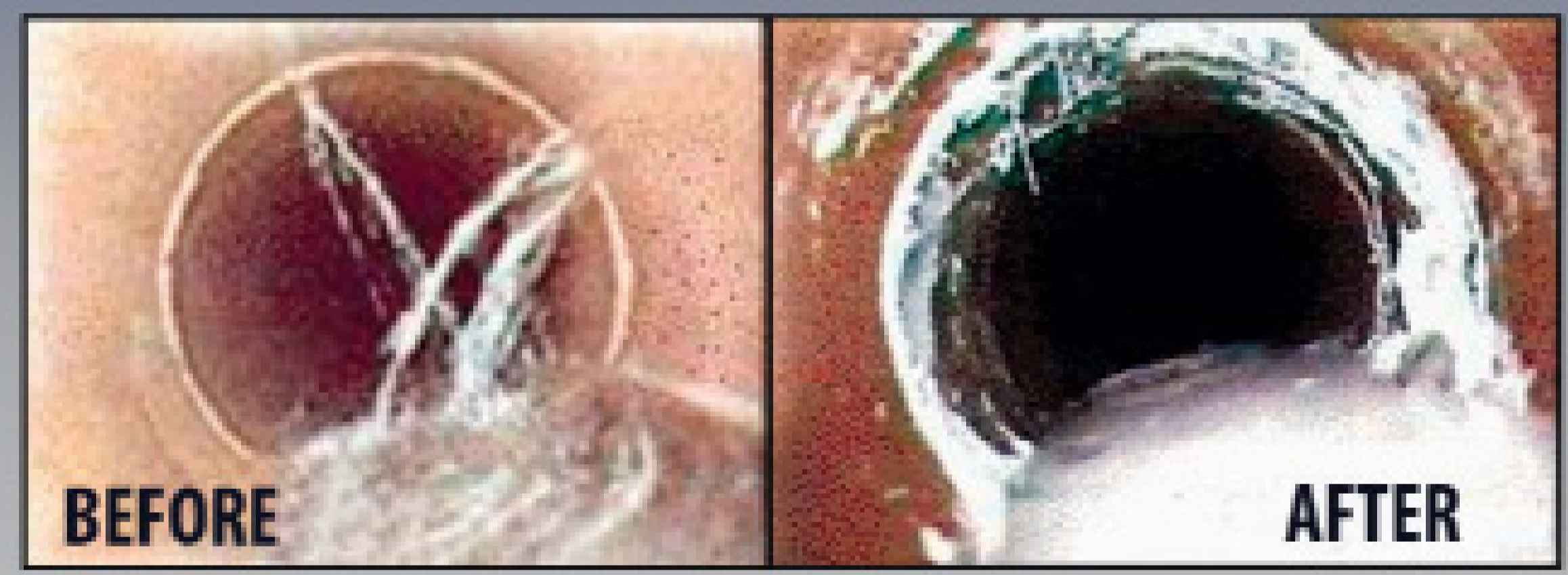
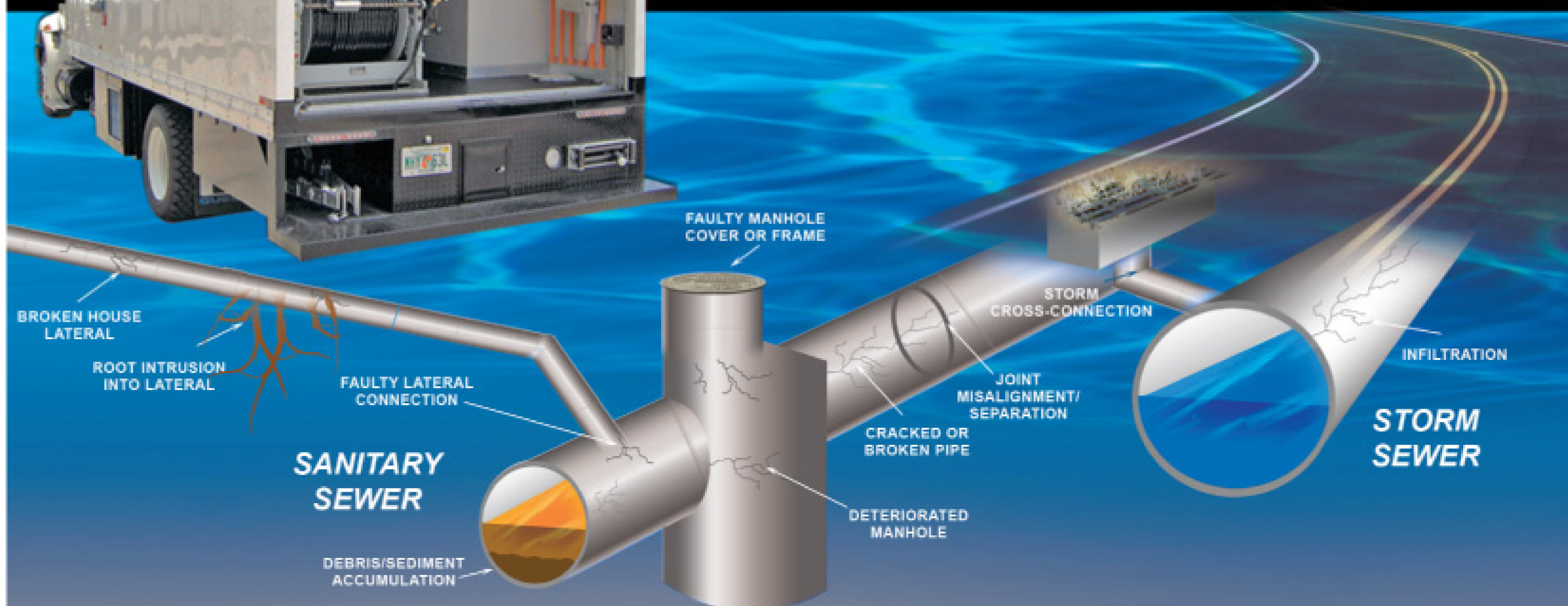

## TV/Grout/Lateral Reinstatement Trucks

CUES offers TV/Grout/Lateral Reinstatement Trucks as an all-in-one production unit that can complete TV inspection of mainlines, laterals (optional), joint sealing of mainlines or laterals, and lateral reinstatement (cutting). Pipe inspection operations and the resultant rehabilitation action are facilitated by one integrated system!

## Reinstatement Cutters

CUES offers the Kangaroo & Giant Kangaroo Lateral Reinstatement Cutters for your relining and spot repair requirements! The cutters can function in a range of 6" through 30" pipe and are effective with all types of liners.

## LAMP (Lateral & Mainline Probe)

The Lateral and Mainline Probe is a robust self-propelled lateral and mainline inspection system operable in mainlines ranging from 6" to 30" and laterals ranging from 2" to 8". The lateral camera can be launched from the upstream or downstream direction, making entry into the Wye joints an easy process.

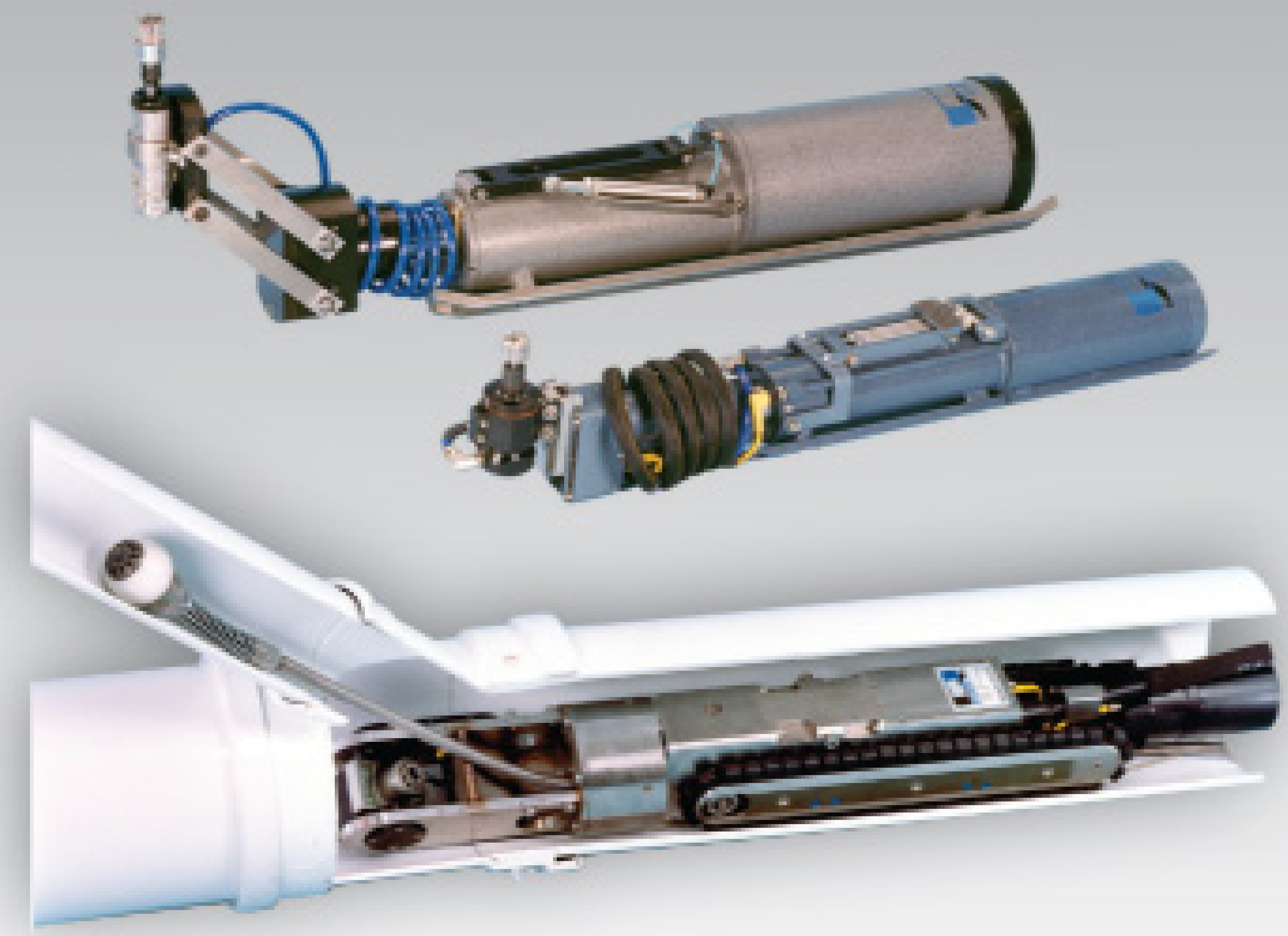

"The Standard of the Industry"



[www.cuesinc.com](http://www.cuesinc.com)

800.327.7791

[salesinfo@cuesinc.com](mailto:salesinfo@cuesinc.com)



# Super Products

Worldwide Vacuum Technology - Since 1972

- › Innovative Features
- › Easy to Operate, Clean & Maintain
- › Heavy Duty Capacity
- › High Value Performance
- › Stock or Custom Designed for Your Needs



**Super Products**

17000 W. Cleveland Ave.  
 New Berlin, WI 53151  
 Phone: 262.784.7100  
 Fax: 262.784.9561  
 E-mail: sales@superproductscorp.com

**Camel®**  
 Catch Basin & Sewer Cleaner



**Mud Dog®**  
 HydroExcavator



**High Quality Parts**  
 Nozzles & Accessories

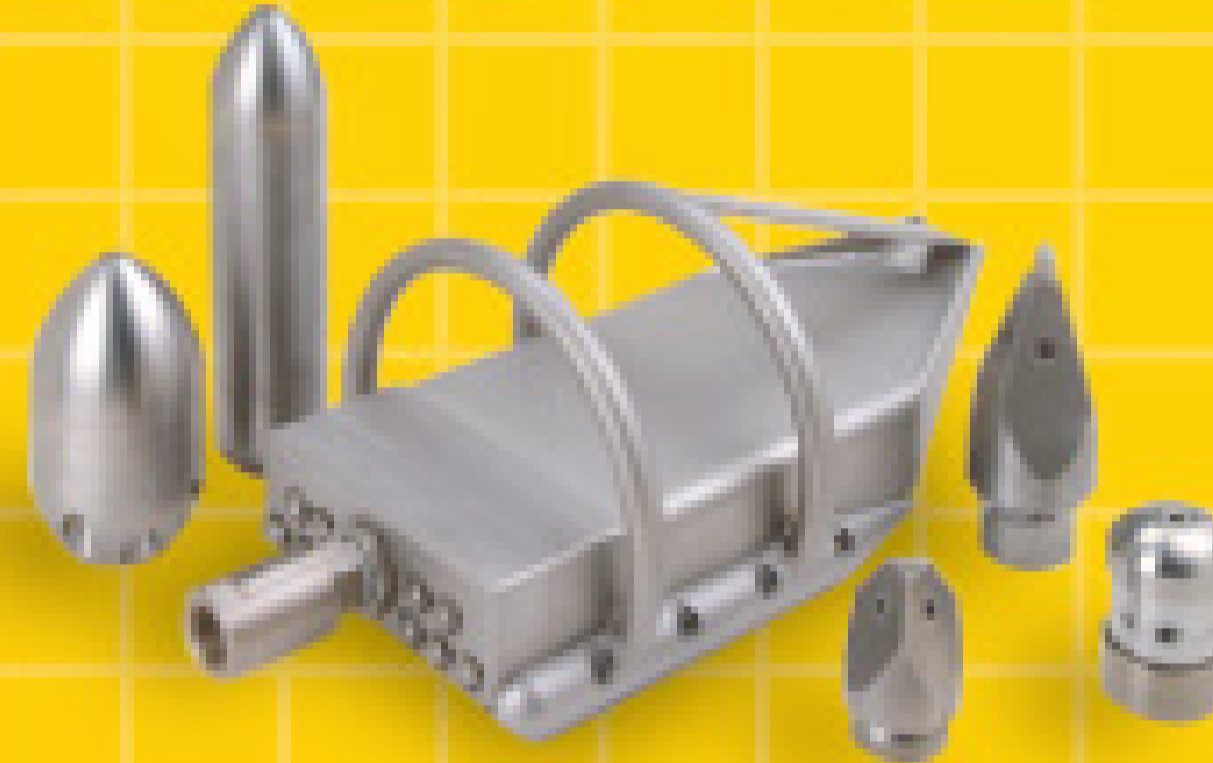

**Supersucker®**  
 Industrial Vacuum



[www.superproductscorp.com](http://www.superproductscorp.com)

800.837.9711

XPRESS YOURSELF!

# insight | VISION



**INTRODUCING**  
 The Xpress  
 Series from  
 Insight VISION.  
 Featuring the  
 clearest and  
 brightest  
 Clearview  
 Cameras.



600 Dekora Woods Blvd. Saukville, WI 53080 800.488.8177 262.268.9330

[www.insightvisioncameras.com](http://www.insightvisioncameras.com)



**insight | VISION**  
 An Alliance Technology Company





NLB 325D

# NLB 325 Series: everything you like about the NLB 225, at 400 hp



125D: 115-145 hp



225D: 200-300 hp



605D: 475-600 hp

The new NLB 325 Series convertible pump units have a lot in common with our popular 225 Series — including the parts. That makes maintenance and inventory even easier, while letting you do jobs that require up to 400 hp.

With the 325 Series, NLB again meets customer needs, bringing convertible water jet technology and quick-change fluid ends to quintuplex pumps. We now offer 22 convertible models, the most in the industry, with an unbeatable range of pressures, flows and horsepower.

See for yourself how the NLB 325 can boost your productivity. Call 1-877-NLB-7988 today for a free demo, or visit [www.nlbcorp.com](http://www.nlbcorp.com).

### NLB 325 Series: Available Configurations

Model	GPM	PSI
<b>Model 405 (400 HP)</b>		
24405D	25	24,000
20405D	30	20,000
15405D	40	15,000
12405D	50	12,000
10405D	60	10,000
8405D	74	8,000
<b>Model 365 (365 HP)</b>		
24365D	22	24,000
20365D	27	20,000
15365D	34	15,000
12365D	42	12,000
10365D	51	10,000
8365D	64	8,000

**NLB. The Contractor's Choice.**



29830 Beck Road, Wixom, MI 48393  
 MI: (248) 624-5555, TX: (281) 471-7761, NJ: (856) 423-2211  
 LA: (225) 622-1666, CA: (562) 490-3277  
 e-mail: [nlbmkgtg@nlbusa.com](mailto:nlbmkgtg@nlbusa.com)

# Dyna-Vac Equipment

VACUUM PUMPING &  
SEWER CLEANING EQUIPMENT

## Jet-N-Vac

Experience the Compact Power, Enduring Reliability and Piece of Mind Economy of the Jet-N-Vac Systems. Practical Features make these units Simple, Safe and Reliable while delivering the power for the toughest cleaning jobs



Proudly Built and Assembled in our Factory in Central NY



## Dyna-Jet

Dyna-Jet Trailer Jettors  
Tubular Steel Construction,  
Quality Components and our  
exclusive Zinc Primers to  
prevent corrosion make these  
units the obvious choice for  
all your jetting needs.



DJ18-4000

888-298-8668 \* 315-865-8084 \* [www.dynavacequipment.com](http://www.dynavacequipment.com)



If this was your home and  
you needed your sewer lateral replaced...

# Would you dig?

Since we are a stocking distributor  
we can offer you special pricing!

**GIVE US A CHANCE TO QUOTE YOU ON  
YOUR NEXT REHAB PRODUCT PURCHASE!**



## PRIMELINE PRODUCTS, INC.

"Your Prime Source for Solutions, Products & Training"

MAXLINER®

### PRIMELINER® / MaxLiner® Lateral Lining

PRIMELINER® uses an engineered composite made of a felt tube and an epoxy ambient cure resin to invert a liner into the lateral from the property line or cleanout to the connection with the sewer line, forming a "pipe within a pipe" to effectively repair broken pipe, leaking joints and other infiltrating defects in the lateral pipe.



Manhole/Wetwell  
Rehabilitation  
Products



de neef

XCALIBUR

- > Fast Setting Plug Materials
- > Spray Mortars
- > Epoxy Coatings
- > Concrete Restoration Products

- > Waterstop Materials
- > Urethane Grouts
- > Acrylate Grouts
- > Grout Pumps
- > Expansion Joint Materials



We are now  
a Pearpoint  
Distributor!

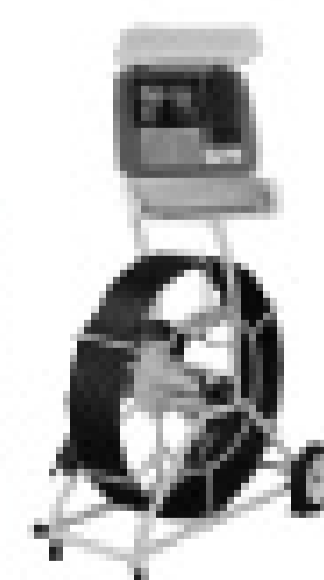

Plugs, Smoke Testing,  
Joint Testing Equipment!!



**We are Committed to Earn Your Business!! Call Us Today!!**

Toll Free: (877) 409-7888 • International: (407) 772-8131 • Visit Our Website: [www.primelineproducts.com](http://www.primelineproducts.com)

Lateral Lining ~ Manhole Rehabilitation ~ Chemical Grouts ~ Internal Seals ~ Concrete Restoration Products ~ Epoxy Materials ~ Testing Equipment

The Emerson logo is a trademark and service mark of Emerson Electric Co. © 2008, RIDGID, Inc.



# GOES ANYWHERE YOU GO.

## The RIDGID® K-400 — The Most Portable Drain Cleaner Of Its Kind.

This new, heavy-duty drain cleaner for 1-1/2" to 4" lines is designed specifically for easy maneuverability to, from and on the job site. Its innovative features include a wheeled cart for portability; built-in, telescoping handle for easier transport and storage; and an integrated stair climber design for use in multi-story buildings. Get the K-400 and get going...anywhere you want.

Learn more and schedule demonstrations: 800.769.7743 or [www.RIDGID.com](http://www.RIDGID.com).

**We Build Reputations™**

**RIDGID®**

**EMERSON**  
Professional Tools

DIAGNOSTICS

PRESSING

PIPE & TUBE TOOLS

DRAIN MAINTENANCE

POWER TOOLS

# WARTHOG™ Solutions

Visit [www.sewernozzles.com](http://www.sewernozzles.com) for :

For everyone from trailer jettors to pumper trucks & municipalities

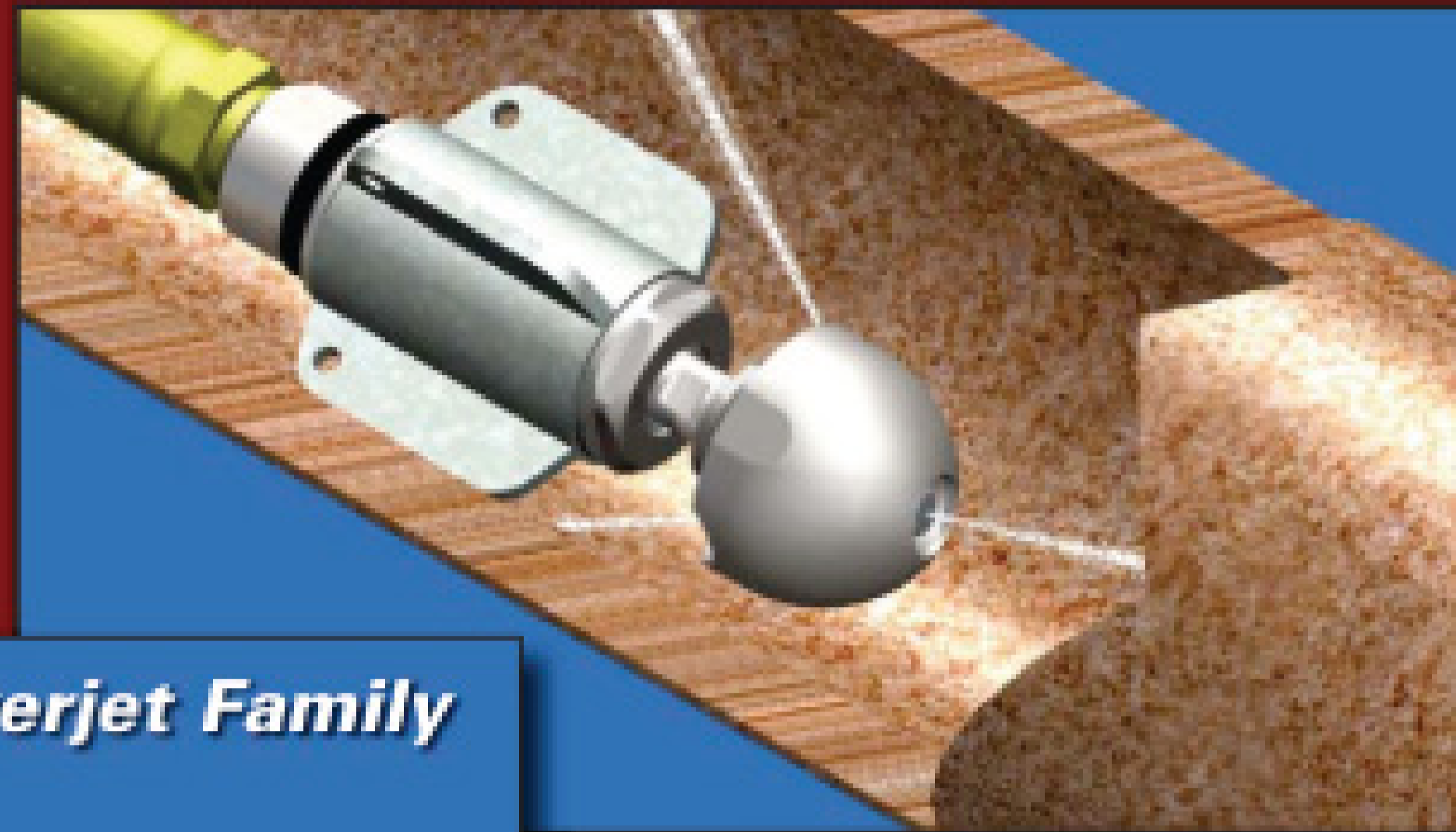

## The WARTHOG Sewerjet Family



6"-36"  
Pipes

6"-36"  
Pipes

6"-18"  
Pipes

4"-8"  
Pipes

3"-6"  
Pipes

- **Video Gallery**  
See all the tools in action!
- **Reference Center**  
Find answers to your problems
- **Nozzle Selection Guide**  
Easy to use chart matches your pump to Warthog tools
- **Find Distributors Worldwide**  
Local suppliers who can provide the best service



P. (970) 259-2869 F. (970) -259-2868



## WE'VE GOT DRESSER ROOTS BLOWERS AND A LOT MORE

The Dresser Roots blowers are the finest truck mounted units available today. And, as a factory authorized sales and service center we're here to provide the best support for all your blower applications.

We're also here to help with your vacuum equipment repairs, rebuilding, and replacements that also includes our special blower exchange program.

Just give us a call.

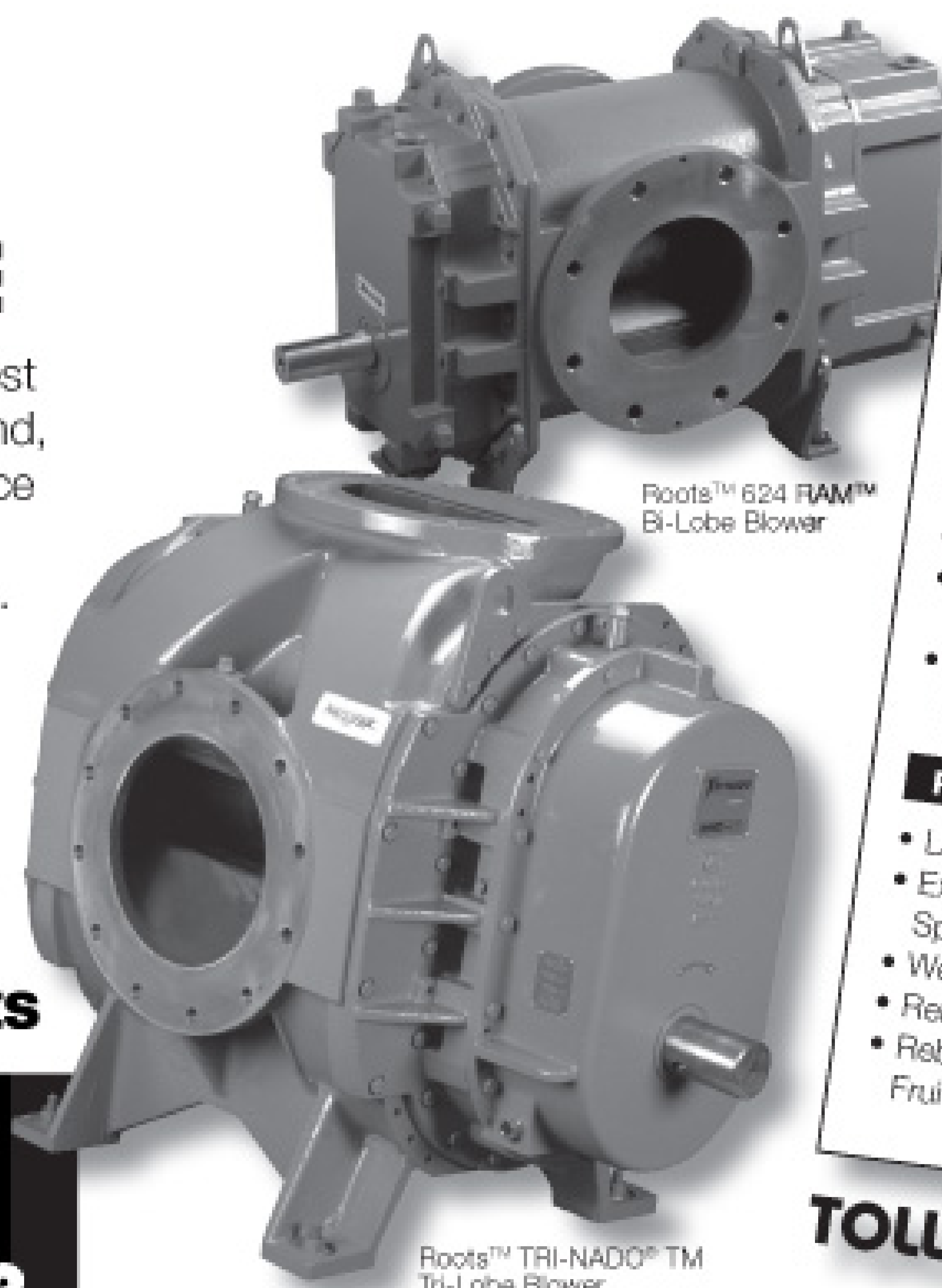

Roots™ 624 RAM™ Bi-Lobe Blower

Roots™ TRI-NADO™ TM Tri-Lobe Blower

### VACUUM PUMPS, TRUCKS & ACCESSORIES

- Aquatech** • Sewer trucks & equipment
- Conde** • Toilet truck vacuum pumps
- Hi Vac** • Industrial vacuum systems
- Metaltecnica** • Valves & accessories
- O'Brien** • Sewer cleaning jettors
- Presvac** • Septic & sewer trucks
- Roots** • Bi-lobe & tri-lobe vacuum blowers
- Stoddard** • Intake filters & discharge silencers
- World-Tech** • Sewer cleaning nozzles & valves

### COMPLETE FABRICATION & MACHINE SHOP

- 24 Hour service
- Custom built blower and pump vacuum/pressure packages: electric, gas, or diesel
- Custom parts fabricated or reconditioned including bearings, shafts & sleeves

### REBUILD SPECIALISTS

- Largest blower repair center in the Universe.
- Experts in rebuilding blowers: Roots, Sutorbilt, Spencer, and Hibon
- We rebuild all vacuum pump makes and models
- Rehab sewer cleaning trucks and equipment
- Rebuild kits in stock for Schult, Wittig, Moro, Jurap, Fruitland, and Challenger

**TOLL FREE: (800) 359-PUMP**

Orlando, FL: 800-359-7867 • [WWW.PATSPUMP.COM](http://WWW.PATSPUMP.COM) • Atlanta, GA: 800-851-7987

# TOOLS AND TECHNIQUES TO HELP YOU WIN JOBS AND EARN MORE PROFIT.

## Cleaner

FOR RESIDENTIAL, MUNICIPAL AND  
INDUSTRIAL CLEANING CONTRACTORS

WWW.CLEANER.COM

1 Year (12 issues) ... **\$15.50**

2 Years (24 issues) ... **\$25**

3 Years (36 issues) ... **\$35**

(U.S. rates only. Call for intl. rates)

Start my subscription to *Cleaner*<sup>®</sup> magazine.

Signature (required) \_\_\_\_\_ Date \_\_\_\_\_

Attention \_\_\_\_\_

Company Name \_\_\_\_\_

Mailing Address \_\_\_\_\_

City \_\_\_\_\_ State \_\_\_\_\_ Zip \_\_\_\_\_

Phone \_\_\_\_\_ Fax \_\_\_\_\_

E-Mail \_\_\_\_\_

### METHOD OF PAYMENT (please check one):

Check enclosed (payable to COLE Publishing Inc.)

Charge to VISA \_\_\_\_\_ MasterCard \_\_\_\_\_ Discover \_\_\_\_\_

Card # \_\_\_\_\_ V-Code \_\_\_\_\_

Cardholder Name \_\_\_\_\_ Exp. Date \_\_\_\_\_

What is your company's primary function? \_\_\_\_\_

What else does your company do? (circle letters below):

- |  |  |
|--|--|
| A TV/Video Inspection                      | M Manufacturer of _____                    |
| B Pipeline Rehabilitation/Sewer Repair     | N Septic System Design                     |
| C Drain/Sewer Cleaning (Rooting, Jetting)  | P Plumbing/Heating/Cooling                 |
| D Dealer/Distributor of _____              | Q Excavation/Grading                       |
| E Grease Pumping/Disposal/Treatment        | R Refuse (Solid Waste) Hauler              |
| F Septage or Sludge Disposal/Treatment     | S Septic Tank Service-Pumping/Maintenance  |
| G Government/Municipality/POTW             | T Portable Toilet Rentals                  |
| H Hazardous/Industrial Liquid Waste Hauler | V Industrial Plant Service Vacuum/Cleaning |
| I Septic System Installation/Repair        | W High Pressure Waterblasting              |
| J Non-Hazardous Liquid Waste Hauler        | Y Hydroexcavation                          |
| K Directional Drilling/Boring              | Z Equipment Rental Center                  |
| L Consulting                               | Other _____                                |

**Fax** this form (with payment option selected) to 715-546-3786

**Mail** this form (with payment option selected) to  
COLE Publishing, P.O. Box 220, Three Lakes, WI 54562

**Phone** 800-257-7222 **Online** at [www.cleaner.com](http://www.cleaner.com)

C0708

# Someone Has to Do It

**A-K Underground has found and stuck to a niche in handling difficult, messy cleaning jobs that other contractors walk away from**

By Mary Shafer

Al Kulig takes a straightforward approach to business. He brings the savvy of a sales position to the operational challenges of tough cleaning jobs.

Against conventional wisdom in an industry that encourages diversification, Kulig has found a profitable niche in truly difficult, sometimes disgusting jobs no one else wants.

A-K Underground, the business he owns with his wife, Karen, concentrates on clearing hopelessly clogged sewers, weirs, box culverts and other utilities. His strategy is to stay small and reap big rewards.

#### The accidental cleaner

“Not every job is complex,” says Kulig. “We might get called out to

clean the drain from a retention pond that isn’t draining, or from a contractor whose equipment knocked rocks down into a manhole and blocked it off.” Small, often simple jobs like these opened the door for A-K Underground to enter the cleaning business.

Kulig used to sell sewer cleaners and related equipment. In 1990, he sold an old, Vactor combination truck

to a friend. Five years later, the friend called, wanting to sell the truck back. “He also sold me \$100,000 worth of business, so I left my sales job and took it over. I got a VacAll street sweeper and modified it with a Vactor boom to clean out catch basins.”

This enabled Kulig to tackle more challenging jobs, and he began to get calls for small projects that didn’t interest larger competitors. “A lot of bigger contractors with the powerful equipment stay away from

the small jobs — the ones that take two hours up to one day, rather than two to three months,” Kulig says.

“We thrive on that. We didn’t want to go after the hyper-competitive government contracts, so we positioned ourselves to do smaller jobs well, and do them right. We found a lot of people complaining about jobs left half-done. We’ve never had a callback, unless it’s for additional work. I believe in no callbacks. We don’t leave until the

## PROFILE

### A-K UNDERGROUND TINLEY PARK, ILL.

OWNERS: Al and Karen Kulig  
FOUNDED: 1995  
SERVICE AREA: Metro Chicago  
EMPLOYEES: 6  
SPECIALTIES: Challenging drain, pipe and culvert cleaning jobs



Larry Jeffries (right) hydrojets a sewer line while Chuck Cushing checks on progress. The truck is parked several feet from the structure to allow room for viewing while jetting and vacuuming. (Photos by Dave Kenik)





Larry Jeffries operates the jetter on a combination unit as Chuck Cushing vacuums debris.

**“We didn’t want to go after the hyper-competitive government contracts, so we positioned ourselves to do smaller jobs well, and do them right. We found a lot of people complaining about jobs left half-done. We’ve never had a callback, unless it’s for additional work.”**

**Al Kulig**

job is done. So I don’t schedule other jobs until the one we’re working on is complete.”

#### **Long work days**

It’s a tight juggling act that keeps Kulig hopping about 12 hours a day. “We have two or three crews going, so things stay busy,” he says. “I call ahead of time to schedule, so the customer knows when we’re coming. That keeps everybody happy. No one’s sitting around with a crew full of union workers, waiting for a truck to show. You do that once,

you’ll never get another call.”

A-K doesn’t do residential work. Thirty to 40 percent of its business is commercial and government contracts, and the rest consists of service to developers and apartment complexes.

Kulig’s sales background helps him win business as a contractor. “In sales, you’re always trying to please the customers and get in their heads to see what they need and want,” he says. “Then you try to perform when and where they want, within their budget. I transfer those

## **STAYING SAFE**

Al Kulig demands constant attention to safety from his field crews. They wear hardhats and reflective vests on almost every job. “Sometimes it’s hard to get the guys to use safety glasses because they get dirty so quickly, but we stay after them,” he says. “It’s important.” Kulig himself was the cause of one safety addition.

“When lift stations are particularly deep, they’re so far from the vacuum tube that it can’t reach all the way, so you have to put a guy down there with confined-space entry equipment to shovel debris into the hose,” he says. “That can be dangerous. You really have to work with care, not to get arms or hands too close to the hose.

“We now use a vacuum brake when we’re a long distance from the hose, since one job where I got my arm caught in it. I was trying to shovel some debris into the vacuum tube, and a piece of garbage got caught in front of it. I went to grab it away from the tube, and my arm got sucked into it.

“It took almost two minutes to pull it away, and my arm was blue for two weeks. It was painful and made me nervous, since I’d had open heart surgery before that, and wasn’t supposed to stress my body.”

Blue arm and all, Kulig was soon back to work.



Owner Al Kulig (left) and operator Chuck Cushing discuss progress on an obstructed sewer line.

skills to what we do now.

“I’ve found customers appreciate a problem-solver. I try to come up with a solution, and then I keep that customer. Not only do you need to listen, but you’ve really got to hear what the customer’s not necessarily telling you. What’s the problem, short-term and long-term? How do you fill that void?”

To make sure he finds an answer, Kulig strategizes every job. “I plan with scratch pad and pencil,” he says. “I know what I have for capabilities and equipment, so I listen for what the problem is. I might go to look at the job in advance. I know what needs to be done, but not how long it’ll take. We bid those jobs on a time-and-materials basis.

#### **Ready and willing**

“You have to make sure you bring all the equipment and staff you might need. You don’t want to have your customer waiting for you to

finish the job so they can proceed with their project, and then have to admit you don’t have the right equipment.

“There may just be a dirty pipe or catch basin, but even on these apparently simple cleaning jobs, you might run into something unexpected. We keep three different nozzles on each truck to make sure we’re ready for whatever comes up.

“Like yesterday, a road had sunk in and we needed to televise the pipes underneath. It looked like liability all over the place. We had to put danger signs and cones everywhere just to be able to clean it, but we got it done and no one got hurt. If you take care of that kind of thing, you’ve got a friend, and that’s better than just a customer.”

Sometimes, pleasing a customer is a matter of being creative. “We’ve cleaned elevator shafts, and the hydraulic cylinders sometimes go bad and the hole would fill up with



An A-K Underground technician monitors a video inspection. (Photo courtesy of A-K Underground)

**“I’ve found customers appreciate a problem-solver. I try to come up with a solution, and then I keep that customer. Not only do you need to listen, but you’ve really got to hear what the customer’s not necessarily telling you.”**

**Al Kulig**

water and sand,” Kulig says. “So the workmen could get at those, we had to go down 30 or 40 feet and vacuum that out. I had put a hydroexcavating pump on one truck, so I could jet a line and excavate with the same vehicle. So we used that.

A-K’s equipment includes an Aquatech combination unit with a Robuschi vacuum powered by an FMC pump and jet rodder for large circumference cleaning; a Clean Earth (VacAll) combination truck with a Dresser Roots blower; and a Guzzler vacuum truck converted into a combination unit.

#### Formula for success

Equipment is only half of what it takes to do the job, and Kulig says the other half is in good shape at A-K Underground. “For some reason, I’ve found good help,” he says. “I call the union because those guys have their CDLs, have some apprenticeship in, and have some idea of what’s involved in the work. In Chicago, the money’s good, plus they get a pension and 100 percent

healthcare coverage. That’s a job worth showing up for. I believe it’s the money that attracts the kind of guys you want.”

Kulig can spot winning candidates quickly. “You can tell when you interview, or after a few days on the job, whether a guy’s into it or not,” he says. “Generally speaking, the guy should be over 30 and married or with a family, because he’s stable and wants to work. If he doesn’t work, he’s gone. I tried some 20-year-olds, but they weren’t ready to work. Drugs, alcohol and tardiness were real problems. If they’re like that, they’re not here. It’s too dangerous, and failures cost money.”

Dedicated crews are necessary to handle the tough assignments A-K Underground takes on. On one job, a contractor called the company to clear a 12- by 9- by 90-foot box culvert running beneath I-90, as part of a road improvement contract. The culvert was full of mud from two parallel creeks it spanned.

“We bid it as a per-linear-foot job,” Kulig says. “We had to divert the water with lumber and sandbags

into one culvert while we cleaned the other one. You wouldn’t believe what all was in there. There were tree branches, construction boulders, brush, debris, lots of garbage. We nearly lost a wheelbarrow and two shovels when there was a flash flood from a thunderstorm.

“We thought there was about a foot of mud in it, but it turned out there was actually 18 inches. We thought the job would take two weeks, but it took closer to four.”

#### Value added

Kulig prefers that his crews learn up front, without having to go through that kind of experience, so he stresses getting as much information as possible before work begins.

“My guys are all capable of carrying on an intelligent conversation with a client and figuring out a problem,” he says. “If you’re going to get to the heart of a problem, you’ve got to have dialogue. I tell them, ‘Don’t be afraid of the customer. Go talk to him, find out what he needs. You’re the one who’s going to make it better, so they’re depending on you. You have to appear confident, so they have confidence in you.’”

Kulig starts new hires by spending a couple of weeks on the truck with them, showing them the daily routine. “Once you start the task, the customer doesn’t bug you every minute,” says Kulig. “Soon the guys know what they’re supposed to do: initial assessment, job extent, technical stuff. I take care of the administrative work.”

Kulig keeps his eye on the industry, and has strong opinions about what is coming. “Hydroexcavation is going to get bigger, especially in the big city,” he says. “It helps you work in tight-packed utilities without piercing them the way an excavator

might. It minimizes physical and visible disruption, and it eliminates the time it takes for permits to cut curb. It ends up being a cheaper job, too, because you don’t have to rebuild everything you’ve destroyed.

“If I saw a young guy just getting started today, I’d tell him: No matter what you think you need for startup capital, figure three times that much. Everything has accelerated: insurance costs, vehicle registration, parts and labor, permits and licensing. Everything has gone up, and everyone has raised their prices to a great degree. You play with a lot of bucks, but not much of it sticks to you.”

And yet the success continues to stick to A-K Underground. ■

#### MORE INFO:

##### Dresser Roots

877/363-7668

[www.rootsblower.com](http://www.rootsblower.com)

##### FMC

281/260-2121

[www.fmctechnologies.com](http://www.fmctechnologies.com)

##### Guzzler Mfg. Inc.

815/672-3171

[www.guzzler.com](http://www.guzzler.com)

##### Hi-Vac Corp./Aquatech

800/752-2400

[www.hi-vac.com](http://www.hi-vac.com)

##### Robuschi USA Inc.

877/424-1020

[www.robuschiusa.com](http://www.robuschiusa.com)

##### VacAll Industries Inc.

800/382-8302

[www.vacallindustries.com](http://www.vacallindustries.com)

##### Vactor Manufacturing

815/672-3171

[www.vactor.com](http://www.vactor.com)

**Come In We're**  
**OPEN**  
[www.cleaner.com](http://www.cleaner.com)



# Pipeline Cleaning & Maintenance Equipment

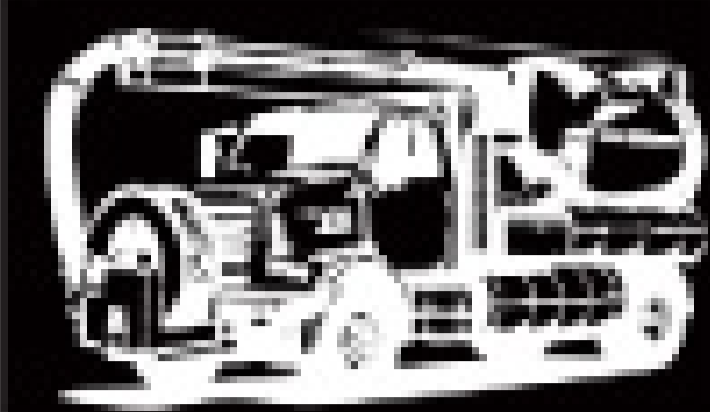

for

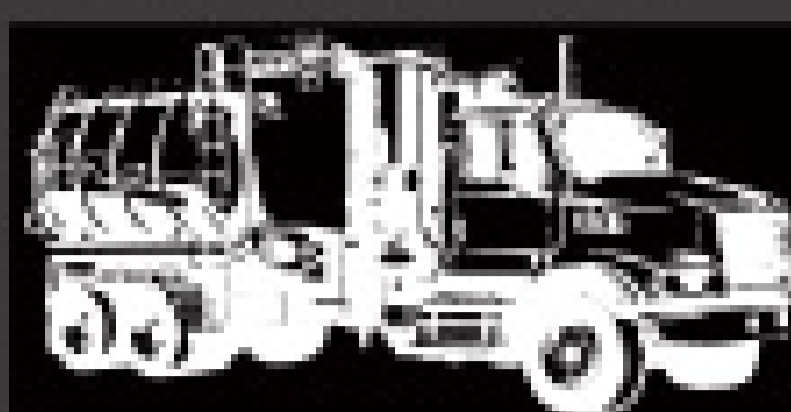

## JETTERS & JET VACS

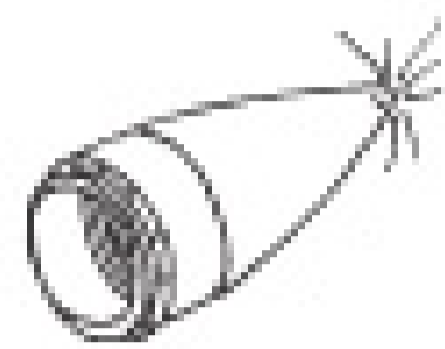

### Penetrators

1/4"-15°	\$31.00
3/8"-15°	\$36.00
1/2"-25°	\$41.00
1/2"-25°LT	\$44.00
3/4"-12°	\$48.00
3/4"-12°LT	\$56.00
1"-12°	\$61.00
1"-12°LT	\$72.00



### Aluminum Grease

3/4" or 1"-17° ...\$105.00

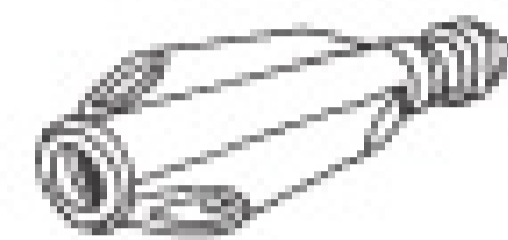

### Truder

1".....\$315.00



### Shark

1".....\$435.00  
1" Big Shark.....\$555.00

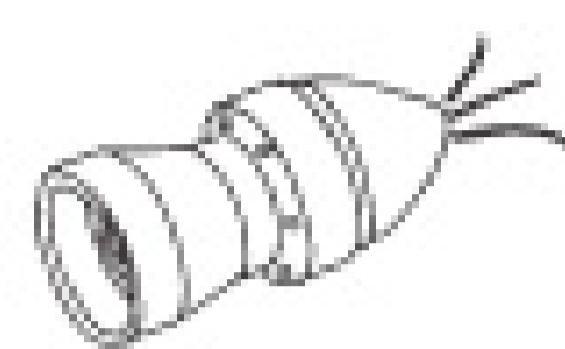

### Radial Bullet

1/4"-30° or 40°	\$18.75
3/8"-30° or 40°	\$21.75
3/4"-18° or 35°	\$44.00
3/4"-18°/24°	\$46.00
1"-18° or 30°	\$59.00
1"-15° or 30°	\$55.00
1-1/4"-18 or 35°	\$85.00

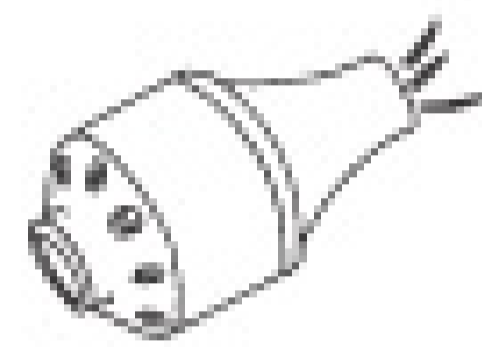

### Aluminum Sand

3/4"-24°	\$125.00
1"-17°/24°	\$138.00
1"-24°	\$125.00

### Stainless Steel Nozzles

1/8"	\$26.00
1/4"	\$28.00
3/8"	\$34.00
1/2"	\$48.00
3/4"	\$52.00
1"	\$92.00

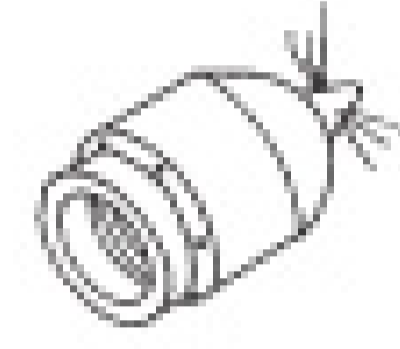

### Steel Sand

1"-12° .....\$59.00

### NEW Storm/Culvert Floor Cleaner Nozzles

MANY OTHER STYLES, SHAPES & SIZES AVAILABLE

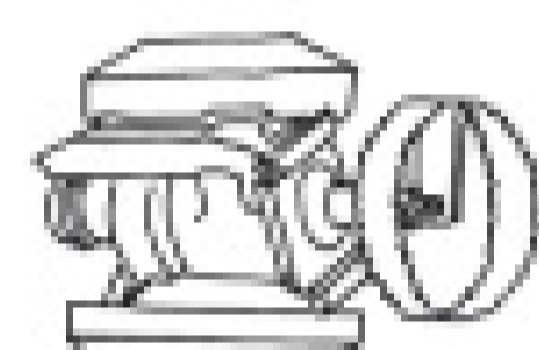

### Sewer Hose Guides

#### TigerTail™ Style

3" x 36"	\$42.00
2" x 36"	\$34.00

with 24' rope



### Swivel Joints

#### T-M® Style

90° or Straight, 6000 psi	
3/4" & 1"	\$169.00
1-1/4"	\$174.00
1-1/2"	\$432.00
2"	\$547.00

### Root Cutter Assemblies

<b>Skid Mounted</b>	
w/flat blades	\$815.00
w/concave blades	\$850.00
w/spiral blades	\$850.00
<b>Donut Mounted</b>	
w/flat blades	\$790.00
w/concave blades	\$835.00
w/spiral blades	\$835.00
<b>Lateral Mounted</b>	
w/flat blades	\$762.00
w/concave blades	\$825.00

Assemblies come with one ea. of 6, 8, 10 and 12" blades, saw blades, hub, skids, etc.



### Clamps

<b>Power Clamps</b>	
8"	\$11.00
3"-6" available	
<b>King Clamps</b>	
8"	\$24.00
4"-6" available	
<b>Bandlock® Clamps</b>	
8"	\$18.00
3"-6" available	
<b>Quick Clamps</b>	
8"	\$21.00
3"-6" available	



### Ball Valves

<b>Dyna Quip® Style, Stainless Steel, 3000 psi</b>	
1"	\$145.00
1-1/4"	\$190.00

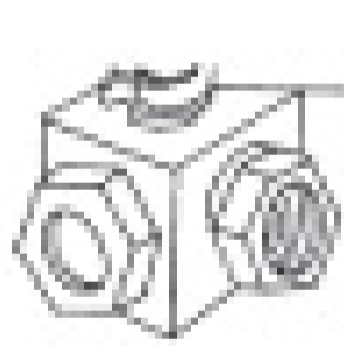

### Hycon® Valves

2 & 3-way Ball Valves

<b>5000 psi</b>	
1/2" 2-way	\$65.00
3/4" 2-way	\$89.00
1" 2-way	\$119.00
1-1/4" 2-way	\$226.00
<b>4500 psi</b>	
3/8" 3-way	\$115.00
1/2" 3-way	\$160.00
3/4" 3-way	\$180.00
1" 3-way	\$190.00
1-1/4" 3-way	\$440.00



### Saw Blades

4"-18"

### NEW Chain Root Cutters

4"-48", All Stainless Steel, No Lubrication



### HD Washdown Gun

25 gpm @ 850 psi  
1/2" Inlet .....\$140.00

### Parker & Piranha Jetter Hose

1/8"-1-1/4"

Pipe/Sewer Plugs • Hose Reels • Aluminum Intake Tubes  
Kanaflex™/Rubber Debris Hose • Full Line Of Warthog Nozzles

**Toll Free: 800-365-6583**  
**www.cloverleaftool.com**

Full Catalog Online with Prices



SARASOTA, FLORIDA • PHONE: 941-739-0707 • FAX: 941-739-0001

CALL FOR OUR COMPLETE CATALOG WITH PRICES

# RHINO



### "Mary A" Manhole Cover Extractor

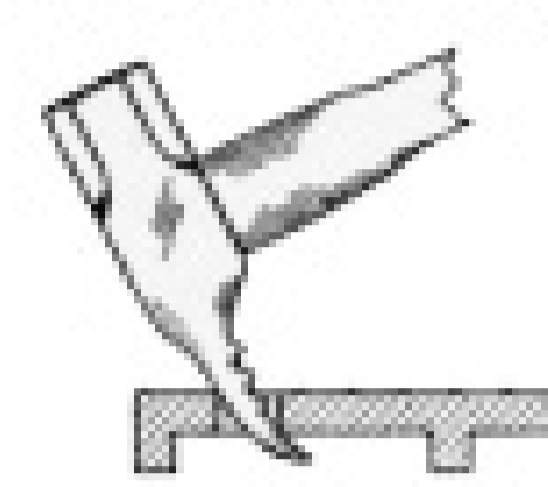
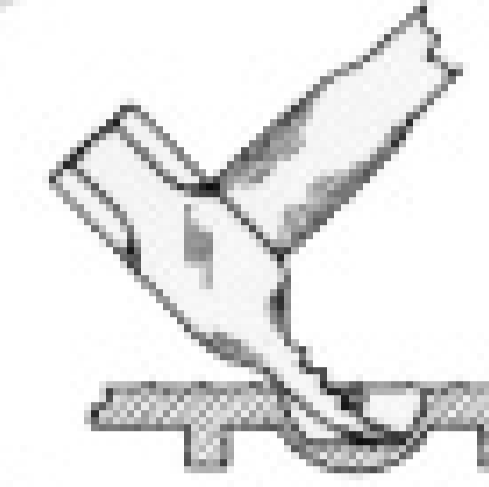

• Manhole cover extractor used for inspections and systems maintenance.

• Combination sledge hammer and pick/pry bar. **MADE IN USA.**

• Tapered saw-tooth pick fits 5/8" or larger drain holes and most pick slots.  
• 12# (4140) ASTM A148 cast steel head breaks frozen covers free easily. Serrated edge strengthens pick-end and eliminates possibility of tool becoming bottlenecked in the cover.

• Two tools in one enables a worker to carry only one piece of equipment into the street.  
• Top quality handle constructed of fiberglass.  
• Model # "MARY A" Patent No. 5865425.

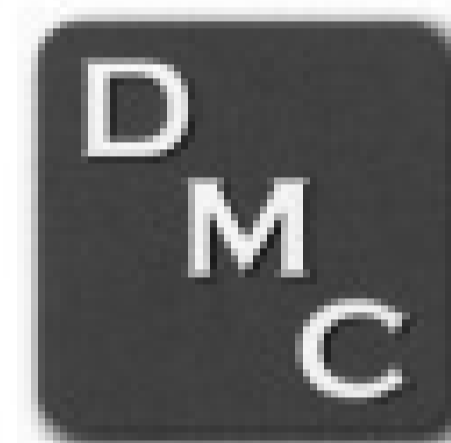

## DOUG MEADOWS COMPANY, LLC

**1-800-588-3684**

325-692-1053 • Fax 325-695-7954

Website: [www.dougmeadows.com](http://www.dougmeadows.com) • E-mail: [doug@dougmeadows.com](mailto:doug@dougmeadows.com)

# Ratech Electronics Limited

CCTV video pipeline inspection systems & equipment

## ELITE SD

For the Plumbing Professional

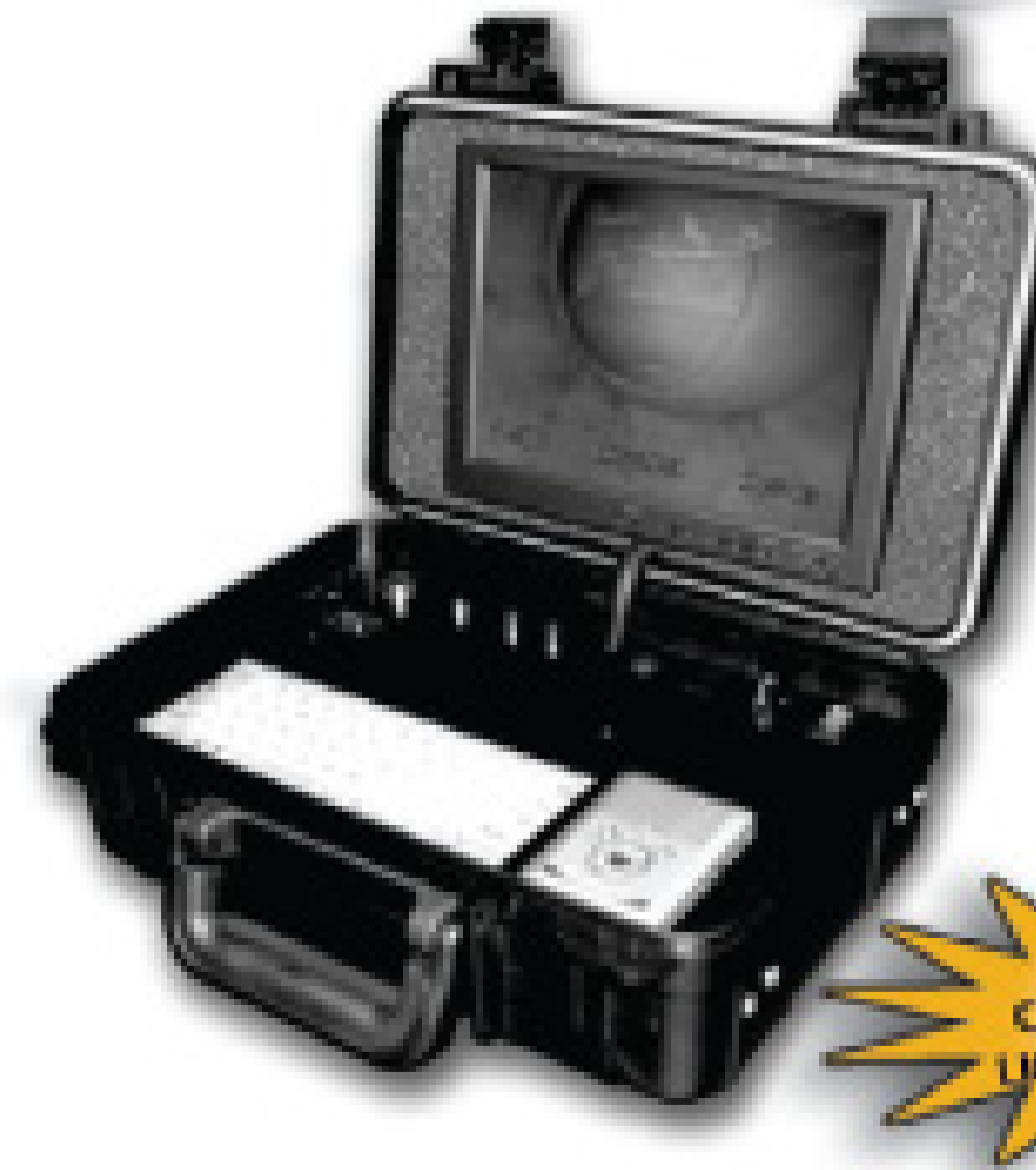

- Light weight portable inspection system for pipes 2" to 12" in diameter
- Super compact size - light weight 10.4 lbs
- Records digitally directly on a SD card
- On-Screen display of Distance, Data, and Time/Date
- 9" High resolution flat LCD monitor

Available with our NEW Self-Leveling Color Camera!

toll free: 1-800-461-9200  
905-660-7072  
[www.ratech-electronics.com](http://www.ratech-electronics.com)



See Everything.

# HELP YOUR BUSINESS CLEAN UP

Our range of models brings water cleaning challenges down to size.

Designed for today's cleaning professional, Putzmeister Water Technology's mobile high and ultra-high pressure water jetting equipment offers maximum performance, mobility and efficiency. With pressures up to 40,500 psi, our products are ideal for everything from paint stripping and rust removal, surface cleaning and jet cutting concrete to hydrodemolition and resurfacing of concrete.

**Putzmeister**  
WaterTECHNOLOGY

For more information on our full line of products, including AquaJet computerized robotic hydrodemolition equipment and TST personal protective equipment, call or visit us online:

Phone 281-449-2100 • Fax 281-449-2106  
[www.putzmeister.com](http://www.putzmeister.com)

DISTRIBUTOR OF:



Personal Protective  
Equipment

**AQUAJET**  
SYSTEMS AB

DOT approved trailers.



SD 250



350 MG



DYNABOX 350



TD 170

**GLOBAL PIPELINER**  
WHOLESALE TO THE PIPELINING INDUSTRY

"NO CONTRACTS, NO BULL,  
JUST GREAT PRICING  
AND SUPPORT."

- 2" up to 110" through a single access
- Increase revenue by up to 1 million plus Dollars
- Cure times of 2 hours in any weather (no boiler needed)
- Training Included
- Ongoing technical and marketing support
- In most cases compatible with your current equipment
- NSF & IAPMO certified
- Financing available



866.513.0998  
[WWW.GLOBALLINING.COM](http://WWW.GLOBALLINING.COM)



# All In!

When you receive *Cleaner* each month there is no need to bluff.

Join 25,000 of your industry peers each month who welcome *Cleaner*, for the unlimited value it brings them. Each issue will show you new tools, tips to save on expenses, money-saving deals and much more.

800.257.7222  
[www.cleaner.com](http://www.cleaner.com)

Subscribe today  
to guarantee  
your winning  
hand!

# "We Service What We Sell"



By now, everyone knows that Jack Doheny Supplies is a world leader in the sale of new and remanufactured equipment. We are also the industry leader in "after sale" service. With our \$5 million dollar inventory of parts and accessories, over 200 late model rental units and unmatched service personnel at our nationwide locations; Jack Doheny Supplies has the means to "Service what we Sell".



Vector Sewer Cleaners



Industrial Vacuum Loaders



Hydro Excavators



Cusco DOT Units



Sewer Equipment Co. Jetters



Pipeline Television Inspection Equipment

## Jack Doheny Companies



"World's Largest Distributor of Sewer Cleaning, Air Handling and Street Sweeping Equipment"

[www.dohenysupplies.com](http://www.dohenysupplies.com)

## Your Source for Ultra High Pressure Hose

Servicing both the Waterblast & Coatings Removal Industries with Hose & Accessories

- Hoses for working pressures 10,000 to 50,000 psi
- BlastPro® Flexlances with Duralife™ Outercover
- Supply Hoses up to 1" ID
- NPT 15K rated fittings and adapters
- Complete range of medium and high pressure valves and fittings

**SPIR STAR**

10002 Sam Houston Center Drive • Houston, TX 77064  
(281) 664-7800 • (800) 890-7827 • Fax: (281) 664-7850  
Visit us on the web at: [www.spirstar.com](http://www.spirstar.com)

© 2008 SPIR STAR, Ltd.

# Ratech

## Electronics Limited

CCTV video pipeline inspection systems & equipment

**MINI PEEK**  
For the Plumbing Professional

- New affordable entry level system
- Portable inspection system for pipes 2" to 8" in diameter
- Ultra compact size and easily transportable - 25lbs
- Built-in 512Hz transmitter
- 1" Ruggedized BW Camera
- 100 feet of cable
- RCA jacks for VCR or DVD recording

**Compact and Light Weight All-in-One System**

toll free: 1-800-461-9200  
905-660-7072

[www.ratech-electronics.com](http://www.ratech-electronics.com)



**See Everything.**



**GET MORE JETTER  
FOR YOUR DOLLAR!**



**STB2511H-MAX**

**Full Featured Jets with Powered Reels:**

**SK4007V** 23 h.p. Briggs 7GPM @ 4000 PSI... \$9950

**STB2511H** 24 h.p. Honda 11 GPM @ 2500 PSI... \$11699

**SK3012K** 29 h.p. Fuel Injected Kawasaki 12 GPM @ 3000 PSI... \$13995

**STB2020V** 35 h.p. Briggs 20 GPM @ 2000 PSI ... \$19699

**STB4018DT** 49 h.p. Hatz Quiet Diesel 18 GPM @ 4000 PSI... \$39950

**Trailer Models starting at \$7499**

[www.camspray.com](http://www.camspray.com)

**800-648-5011**

**AMerik FIBER Spot Repair**

Engineering, Inc. Point Repair for Sewer and Storm drains

**Benefits:**

- Keep rehab work you find in your company
- Calculations and support for municipal acceptance
- Complies with ASTM 2019 liner specifications
- Competitive price, low first cost, no license fee
- Field training and support • Territories available

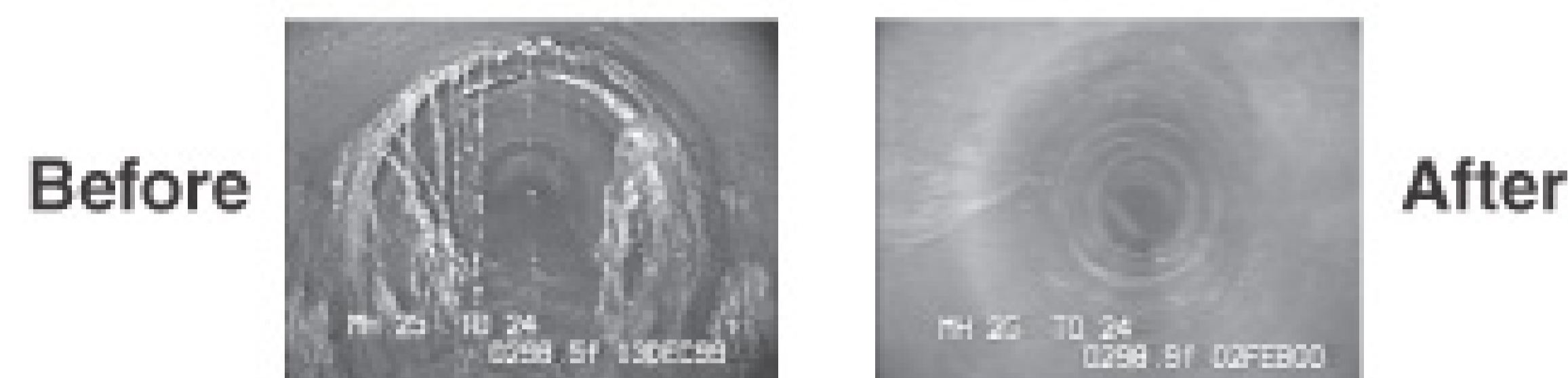

**Proprietary Features:**

- Proven product with 10 year history
- Liners 6 to 45 inch diameter and 2 to 150 feet long
- No plugs required, works in various pipe cross sections
- Flexible liner folds and bends easily for manhole entry
- Positive 45 minutes steam cure in hot or cold weather

**Contact Erik Nielsen (770) 335-3201**  
for available territories, product information  
and pricing or submit request thru web site  
[www.AMerikSupplies.com](http://www.AMerikSupplies.com)

**AMerik Engineering, Inc.**  
2600 Ainsley Ct., Marietta, GA 30066

**FACTORY DIRECT CABLES  
FOR LESS!**

Draincables Direct manufactures drain cleaning cables to fit nearly every brand of machine. We stock a full line of blades, holders and fittings. We offer high quality products, competitive prices, fast shipping and reliable customer service.

**1.800.421.4580**  
[www.draincables.com](http://www.draincables.com)

4370 Moline Martin Road  
Millbury, OH 43447  
PH: 419.838.6090  
FAX: 419.838.6071

*Prompt order shipment*



a division of Service Spring Corp.  
**DRAINCABLES**  
*direct*

# METAL SEPTIC TANK MARKERS

## A Great Way To Advertise And Grow Your Septic Service Business!



Adhesive or 6" PVC Ground Anchor Installation Available.

- 4" Disc - Aluminum or Stainless Steel 16 Ga.
- Deep 3D Embossed Copy for Permanent Legibility
- 10 to 30 Year Warranty
- Laser Engraved Custom Copy Insert



800-248-2080  
www.almetek.com

908-850-9700  
908-850-9618 Fax

Almetek Industries, Inc.  
2 Joy Drive  
Hackettstown, NJ 07840



# FIRST... BEST... ALWAYS!

## FIRST...

with a full flow low profile riser and open drum slot allowing for smooth even hose wraps that don't pinch, kink or stress the hose.

## BEST...

and largest selection of high quality, professional grade hose, cord and cable reels for the air, water, oil and electric industry.

## ALWAYS...

100% pure Coxreels quality in every reel we design & build.

**Safety Makes Sense**

USA MADE - USA QUALITY - USA SUPPORT

**800-COX-REEL**

**COXREELS®**

Toll Free: 800-269-7335 • Fax: 800-229-7335  
Email: info@coxreels.com

[www.coxreels.com](http://www.coxreels.com)

Int. Tel: 480-820-6396 • Fax: 480-820-5132

Your Reel Source



# CUSTOM DRILLED NOZZLES

## SIX PACK KIT™



**NOW OFFERING JETTING HOSE!**  
CALL FOR A QUOTE

- Each nozzle is **custom drilled** to match your pump's flow and pressure specs for **optimized nozzle performance**.
- Custom drilling means **your choice of spray patterns**.
- Each nozzle is made with **heat treated 416 stainless steel** for superior corrosion and wear resistance, and rated up to 10,000 psi.
- Most orders shipped within **one business day**.
- **100% satisfaction guarantee**.

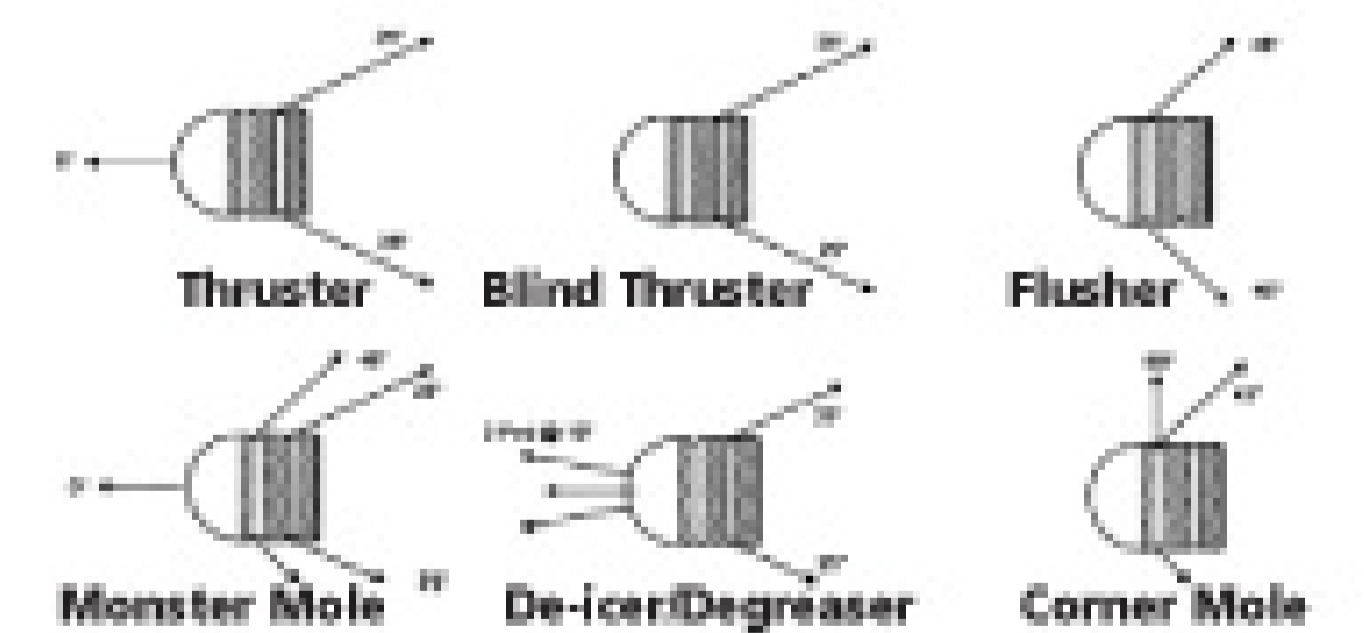

NPT Size	Price	Savings*
1/8"	\$138	\$32
1/4"	\$149	\$33
3/8"	\$159	\$35
1/2"	\$173	\$39

\*Compared to individual prices

**CALL TOLL FREE: 877-457-2782**  
North Royalton, OH 44133 • [www.aquamole.com](http://www.aquamole.com) • Fax: 440-237-2987

# Ratech Electronics Limited

CCTV video pipeline inspection systems & equipment



## PLUMBER'S MATE

For the Plumbing Professional

**Push or Crawl ... It is up to you!**  
**Interchangeable Push or Crawl System**

- Ratech systems can now be used as both a push AND a crawler system
- Simple connector links crawler to existing camera system
- Uses the TORPEDO crawler to inspect 4-8" pipelines
- Simple kit allows you to change from a push to crawl system under 5 minutes

**NOW COMPATIBLE WITH RATECH MAINLINE CRAWLERS**

toll free: 1-800-461-9200  
905-660-7072

[www.ratech-electronics.com](http://www.ratech-electronics.com)

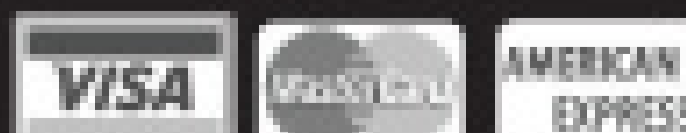

See Everything.

# YOUR RIG + OUR TOOLS

*the equation for optimum sewer cleaning performance.*

**Nozzles . Saws & Cutters . Hoses & Swage Tools  
Sewer Cleaning Machines . Pumps and More...**

For over 25 years Shamrock Pipe Tools has been helping municipal sewer service contractors achieve unparalleled results with high precision tools for every type of pipe cleaning project.

Shamrock's excellence in design, materials and manufacturing processes provides our customers with increased efficiency and productivity, outstanding tool performance and reliability, along with an excellent return on investment.

Call or visit us online for more info on our complete range of pipe cleaning tools and accessories.

**SHAMROCK  
PIPE TOOLS, INC.®**



EXCELLENCE IS REFLECTED IN EVERYTHING WE MAKE.™ ... 800.633.7696 ... WWW.SHAMROCKTOOLS.COM

**SoilJet**®  
by  
Advanced Hydro Dynamic, Inc.



**Truck and Trailer Mounted Vacuum Systems**

*Custom Built To Meet Your Needs!*

- Hydro-Excavation
- Custom Jetter and Combo Units
- Custom Filtration Retrofits
- Cyclones
- Vacuum Booms
- Tanks
- Parts
- Custom Fabrication
- Proto-Typing

[www.soiljet.com](http://www.soiljet.com)



2901 S. Highland Dr. 4-C  
Las Vegas, NV 89109  
Phn 702-259-6677  
Fax 702-361-9612

**Louisville**



February 25-28, 2009

[www.pumpershow.com](http://www.pumpershow.com)

# PRO-CONDOR VAC

INDUSTRIAL PUMPOUT STATION

*There is no substitute for professional pumping equipment*

- Ideal for grease trap pumping
- Extremely maneuverable, can go just about anywhere
- Pumps fast, 60 GPM, 60 gal. capacity
- Will not blow 15 amp breakers
- Will not overflow
- Has odor control technology
- Comes complete with everything needed for pumping
- Factory direct with factory support

Call today for complete information and specifications on the industries' most complete portable pumpout unit.

**Toll Free 800-367-0972**

**Westmoor Ltd.**

P.O. Box 99  
Sherrill, New York 13461

**NOW 30% More Power!**



On The Web At: [www.westmoorltd.com](http://www.westmoorltd.com), e-mail: [pumps@westmoorltd.com](mailto:pumps@westmoorltd.com)

## Trap-Cleer

*Quality Sells ~ Sell the Best*

**Are you making MONEY?**



**BEST PACKAGING - BEST PRODUCTS - BEST PRICES**

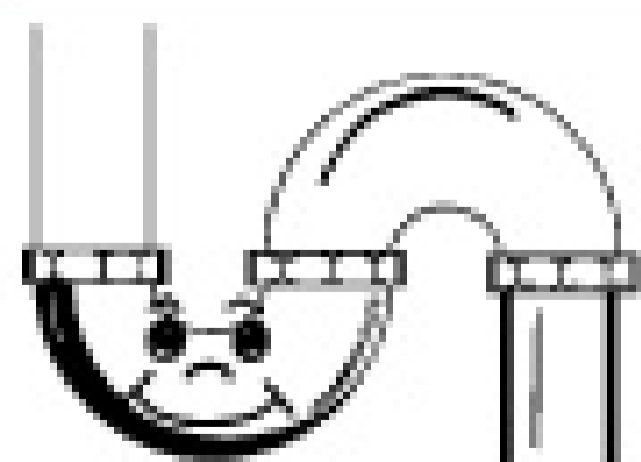

Call Today for Your **FREE** Sample

**1-800-223-3083**

920-826-4083 • Lenzyme, Inc.

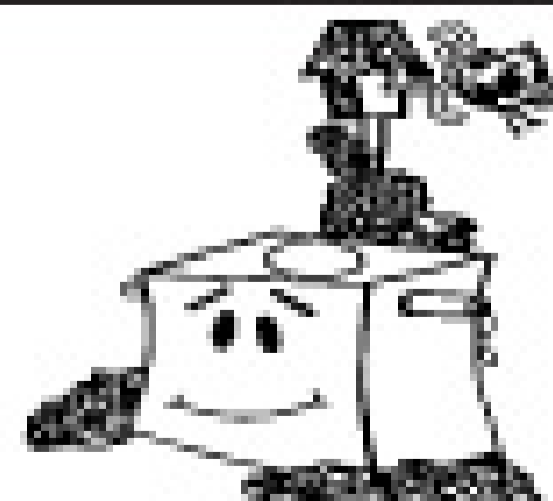

**Grease and Waste Solutions**

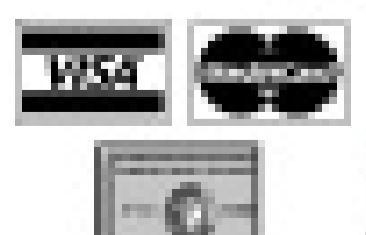

## Ratech Electronics Limited

CCTV video pipeline inspection systems & equipment



### ELITE DVD RECORDER

For the Plumbing Professional

- Light weight portable inspection system for pipes 2" to 12" in diameter
- High quality DVD recorder with built-in Hard Drive
- Includes built-in 512Hz transmitter
- On-Screen display of Distance Counter, Data, and Time/Date
- 15" High resolution flat LCD monitor



Available with our **NEW** Self-Leveling Color Camera!



toll free: 1-800-461-9200  
905-660-7072  
[www.ratech-electronics.com](http://www.ratech-electronics.com)



**See Everything.**

# Sealing the Chimney

Various grouts and sealants help contractors and their customers protect against clear water infiltration in manhole structures

By Scottie Dayton

**M**anholes account for a substantial amount of infiltration to wastewater collection systems, and yet they are relatively cost-effective to remediate.

Industry manufacturers offer numerous products to help seal these structures, whether made of concrete, masonry, or other material. Many of these same products also work well to repair or prevent deterioration in lift stations, wet wells, catch basins, and other structures.

The products listed here represent a wide range of materials and methods of application. To get a fuller picture of the possibilities for cost-effectively sealing manholes, consult the manufacturers' web sites.

## Waterproof protection

**Brushbond** two-component acrylic polymer-modified cement-based coating waterproofs and fills holes, cracks, and imperfections, permanently sealing aged brick, block, cast-in-place, and precast manholes. It protects walls from positive and negative hydrostatic pressure. The coating comes in pre-measured units, applies easily with a smooth consistency, and bonds to porous and nonporous surfaces. **PrimeLine Products Inc.:** 407/772-8131; [www.primelineproducts.com](http://www.primelineproducts.com).

## Injected sealer

**Prime-Flex** polyurethane chemical grouts are designed for manhole, sewer pipe, and lateral



Prime-Flex polyurethane chemical grouts from Prime Resins Inc.

grouting. The low-viscosity liquid resins are usually injected under pressure into or near leaks. Once the resin contacts water, it forms an expansive closed-cell foam or a gel depending on the material

formulation. The foam can be flexible and resilient (hydrophilic) or rigid, but the cell structure crushes when compressed (hydrophobic). **Prime Resins Inc.:** 800/321-7212; [www.primeresins.com](http://www.primeresins.com).

## Watertight joints

**Conseal CS-102** butyl rubber sealant self-seals joints in manholes, concrete vaults and pipes, box culverts, and other precast concrete structures. Providing permanently flexible, watertight joints, the material is workable in temperatures from 30 to 120 degrees, and has a service temperature range from -30 to 200 degrees F. A high chemical and mechanical bond occurs when the sealant is applied to clean, dry surfaces, and the joints will not shrink, harden, or oxidize with age. Priming is normally unnecessary. **Concrete Sealants Inc.:** 800/332-7325; [www.conseal.com](http://www.conseal.com).

## Sealing chimneys

**Internal Manhole Chimney Seal** prevents excess inflow/infiltration in manholes and stops pavement settling around manhole covers and catch basins. The rubber seals conform to the physical requirements of ASTM C-923, with a minimum 3/16-inch thickness for durability and resistance to puncturing and tearing.

The standard 8-inch internal seal is double-pleated, and the 10-inch-wide internal seal is triple pleated. Extra-wide internal seals have four pleats to allow for a minimum 2-inch vertical and 1/2-inch horizontal movement before stretching the rubber. The rubber's flexibility allows one size to fit a frame/chimney diameter range of more than 20 percent. The seals have a tensile strength of 1,500 psi and are highly chemical resistant. **Cretex Specialty Products:** 800/345-3764; [www.cretexseals.com](http://www.cretexseals.com).

## Hydrophilic polymer

**AV-202 Multigrout** is a polymer solution that reacts with water to form a strong polyurethane film, gel, or foam to prevent water infiltration into manholes, sub-grade structures, and pipes. The nonflammable product handles

AV-202 Multigrout polymer solution from Avanti International.



heavy or light flow conditions, and cures under water. **Avanti International:** 800/877-2570; [www.avantigrout.com](http://www.avantigrout.com).

## CIP for chimneys

The **CIPMN Chimney Works** system has a one-size-fits-all stretchable felt liner with sealed seams and polyurethane coating. Delivered in pre-measured kits, the 100-percent solids, silicate-based, VOC-free resin produces strong bonds with no shrinkage. The liner, vacuum impregnated and cured under pressure, can be installed with minimal equipment and no manhole entry. It resists damage from freezing and thawing, leaves a smooth interior, and accommodates odd shapes. **LMK Enterprises Inc.:** 815/433-1275; [www.performanceliner.com](http://www.performanceliner.com).

## Stopping leaks

**Parson Hydro Grout** is a nonhazardous, low-viscosity hydrophobic polyurethane grout. Mixed with predetermined amounts of Parson Grout Accelerator, it exhibits controlled reaction times from 30 seconds to 3 minutes. The grout cures to a chemically resistant closed-cell foam that stops medium- to high-volume active leaks through hairline cracks in manholes, pump stations, and other structures. **Parson Environmental Products Inc.:** 800/356-9023; [www.parsonenvironmental.com](http://www.parsonenvironmental.com).

## Flow containment

The **RELINER Inside Drop Bowl** is a compact, simple, cost-effective solution for containing the flow of inside drops in manholes. The low-profile bowl attaches with stainless steel expansion bolts and special fully adjustable stainless steel pipe clamping supports to the manhole wall. Its design enables full access and inspection from above without reducing access to areas below.

When used with the RELINER Modular Invert System, the bowl provides fluid containment integrity. Solids and liquids remain together, eliminating erosion of walls and benches, and reducing



hydrogen sulfide emissions. Service is from the street. Applications include new service installations, micro-tunneled services, wet wells, and existing and failed outside drops. Several standard and custom sizes are available. **RELINER/Duran Inc.:** 800/508-6001; [www.reliner.com](http://www.reliner.com).

### One-component sealer

**QM-1s Restore** is a factory-blended, high-strength, cement-based polypropylene fiber reinforced and shrinkage-compensated mortar enhanced with a mono-crystalline quartz aggregate (Granusil). Designed to repair concrete and masonry structures, the product's formulation allows for a monolithic, one-pass application up to three inches thick by low-pressure spraying. Recommended for vertical and overhead repairs to sewer manholes, pipe, tunnels, and other facilities, the one-component blend provides uniform results. It has high early and ultimate compressive flexural and bond strengths, resists sulfate attack, and has extremely low permeability. **Quadex Inc.:** 888/831-1650; [www.quadexonline.com](http://www.quadexonline.com).

### Versatile sealer

**XSeal** is a single-component, closed-cell, hydrophobic polyurethane that is applied during new construction and rehabilitation for assembling chambers, manhole sections, and vaults. It also is used for attaching grade/adjusting rings and manhole frames to the concrete cone. The

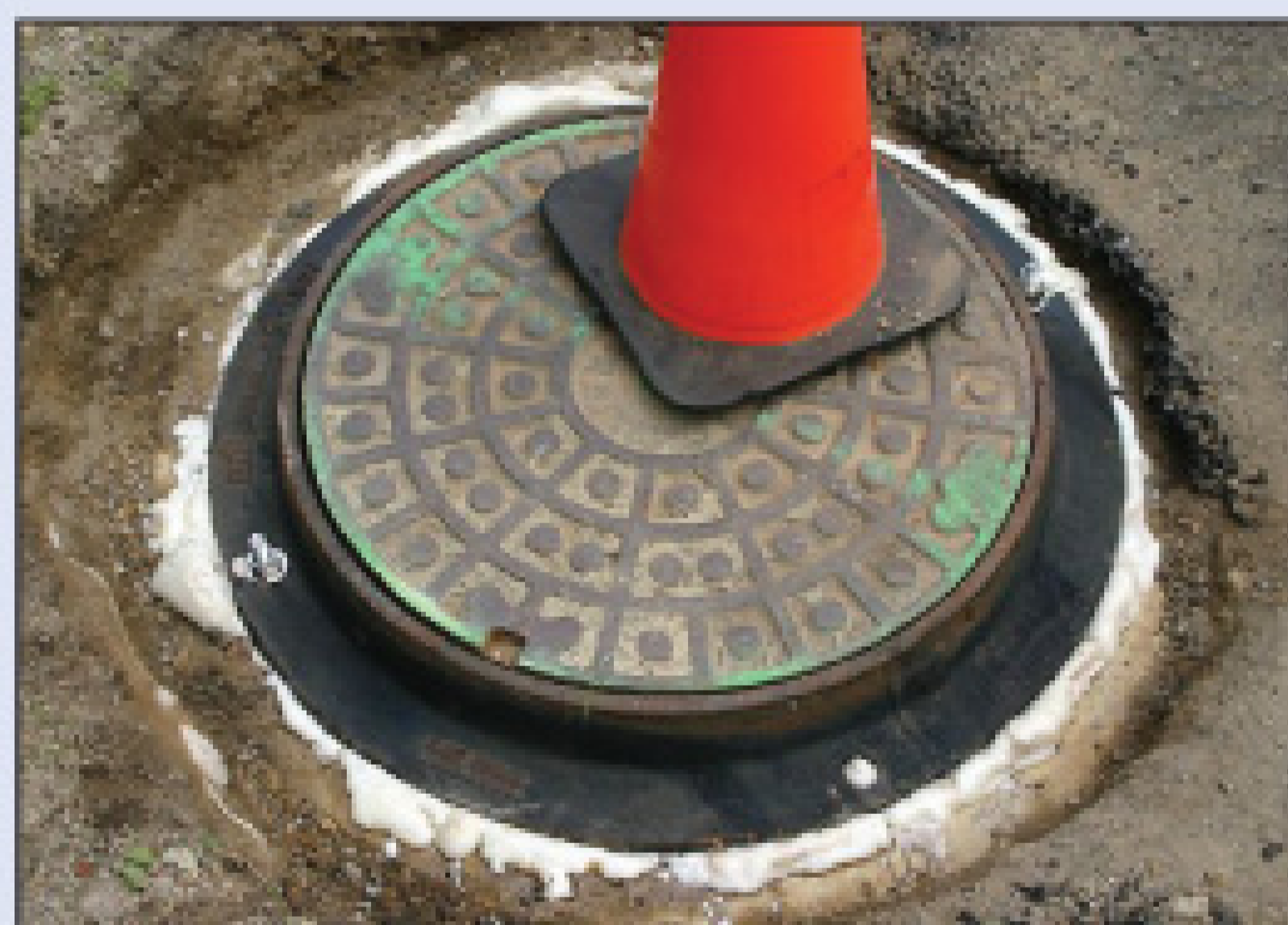

XSeal hydrophobic polyurethane from SealGuard Inc.

product can bond concrete, metals, and plastics, expanding to fill voids and seal all substrates. **SealGuard Inc.:** 866/625-4550; [www.sealguardinc.com](http://www.sealguardinc.com).

### Epoxy sealant

**Perma-Poxy** is a rapid-curing, medium-viscosity modified epoxy resin that repairs manholes, sumps, wet wells, and other structures. A single pass by spray, brush, roller, or trowel creates a 40- to 250-mil thick film that cures reliably even at low temperatures and in moisture. A hard surface typically develops in four hours or less. The resin is highly chemical resistant to acids, caustics, gasoline, and other hydrocarbons. **Perma-Liner Industries Inc.:** 727/507-9749; [www.perma-liner.com](http://www.perma-liner.com).

### Rotary-applied sealer

**SewerGard No. 210RS** is a rotary spray-applied material that protects concrete, steel, and new or rehabilitated substrates from chemical attack and physical abuse. When cured, the material creates an impermeable, high-strength, corrosion-resistant lining for manholes, lift stations, and similar facilities that are subject to infiltration and attack from hydrogen sulfide and acid. **Sauereisen Inc.:** 412/963-0303; [www.sauereisen.com](http://www.sauereisen.com).

### Layered resins

The **SpectraShield** liner is a 100-percent solids, VOC-free system engineered to seal manholes, wet wells, and other structures using multiple layers of polymer resins to impart structural strength, stop groundwater intrusion, restore structural profiles, and bar environmental penetration. Cured-in-place installation causes minimal disruption. The manufacturer states that a 7-foot-deep manhole can be lined in less than one hour. **SpectraShield Liner Systems:** 904/268-4951; [www.spectrashield.com](http://www.spectrashield.com).

### Fast-curing spray

**SprayWall** is a durable, spray-applied, VOC-free polyurethane coating that provides structural enhancement and chemical resistance in under-

ground structures and manholes. The product's formula enables curing to begin in less than 30 seconds, and the structure can be returned to service moments later. The material has a 50-year design life, retaining 70 percent of its original flex modulus. **Sprayroq Inc.:** 205/957-0020; [www.sprayroq.com](http://www.sprayroq.com).

### Stops microbe activity

**Strong-Seal High Performance Mix** is a pure-fused calcium aluminate mortar that protects against microbiological-induced corrosion, but also stops infiltration and restores structural integrity. Tests document that the material protects cement wastewater structures by limiting bacterial activity and thus regulating biosulfuric acid production. **The Strong Company Inc.:** 800/982-8009; [www.strongseal.com](http://www.strongseal.com).



Hydro Active Cut hydrophobic polyurethane from DeNeeff Construction Chemicals.

### Hydrophobic grout

Two accelerants give **Hydro Active Cut**, a hydrophobic polyurethane, the ability to stop even high-volume leaks. In contact with water, the grout expands and quickly cures to form a tough, rigid, closed-cell polyurethane foam that is unaffected by corrosive environments. The material is approved by UL for NSF 61 (potable water). **DeNeeff Construction Chemicals:** 800/732-0166; [www.deneef.com](http://www.deneef.com). ■

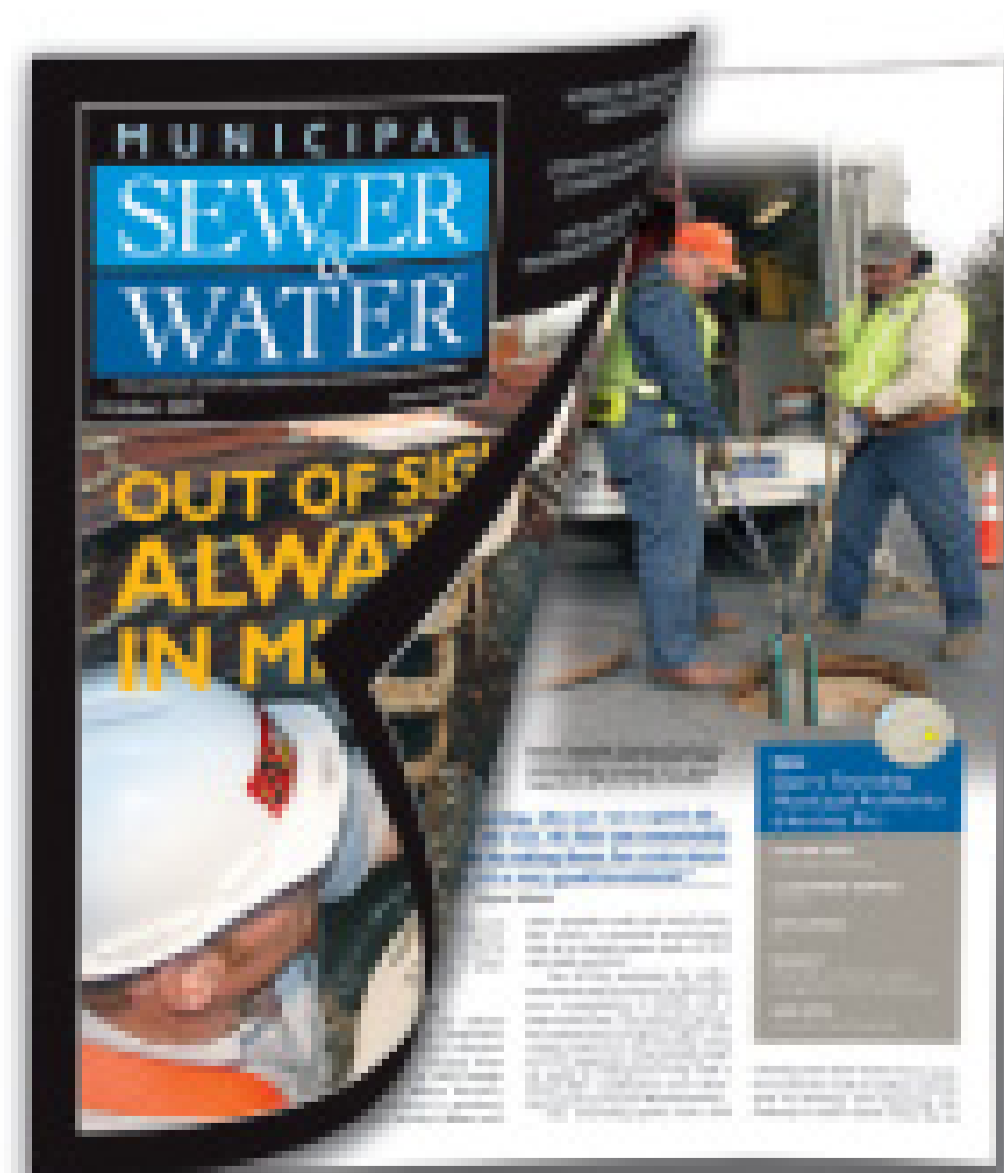

## WHAT'S INSIDE?

Vital information on caring for vital infrastructure.

35,000 municipal and utility maintenance professionals rely on it every month.

**A subscription is FREE.**

[www.mswmag.com](http://www.mswmag.com) or 800-257-7222

# THE PROVEN LEADER IN WATERJETTING EQUIPMENT

## PUMPS & UNITS

- From 100 to 750 HP
- Pressures from 5,000 to 50,000 PSI
- Trailer or Skid Mounted
- Diesel or Electric



## ENGINEERED PRODUCTS

- Shellside Machines
- Rotary Line Cleaners
- Cutting Equipment
- Air Preheater Tools



## WATER JETTING TOOLS

- Nozzles
- Control Guns
- Valves
- Fittings
- Waterblast Hoses
- Rigid & Flex Lances

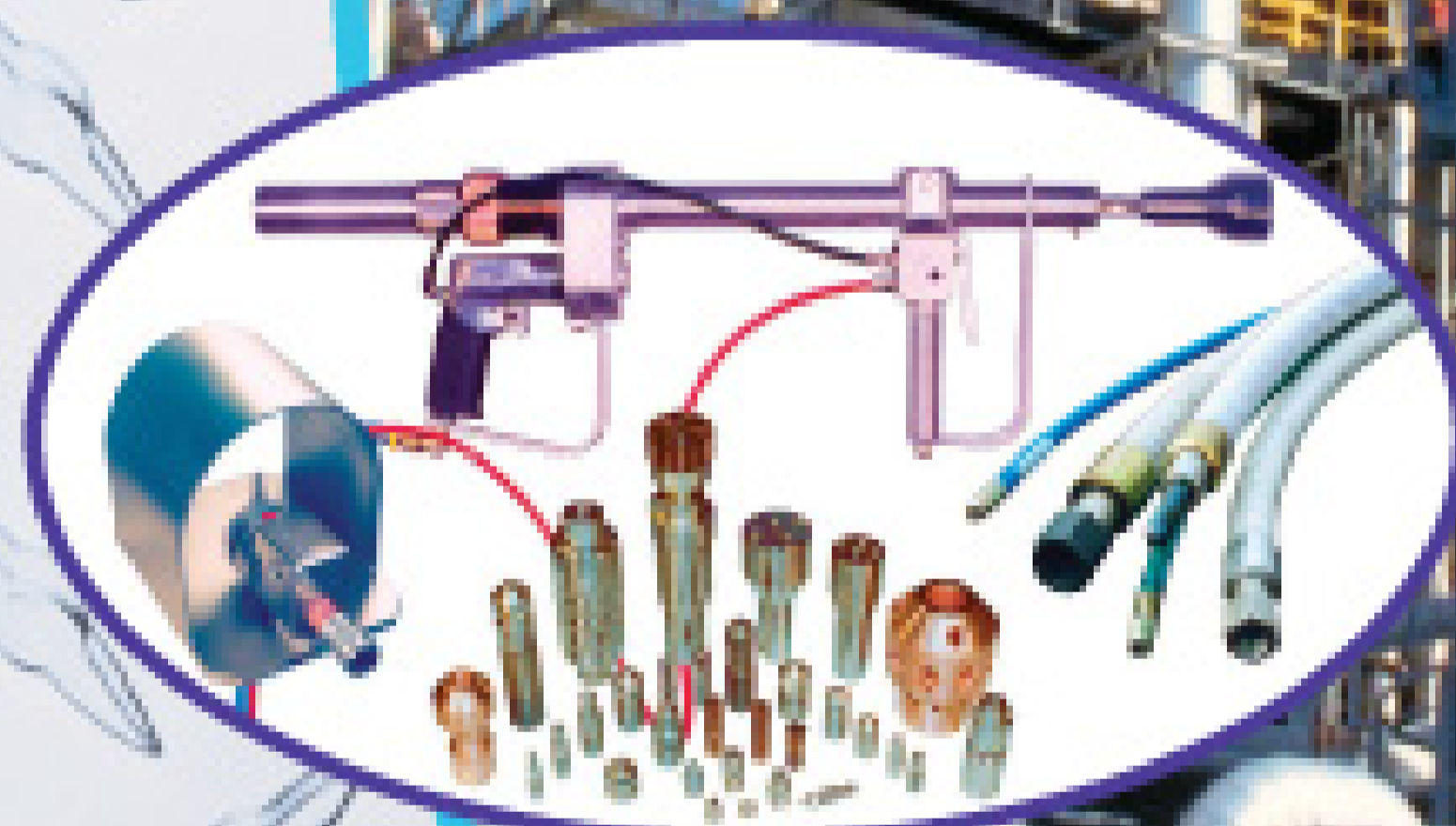

## GARDNER DENVER WATER JETTING SYSTEMS INC.

281-448-5800 • Fax: 281-448-7500

1-800-231-3628

[www.waterjetting.com](http://www.waterjetting.com)

E-mail: [mktg.wjs@gardnerdenver.com](mailto:mktg.wjs@gardnerdenver.com)

R  
E  
N  
T  
A  
L  
S  
A  
V  
E  
S  
C  
O  
S  
T  
S

“The West’s Most Experienced Dealer for Combination Cleaning Trucks”

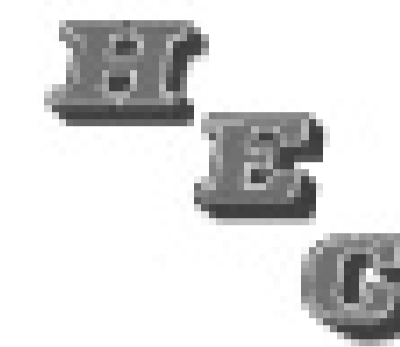

OK Champion

**VACTOR**

**ELGIN**



Pipe Hunter Dealer in

Southern California & Southern Nevada

*Your #1 Vactor Dealer For 2006!*

### Vactor Rentals

Rent a wide variety of Vactor, Elgin and Guzzler Equipment throughout the Western United States

Fresh Reconditioned Units in Stock.

NOW WITH TWO LOCATIONS TO SERVE OUR CUSTOMERS

**Haaker Equipment Company**

2070 White Ave. • LaVerne, CA 91750

**909-598-2706**

**Haaker Equipment Company**

10 E Mayflower Ave. • North Las Vegas, NV 89036

**702-639-0156**



# THE CABLE CENTER • 1-800-257-7209



**24 HOUR TURNAROUND - MIDWEST'S LARGEST FACTORY AUTHORIZED  
REPAIR CENTER FOR GATORCAM, GEN-EYE & SEESNAKE**



## Gen-Eye GL™

Basic Unit Machine Only

- Self-Leveling color camera keeps the water at the bottom of the screen.
- DVD Recorder provides a crisp picture with jitter-free freeze frame.
- Gel-Rod® protects against moisture damage if rod is cut or abraded.
- Built-in full keyboard titler with eight pages of text easily shows your company name and job location.

FREE DELIVERY

## Close Out Sale

Limited Quantities

### Gen-Ear™



List Price: \$2419

Close Out Price: \$1650

**\$1650**

FREE DELIVERY

**Compatible  
with Electric  
Eel® Connectors**

1 1/4" x 8' - \$51.00

1 1/4" x 10' - \$56.00

**BUY  
3 GET 1  
FREE!**

## General J-1450 Portable Jetter



- 1500 psi, 1.7 gpm
- 1-1/2 hp (115V/13 amp)
- Triplex pump with Vibra-Pulse
- 150' 1/4" ID hose

- 4 piece nozzle set
- 30' 1/8" ID hose
- 4 piece nozzle set

**\$1775**

FREE DELIVERY

**Compatible with  
Ridgid® Cables**

5/8" x 7.5' - \$21.00

7/8" x 15' - \$43.75

1 1/4" x 15' - \$68.25



## Close Out Sale

Limited Quantities

### Gen-Eye Junior™ Micro

- 100' of Micro-pushrod for 1-1/2" to 4" lines.

- AC/DC power supply.

- Picture Inverter.

- Built-in text writer.

- Light dimmer control

- Built-in on-screen distance counter - in feet or meters

- Built-in dual frequency transmitter (512 hz & 87 hz) that reduces interference.

**\$2300**

FREE DELIVERY



### Mini-Rooter XP™

Basic Unit Machine Only

**\$485**

FREE DELIVERY

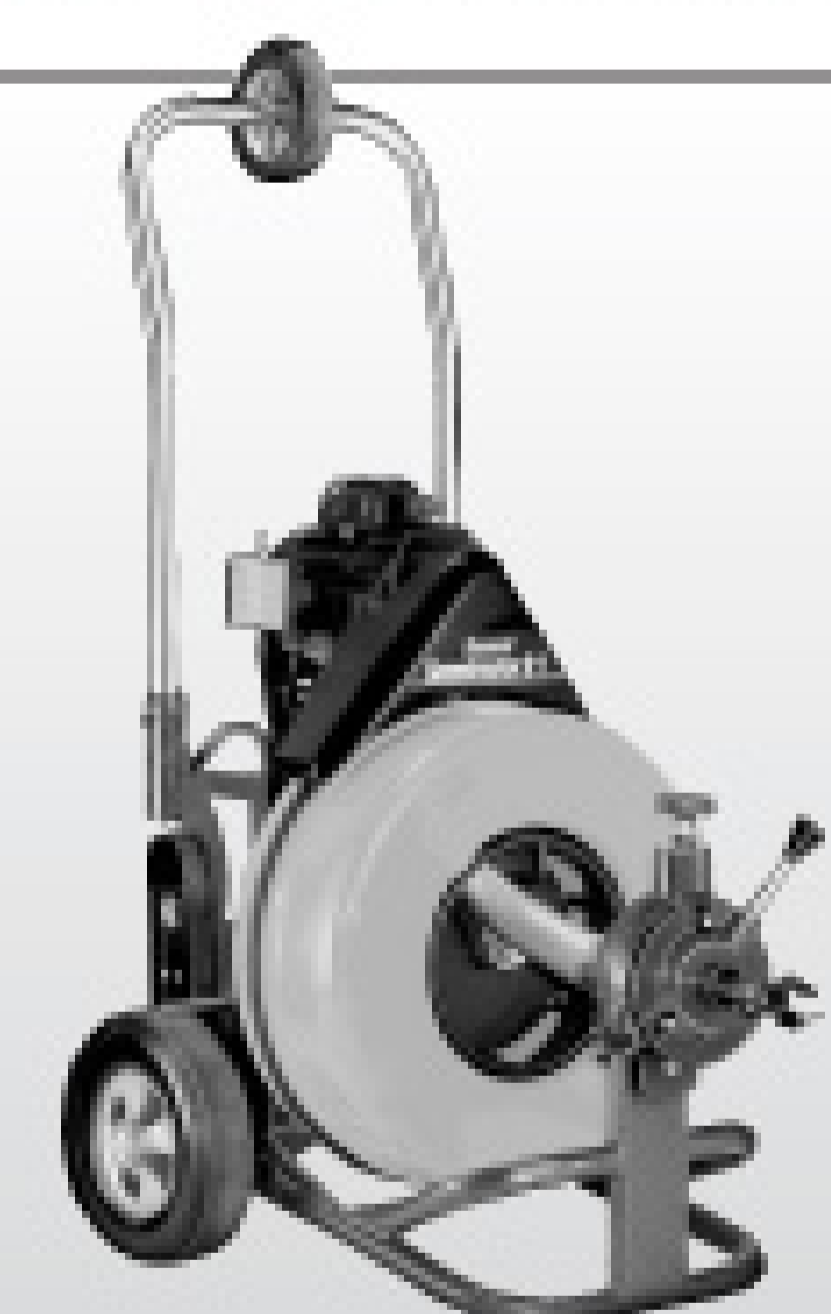

### General Speedroooter 91™

Basic Unit Machine Only

**\$1010**

FREE DELIVERY

**THE CABLE CENTER • 8318 OLIVE BLVD. • ST. LOUIS, MO 63132 • 314-993-3099**

ultra ultra ultra  
**LIGHT – VERSATILE – SAFE**

# ultraSHORE P R O D U C T S



Quick to Install.  
As light as 130lbs.

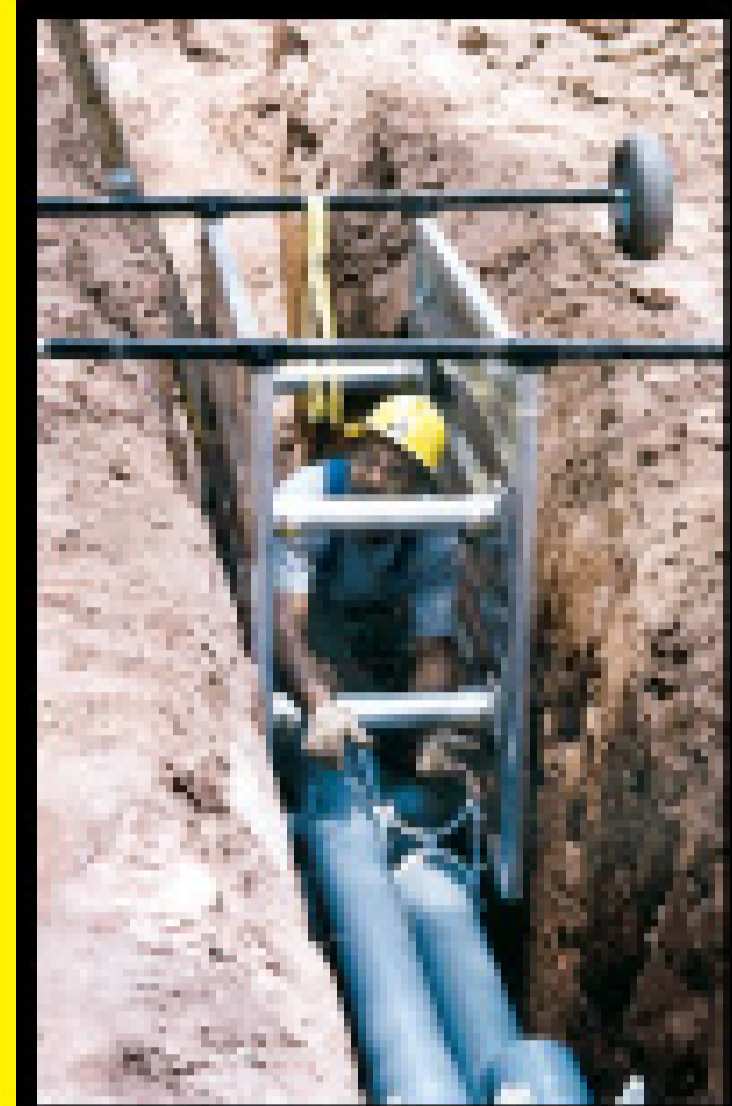

Roll Your Own.  
Optional wheel kit.



Stacks easily with  
2' & 4' high panels.

**This is What Aluminum Shoring Was Meant to be!**



1-800-683-8837

**1-800-SH-ORING**

CALL TOLL-FREE NATIONWIDE • 1-800-746-7464

**www.shoring.com**



*"water as a tool"*

**WOMA**<sup>®</sup>  
CORPORATION

## WOMA High Pressure Systems

help solve almost any Industrial cleaning, maintenance and decontamination problem.

- HIGH PRESSURE PUMPS TO 40,000 PSI
- 25-600 HP HIGH PRESSURE UNITS
- ACCESSORIES TO MEET ANY APPLICATION

*Let us help you more effectively use "water as a tool."*

When quality, performance and reliability matter...  
PHONE: 800-258-5530 . FAX: 732-417-0015

# Central Winnelson

**SeeSnakes™**

Call us for Our  
Lowest Price!



LCD - DVD  
MONITOR  
AVAILABLE

SeeSnakes and  
Locators Ship Free!

AUTHORIZED  
RIDGID SEESNAKE  
REPAIR CENTER

**Ridgid SeekTech®**

Locating Made *Easy*

**Price Too Low  
to Advertise!**

CALL FOR  
SPECIAL RIDGID  
PROMOTIONS

**6% one year financing available.  
Longer lease rates also available.  
Call Keith for details.**

***Buying a SeeSnake?***

**CALL US FOR  
GREAT PRICING  
AND FREE SHIPPING!**

**WE WILL  
NOT BE  
UNDERSOLD**

**– Call Us Evenings and Weekends –  
Keith: 405-602-9155 & Jim: 405-205-3974**

5037 NW 10th • Oklahoma City, OK 73127  
www.centralwinnelson.com

**Toll Free: 888.947.8761**

# **lansas**® PRODUCTS

MANUFACTURED BY VANDERLANS AND SONS, INC.



*Custom Designs Are  
Always™ Available*



*AR™ Plugs*



*Multi-Size Domeheads™  
Front and Back Plugs*



*High Pressure  
Plugs ~ to 150 PSI*

*High and Low  
Pressure  
Joint Tester*



*"Smart Box™" Line  
Acceptance Test Kit*

*Vacuum Pump  
Manhole Vacuum Testing*



*Vacuum Test Plate  
with Protective Cover*

**VANDERLANS AND SONS, INC.**  
 California 1-800-452-4902  
 Atlanta 1-770-509-9309  
 Minneapolis 1-763-428-9290  
[www.lansas.com](http://www.lansas.com)



*"Super Vac™"  
Manhole Vacuum Testing*

Pipeline Inspection Technology

# flexiprobe push rod video inspection systems

**NEW**  
DIGITAL CONTROL  
MODULE!

Pearpoint inspection systems, featuring the **NEW P330+ flexiprobe control module**, bring you all the benefits of advanced digital technology and easy keypad operation, putting you in complete control.

## P330+ flexiprobe system

Ultra-bright 8" (200mm) TFT screen

Quick transfer of video and still pictures via USB and Bluetooth® wireless technology

Durable keypad for easy access to all key functions

Splashproof keyboard for text entry



Waterproof stainless steel/sapphire camera with maintenance-free LED lighting

Easily transportable compact reel

Each system comes complete with a universal easy-fit brush skid set that allows the 1" camera to be used in pipes from 25mm (1") up to 100mm (4") diameter and the 2" camera to be used in pipes from 50mm (2") up to 150mm (6") diameter. Brushes can be conveniently replaced in seconds.

The Bluetooth word mark and logos are owned by the Bluetooth SIG, Inc. and any use of such marks by Radiodetection Ltd is under licence.

To find out more call us Toll Free (800)-688-8094 ext 245 or visit [www.radiodetection.com](http://www.radiodetection.com)



Pearpoint 72055 Corporate Way, Thousand Palms, CA 92276, USA

©2008 Pearpoint, Inc. / Radiodetection Ltd. All rights reserved. The Logo and "flexiprobe" are trademarks owned by Radiodetection Ltd. Due to a policy of continued product development, we reserve the right to alter or amend any published specification without notice. Radiodetection Ltd. is a subsidiary of SPX Corporation

# AquaNoz

"Engineered Solutions"



## Call 1.800.322.0510

Fax: 1.330.722.2698

E-Mail: [jmsales@apclsq.com](mailto:jmsales@apclsq.com)

[www.arthurproducts.com](http://www.arthurproducts.com)

ARTHUR PRODUCTS CO.  
an LSG Mfg Company

## de neef

### Has The Solution To Your Infiltration Problems

With the widest variety of chemical grouts of any manufacturer, *de neef's* product list includes flexible and rigid foams in both hydrophobic and hydrophilic form as well as polyurethane, acrylate and acrylic gels. These products combined with our years of experience will help you bring your water problems under control.

- 1 Control leaks from cracks and joints or around pipe penetrations with our flexible Hydro Active® Sealfoam NF or Flex LV
- 2 Fill voids and stop leaks with our rigid foam Hydro-Active® Cut
- 3 Use our acrylate gel, AC400, or polyurethane gel, Hydro Active® Multigel NF with your TV grouting equipment to stop infiltration through pipe joints and lateral connections

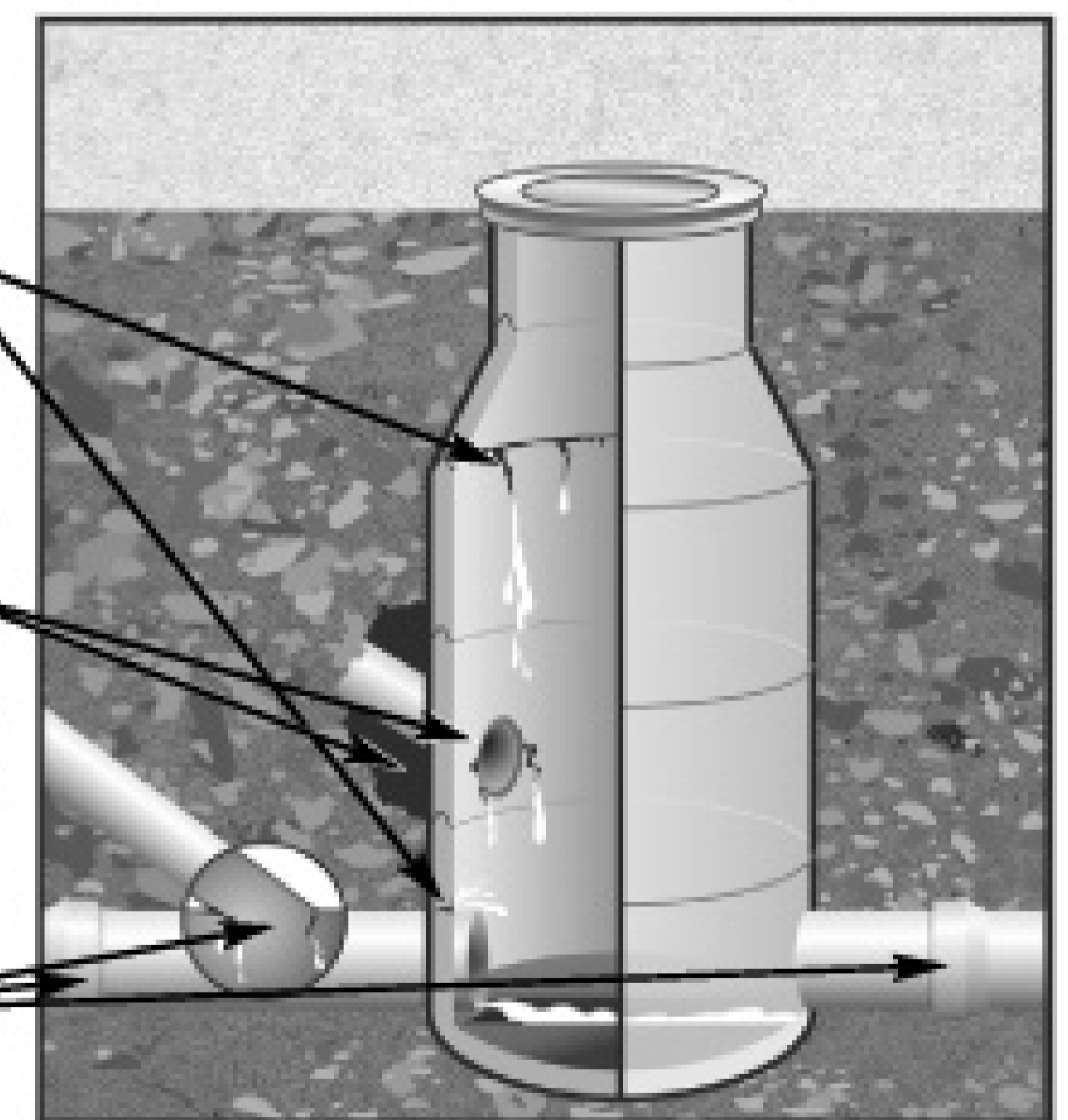

**de neef**® Construction Chemicals, Inc.

5610 Brystone • Houston, TX 77041

Phone: 800-732-0166 • Fax: 936-372-9897

Website: [www.deneef.com](http://www.deneef.com) • e-mail: [info@deneef.com](mailto:info@deneef.com)

# PIPE REPAIR 101

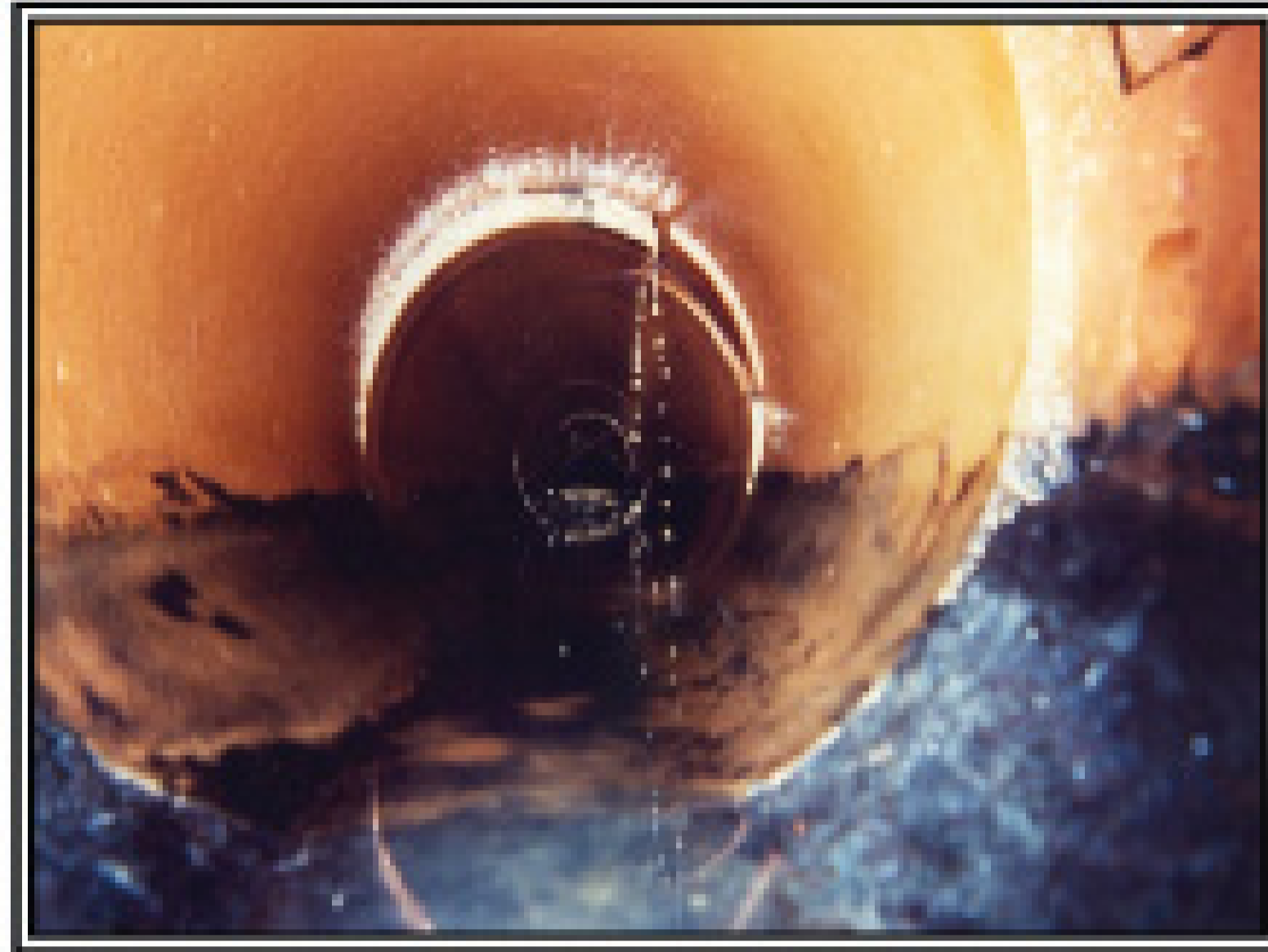

After years of field research and development, Stephen's Technologies is offering classes in the application of their patented internal pipe repair system. Hands-on training at our national headquarters in Florida and or at your location. Toll-Free technical support by installers not sales people



**SIMPLE**

**EASY**

**PERMANENT**

## LATERAL LAUNCHERS

\$7,999.00

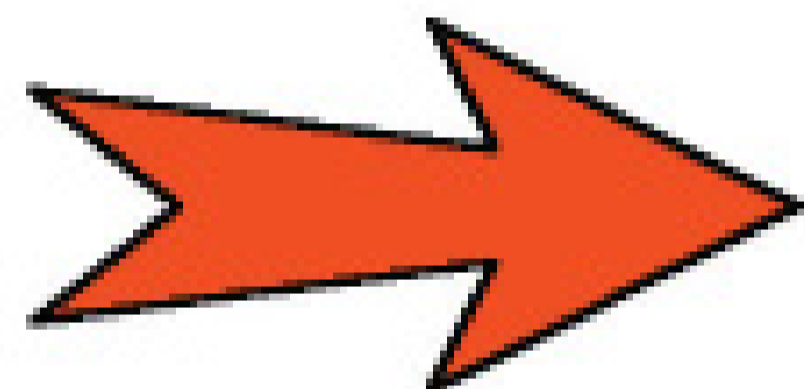

ALUMINUM  
CONSTRUCTION



\$6,999.00

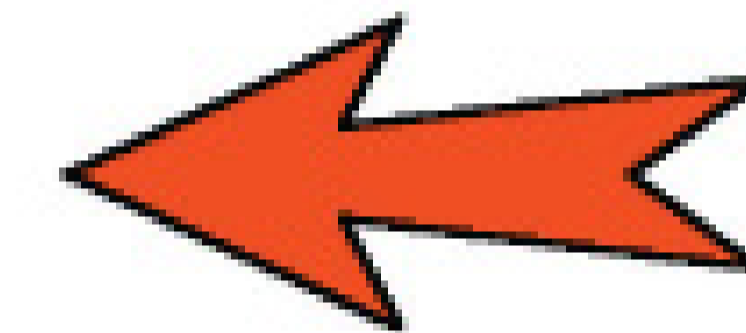

FITS THROUGH DOORS  
ONE MAN CAN CARRY

PLUS SHIPPING AND  
HANDLING

**25% OFF**

4" & 6"

**PipePatch**  
NO DIG Pipe Repair System by Femco, Inc.



**Free Shipping On Orders Over \$2,000**



**STEPHEN'S  
TECHNOLOGIES**

(888) 783-7436 (Toll Free)

Environmentally conscious.  
Technologically advanced.

FOCUSED ON THE WORLD'S UNDERGROUND INFRASTRUCTURE

The image is a composite. The background is a scenic landscape of a mountain range with snow-capped peaks, a dense forest of evergreen trees, and a clear, blue lake that reflects the surrounding scenery. In the bottom right foreground, a portion of a robotic crawler is visible, featuring two large, treaded black wheels with red hubs and a silver metal frame. The overall color palette is dominated by blues, greens, and greys, with the red of the robot's wheels providing a focal point.



## Aries CoolVision Laser Profiler

The CoolVision Laser profilometry is a non contact inspection method used to determine underground piping profiles. The profiler uses an extremely accurate optical triangulation to gather highly precise dimensional results and measurements to accurately give the ovality or liner thickness of any pipe up to 48" diameter. Accuracy of the measurements is .25% of the diameter. The

CoolVision system is easily adapted to any new or existing Aries mainline inspection system.



## Zoom Pole Camera

Aries high resolution camera module used in conjunction with the 432:1 zoom ratio and High intensity detachable LED lighthead, allows you see details that other cameras miss. The wireless operation makes the system extremely versatile and allows you to take it anywhere and transmit the video anywhere. When this system is used with the optional media case with 10" day light readable screen, it allows the user to inspect any pipe anywhere you can get to. For more versatility virtually any reporting software can be added to greater enhance the systems capabilities.



## Pathfinder

**When size and performance matters, Aries Pathfinder is the best 6" televising inspection system available!** The Pathfinder is designed and manufactured in the U.S.A. by Aries Industries, Inc. The high resolution camera module and high intensity LED lighting let you see details that other cameras miss. The brushless drive motors and electronic clutches in the tractor yield longer life, less maintenance and maximum power in a minimum size for optimal productivity. The standard back-up camera with LED lighting helps negotiate bends in the pipe while retrieving system. The Pathfinder is designed and built with the Aries performance and durability that you deserve and have come to expect.

Proudly Manufactured in the U.S.A.

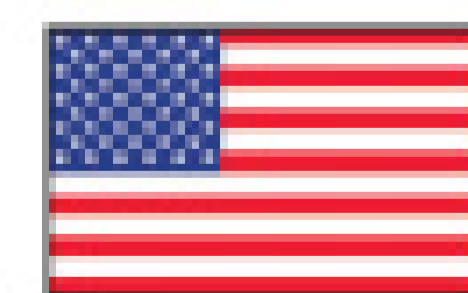

**Wisconsin** – 1-800-234-7205 • **California** – 1-888-285-0366  
**Florida** – 1-800-327-4346 • **Mississauga ONT** – 1-877-730-7010

# ARIES®

www.ariesindustries.com • Email: sales@ariesindustries.com



Greg Thomson of Darr's Cleaning Inc. monitors the progress of a waterjet hose as it is fed into a sewer line in North Baltimore, Ohio. The company's Vactor truck can deliver up to 80 gpm at 2,500 psi. (Photos by Luke Wark)

# Back On Top

**An Ohio contractor weathers personal tragedy, an economic slowdown and a limited customer base by diversifying offerings and courting a wider range of clients**

By Peter Kenter

*Randall Robert Darr (Randy) November 10, 1965 to January 24, 1998.*

That inscription appears on the home page of Darr's Cleaning Inc. of Clyde, Ohio, beneath the names of the owners, Bernie and Roger Darr.

Bernie and Roger lost their brother Randy to a traffic accident, the first in a string of hardships that almost sidelined the business as it embarked on an ambitious expansion plan. There was no insurance policy on Randy's life to help his brothers buy out his share of the business.

There were also loan payments for new equipment, and then the complication of an economic downturn that affected some of the firm's largest customers. Bernie and Roger Darr succeeded with a strategy of continued diversification and growth, offering more to their customers instead of cutting back.

Today, Darr's Cleaning has eight employees, about \$1 million in revenue, and a diverse portfolio of

services, including sewer jetting, CCTV inspection, trenchless pipe repair, and vacuuming.

**Always a family**

The company began a trajectory of slow but steady growth when it was founded in 1960 by Harold Darr as a furnace cleaning service. Harold sidestepped a decline in the furnace business by diversifying in 1967 to offer septic tank cleaning and

portable restroom rentals. The initial fleet consisted of a vacuum truck, a van, and a cable machine.

In 1972, the company took on a partner, becoming Darr & Konst. Four years later, the partnership split into two business entities. The newly formed Konst Cleaning took

on the furnace cleaning and portable restroom businesses, while Darr's concentrated on pipe cleaning and septic tank services.

After the split, Harold Darr's three sons gradually became more involved in the business. Bernie came to work for the company in

P R O F I L E	
<b>DARR'S CLEANING INC. CLYDE, OHIO</b>	
OWNERS:	Bernie and Roger Darr
FOUNDED:	1960
EMPLOYEES:	8
ANNUAL REVENUE:	Approximately \$1 million
MARKET AREA:	Northwest Ohio
SPECIALTIES:	Sewer jetting, CCTV inspection, trenchless repair, vacuuming
AFFILIATIONS:	National Association of Wastewater Transporters
WEB SITE:	www.darrscleaning.com



1976 and Roger 1980. Both bought shares in 1985. Younger brother Randy became an employee in 1987 and a partner in 1988. The trio bought out their father's final 25 percent share in 1991. Harold stayed on as an employee and still pumps septic tanks up to 30 hours a week at age 76.

Clyde is a small town near Lake Erie, about 50 miles east of Toledo

**“With only 6,700 people, Clyde doesn’t have a large enough population to support us. I think people 50 miles away have more of an idea of what we do than people who live five miles down the road. Ohio has 88 counties, and we’ve provided services in 50 of them.”**

**Bernie Darr**

and 80 miles west of Cleveland. The company has direct access to U.S. Route 20, a four-lane highway, and a 10-minute drive connects it with Interstate 80/90, allowing Darr’s to service both cities. The company does work as far from home as the state capital, Columbus, about 100 miles away.

“With only 6,700 people, Clyde doesn’t have a large enough population to support us,” says Bernie Darr. “I think people 50 miles away have more of an idea of what we do than people who live five miles down the road. Ohio has 88 counties, and we’ve provided services in 50 of them.”

**Broadening horizons**

As the company served clients over a wider range, it built its fleet size and offered more services. Local competitors collectively provide the same services, but Darr’s prides itself on being a one-stop shop. “Nobody in the vicinity does everything we do,” he says.

Besides the Vactor unit and septic tank pumping equipment, Darr’s Cleaning owns a trailer jetter from US Jetting, truck-mounted jetters from Sewer Equipment Company of America and Hi-Vac Corporation/Aquatech Products, and a CCTV truck with inspection equipment from Aries Industries Inc.

The company’s trenchless sewer line repair equipment includes a trailer-mounted epoxy pipe lining system from Nu Flow America for repair of pipes from four to six inches, and a point repair technology from Infrastructure Repair Systems for lengths up to five feet and pipe diameters to 21 inches.

But the expansion coincided with family tragedy. While driving



Technician Scott Cheek (left) and company founder Harold Darr watch the monitor of an Insight Vision camera as they search for debris in a customer’s clogged drainage pipe in Bellevue, Ohio.

**DIGITAL REVOLUTION**

Among the more popular services offered by Darr’s Cleaning is CCTV sewer inspection. The company uses flexidata pipe survey software from PipeLogix to provide clients with a video record of each inspection. The firm retains a backup copy in the company archives.

“After years of offering the service, we had more than 700 VHS tapes of CCTV inspections collected on a huge rack of shelves,” says Bernie Darr, a partner in the company. “It was taking up a lot of space.” To help conserve space and to make record keeping easier, the company digitized the full video archive to DVDs. “The entire rack has been reduced to a single shelf,” says Darr.

Some clients still prefer to receive their records on VHS tape. The company is pleased to oblige, but keeps its own backup on DVD or CD-ROM. Reports are also presented to clients in digital format; hard copies are delivered on request.

“It’s all digital now,” says Darr. “We won’t be generating file cabinets full of reports or shelves full of tapes over the next 10 years.”



Above, Harold Darr (left) talks to his son and current owner Bernie Darr after cleaning out a farmer’s septic tank using the company’s 2006 International PayStar 5600 vacuum truck built by Precision Tank & Equipment. At left, Roger Darr (left) co-owner of Darr’s Cleaning, and technician Steve Frate lower a tractor unit with a pan-and-tilt camera from Aries Industries Inc.



Harold Darr mans the controls of the company's 2006 International PayStar 5600 built by Precision Tank & Equipment with 4,000 gallon waste/200 freshwater tank while cleaning a customer's septic tank with his son, Bernie Darr.

to inspect the rebuilding of one of the company's jet trucks in 1998, Randy was killed when a train struck his car at a blind crossing.

"This was one month after we ordered the new Vector," says Darr. "We had talked for two years before that about buying life insurance for ourselves and creating a succession plan, but at the time of the accident we had no life insurance and no plan in place to deal with something like this."

Without an insurance payment to support Randy's family, the company had no choice but to take out a loan to buy Randy's share of the business. "We already had equipment with a loan to pay down," says Darr. "Just as we were expanding, we were hit with two big loan payments at the same time."

#### Triple whammy

The company soon faced more trouble as an economic downturn in 2000 saw established clients fall away and traditional sources of revenue dry up. "We never thought our business would be so dependent on the economy," says Darr. "We found out the hard way that it was. There wasn't as much work as before, and projects that had been on were suddenly off. Then 9/11 happened, and it compounded the problem."

To make matters worse, some clients most affected by the downturn were Darr's largest. A single industrial client accounted for almost 20 percent of Darr's annual

revenue. The company's strategy in response was to diversify.

"We realized we had so many mouths to feed and that the only way to do that was to expand our services," says Darr. "Whenever we saw another need in the market, we went after it. We had to diversify."

The company began to promote services such as trenchless repair, infrastructure point repair, electronic sewer and tile locating, leach bed rejuvenation, and smoke testing. "We're the boys with lots of toys,

**"We had talked for two years before Randy was killed about buying life insurance for ourselves and creating a succession plan, but at the time of the accident we had no life insurance and no plan in place to deal with something like this."**

Bernie Darr

with the knowledge and experience to best serve your needs," says the company web site. But toys cost money, and the company had to be careful where it invested scarce capital.

"Clients aren't using some of these services all of the time," says Darr. "Certain services are just requested in spurts, so we have to maintain a list of offerings that's always changing to keep pace with market demand."

For example, the company doesn't perform a lot of smoke testing, but because that service ties up very little capital, it can stay on the com-

pany roster without financial risk. Purchasing an extra jetting/vacuum truck, on the other hand, would please one or two clients but would stretch the company's resources.

Darr's also became diligent in choosing suppliers and products. "We have a good network of people to supply us, but it pays to shop around," says Darr. "Whether it's equipment, parts, or consumable supplies, the market is always changing and we need to look for good value to help the bottom line." ■

generated by our web site and by word-of-mouth. A good example is an industrial park where we performed some work after the EPA came down hard on them. One successful job led to a series of referrals in the same area."

The company is also aggressively courting the municipal sector, a market far less susceptible to market fluctuations. Roger Darr heads the sales effort and has won contracts with the town of Clyde and surrounding communities. A more vigorous sales effort has even struck up new contracts with old clients, although the company makes sure that no single client dominates its business.

This year, after overcoming significant hurdles, the Darr brothers are confident that the business is on firm footing. "We're responsive to the market, we're busy, we're insured and we have a succession plan in place," Bernie Darr says. "We have slowly come back to being a profitable business." ■

#### M O R E I N F O :

##### **Aries Industries**

800/234-7205  
www.ariesindustries.com

##### **Hi-Vac Corp./Aquatech**

800/800-1016  
www.hi-vac.com

##### **Infrastructure Repair Systems**

877/327-4216  
www.irsi.net

##### **Insight Vision**

262/268-9330  
www.insightvisioncameras.com

##### **Nu Flow Technologies Inc.**

800/834-9597  
www.nuflowtech.com

##### **PipeLogix Inc.**

866/299-3150  
www.pipelogix.com

##### **Precision Tank & Equipment**

217/452-7228  
www.precisiontank.com

##### **Sewer Equipment Co. of America**

800/323-1604  
www.sewerequipment.com

##### **US Jetting LLC**

800/538-8464  
www.usjetting.com

##### **Vector Manufacturing**

815/672-3171  
www.vector.com



*The one stop shop  
for ALL your sewer needs!*

## Factory Direct

Cable machines, Jetters, Locators, Camera systems, Leak detectors and much more!



*Made in the U.S.A.*

Contact us for your **FREE** full line catalog today!

Toll Free: 800-328-8170

Fax: 651-222-1739

Visit: [www.mytana.com](http://www.mytana.com)



We Supply

# TUBING

in ALUMINUM,  
STEEL or PVC

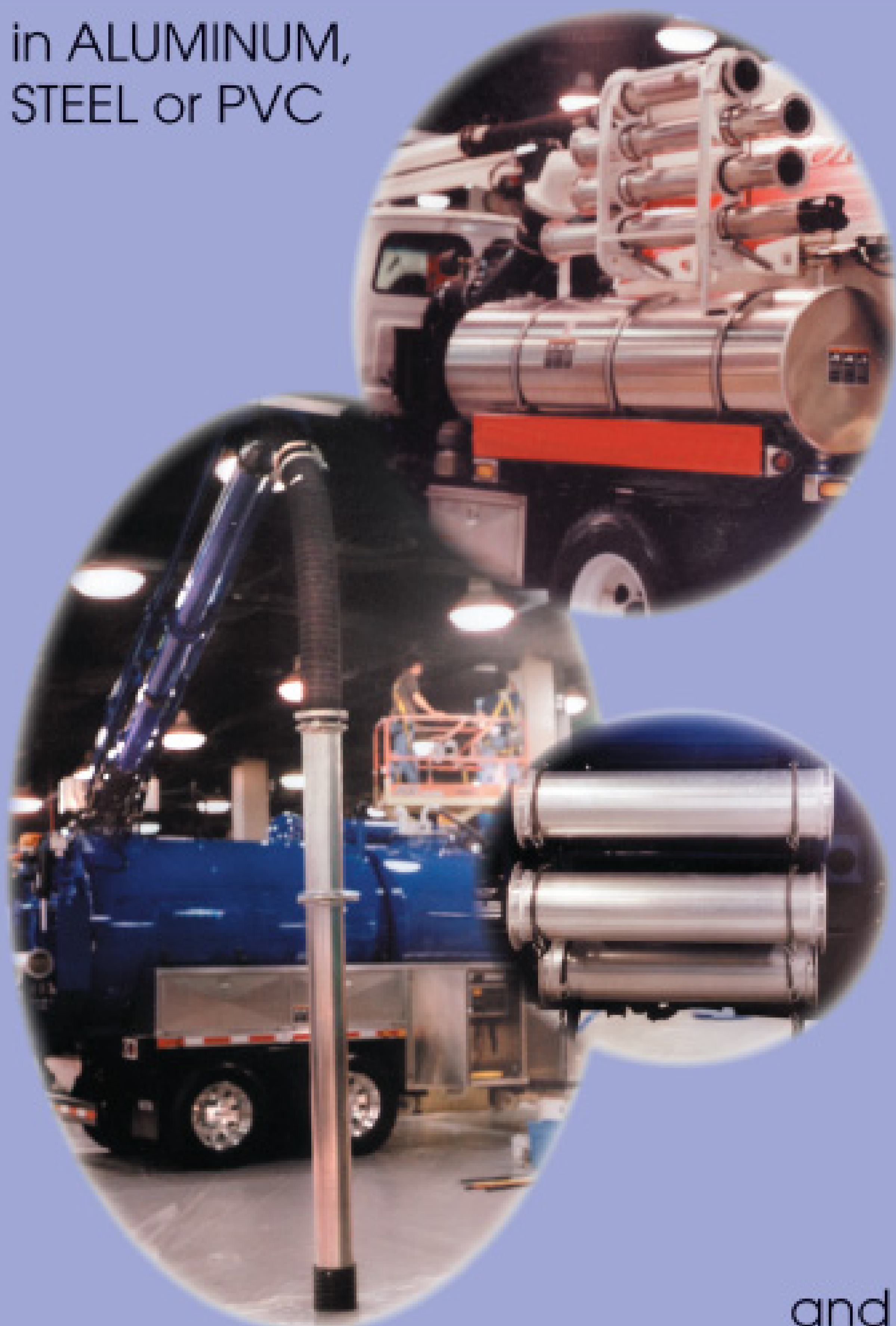

and

# FITTINGS

in ALUMINUM, STEEL, GALVANIZED,  
BLACK STEEL or EPOXY COATED



#### Kroy Manufacturing Plants

**Corporate Headquarters Kroy Industries, Inc.**

522 West 26th St.  
P.O. Box 309  
York, NE 68467  
Fax: 402-362-6566  
Ph: 402-362-6651 or  
888-477-5769

#### Kroy - Olyses

626 S. County Rd. H  
P.O. Box 526  
Olyses, KS 67880

#### Kroy West

P.O. Box 1587  
13400 Hanford Armona Rd.  
Hanford, CA 93232

#### Kroy Midwest

701 S. 17th St.  
P.O. Box 516  
Henderson, NE 68371

*Leaders in cutting technology.*

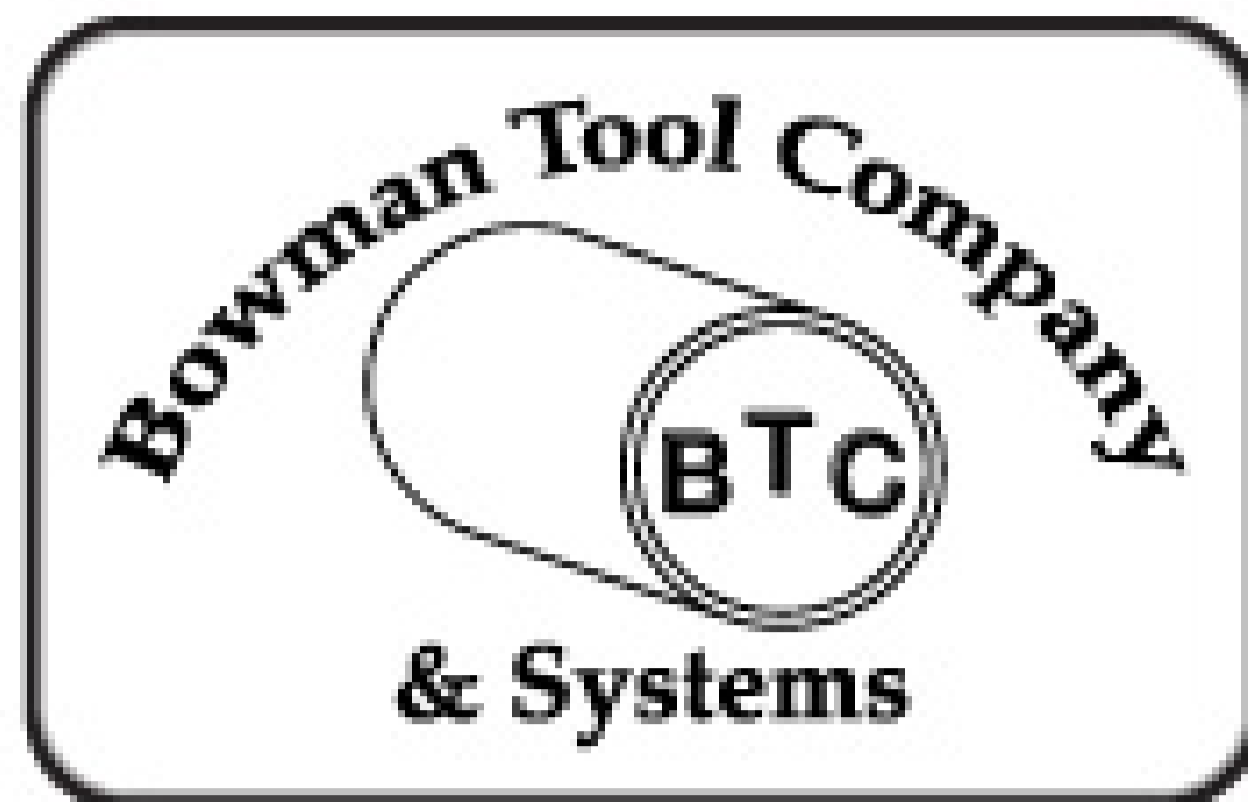

Call Us About  
The New Dominator 300  
Series Cutter For Working  
In 4-Inch Relined Pipe!!



**717-432-1403**  
Fax: 717-432-0152

- » Dominator® Cutters
- » Classic 615's Repair Parts
- » Rugged Jumbo 1236 Cutters
- » Generation II Infinite Controls
- » Redesigned Air Motors

We are a service-minded company.  
Call us for a demonstration of  
the unmistakable Dominator®  
with a range of 4-30" and  
powered by the smaller, quicker  
Generation II Infinite Control.

**FREE TRAINING AT OUR FACILITY ON OUR PRODUCTS!**  
Do you own a Trytek or Aries cutter with leakage issues? We offer  
a remanufacturing program for those cutters as well as air motors.  
**CALL US FOR DETAILS!**

[bowmantoolco@earthlink.net](mailto:bowmantoolco@earthlink.net) • [www.bowmantool.com](http://www.bowmantool.com)

# LAPLACE EQUIPMENT

RENTALS, SALES & SERVICE

- **WATERBLASTERS:**  
PRESSURE TO 40K,  
FLOW TO 100 GPM
- WATER JETTING TOOLS
- HYDRO-MOWERS
- 3D NOZZLES
- ROTATING NOZZLES
- HIGH PRESSURE HOSES
- LANCES
- FITTINGS
- TIPS
- SUPPLIES
- EXPERIENCED TEAM  
FOR PLANNING,  
TRAINING & SETUP

CALL  
985.652.5210  
FOR YOUR  
WATERBLAST  
PROJECT  
SOLUTIONS

[WWW.H2OBLAST.COM](http://WWW.H2OBLAST.COM)

# FRANCHISE NEWS

## Paul and Saunda Kitchen Mr. Rooter® franchise in Santa Rosa, Calif.

*Paul and Saunda Kitchen are only in their 30s, but they have the wisdom of plumbers much older. They've created a positive work environment that encourages their team to grow and succeed while taking care of their customers.*

*But the Kitchens don't stop with just their shop; they are leaders, mentors and role models for the entire Mr. Rooter network. Paul serves on the Mr. Rooter advisory council, and Saunda started a fund that helps franchisees with travel expenses to annual conferences.*

*The Mr. Rooter Corporation has recognized this dynamic duo with the Franchisee of the Year, Sales Leader of the Year and Excellence in Leadership awards. They were recently named to the 'Forty Under 40' list of professionals in their community.*



Photo: Saunda and Paul Kitchen

### Why did you buy a Mr. Rooter franchise?

**Saunda:** We were amazed at the camaraderie the Mr. Rooter franchisees shared, and we immediately wanted to be a part of it. We wanted to want to come to work. Having fun at work and being a part of something bigger than you is so rewarding. Owning a Mr. Rooter franchise lets us be in business for ourselves but not by ourselves.

**Our business is at the level it is because of the education and technology Mr. Rooter provides.**

### How have you grown your business?

**Saunda:** When we first started we thought we would cap out at five trucks, but we now have a 22-vehicle fleet with more than 30 team members. We attribute the growth to the positive work culture we created. We constantly train our team on technical aspects as well as personal development, including goal setting, balancing work and home life, among many other topics.

**We were amazed at the camaraderie the Mr. Rooter franchisees shared, and we immediately wanted to be a part of it.**

### What impact does the Mr. Rooter brand have on your business?

**Paul:** It has a phenomenal impact. Our business is at the level it is because of the education and technology Mr. Rooter provides. Mr. Rooter is a well-known and well-respected brand in our community.

### How have your lives and business changed since you became a Mr. Rooter franchisee?

**Paul:** We've surrounded ourselves with the fantastic network of fellow Mr. Rooter franchisees. Being affiliated with such a dynamic group allows us to break goals we didn't know we were capable of setting in the first place. We learned to work on the business - not in it.



### IS FRANCHISING RIGHT FOR YOU?

Find out today at  
**800-298-6855**

Or visit us online at  
**www.MrRooter.com**  
and click on  
"Franchise Opportunities."

Learn how the established systems and on-going support of Mr. Rooter can help start or grow your business.

Exclusive territories are available in the United States and Canada.



**Are you ready to take your business to the next level? Call today and find out what Mr. Rooter® can do for you.**

*This advertisement is not an offering. An offering can only be made by prospectus. Mr. Rooter MN Reg. No.: F-2356. 1020 N. University Parks Dr. Waco, TX 76707*

# PROTOTEK TOOLS ARE A BLUEPRINT FOR SUCCESS.

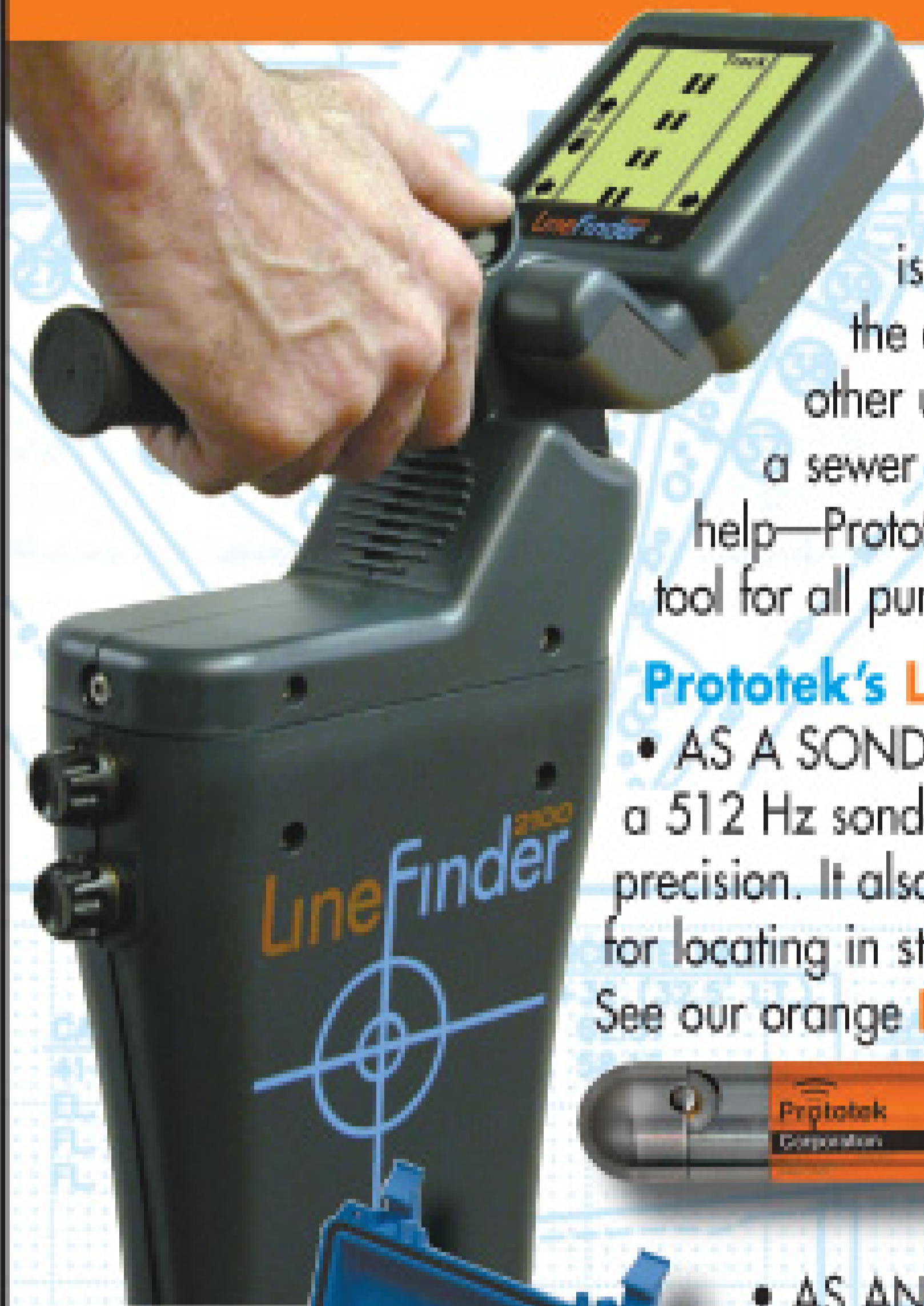

Whether you're 'down home' or 'downtown' a locating job is enough of a challenge without the added hazard of disturbing other utilities while you're servicing a sewer line. No need to call in extra help—Prototek's LineFinder 2100 is the tool for all purposes.

### Prototek's LineFinder 2100

- AS A SONDE LOCATING TOOL, locate a 512 Hz sonde or camera with speed and precision. It also works with 16 Hz sondes for locating in steel or ductile iron lines. See our orange LMJ-6 below.

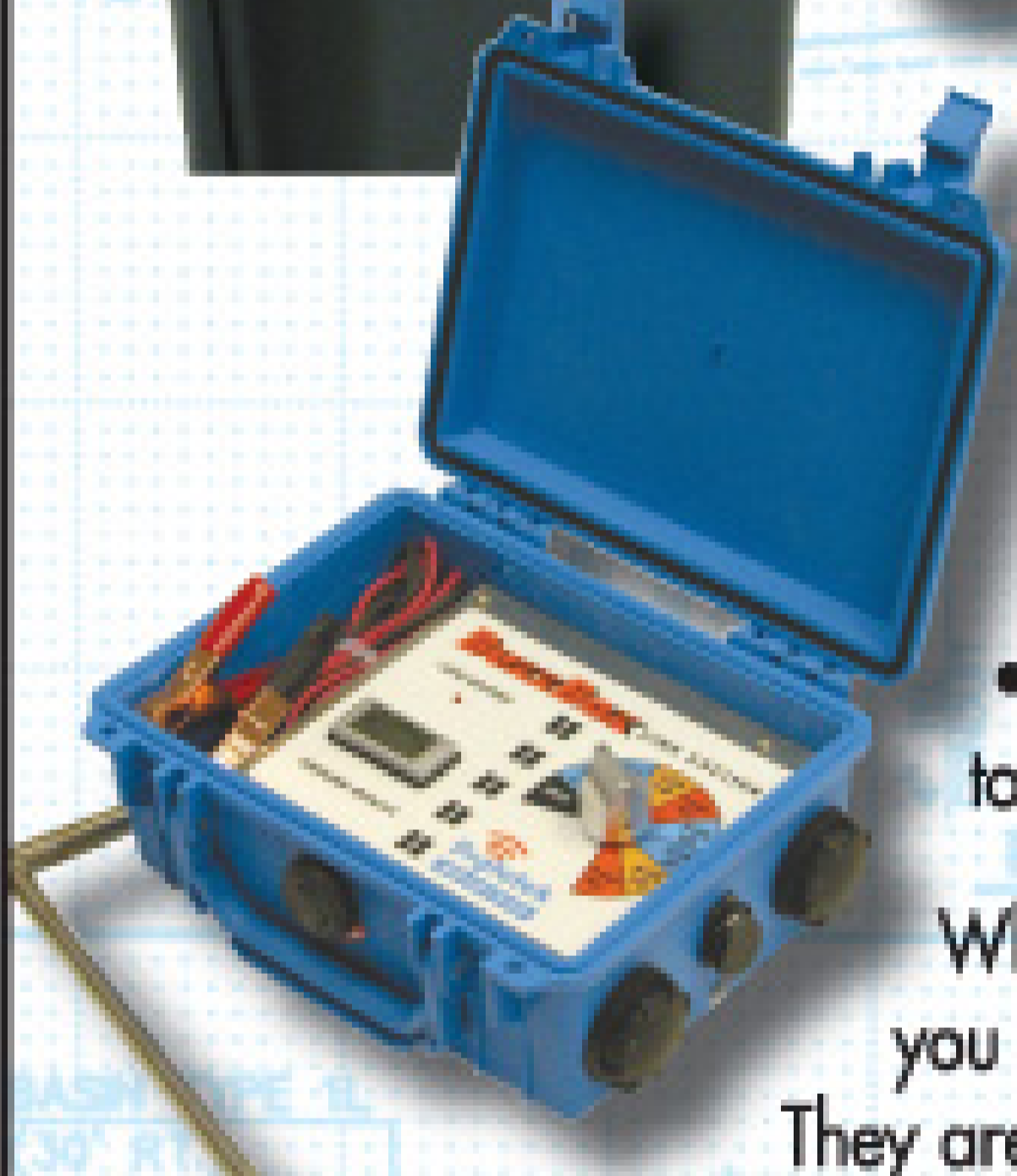
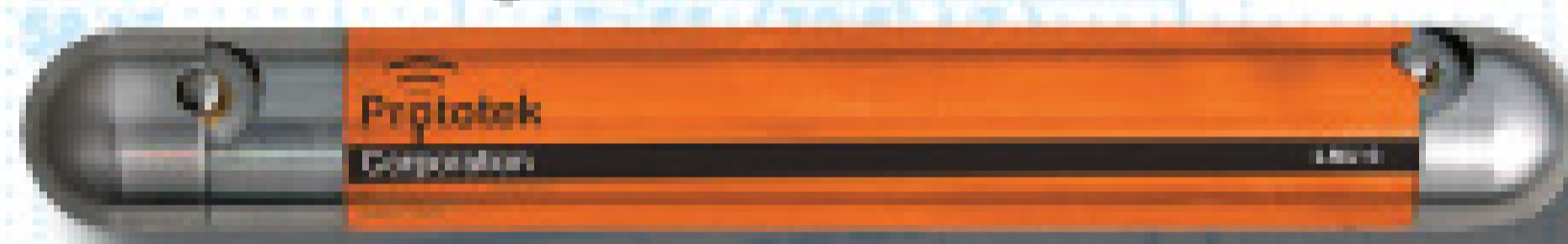

- AS AN ACTIVE LINE TRACING TOOL, detect and map underground utilities so you know where *not* to dig by teaming it with the Blue BuzzBox for conductive or inductive tracing at 4 standard frequencies.
- USE AS A PASSIVE LINE TRACING TOOL to trace energized 60 Hz power lines.

Whether it's pipe locating or line tracing you need, you can depend on Prototek tools. They are well designed, made to last, and easy to learn. You can depend on Prototek service, too. Call us today and let us show you how easy success can be.



# Prototek

BREAKING NEW GROUND UNDERGROUND

800-541-9123



www.prototek.net Email: prototeksales@prototek.net



## They want a grout survey report!

### RELAX! flexidata's got you covered.

the easy solution to capture, analyze and share lateral mainline grout and manhole surveys

- grout surveys are built in, no costly add-on
- track test pressure, joints passed or failed, and grout used
- backed by outstanding support and service

Call today for an online demo and more info.

866.299.3150

www.flexi-data.com

## flexidata

CAPTURE. ANALYZE. COLLABORATE.



Trademarks provided under license from ESRI.

## KEN-WAY Beats the Others DAY-IN • DAY-OUT

And they have for over 50 years

### KEN-WAY CABLE CLEANERS

for cleaning sewer, drain or process lines from one to ten inches, up to 75 feet with the Junior and up to a full length of 300 feet with the Model 400



### KEN-WAY Exclusive Built Cables

3/8" 13/32" 1/2" 3/4" 11/16" 5/8" 5/16" 1/4"

- Heat Treated
- Inner-Core or Non-Core
- Fit Most Other Brands
- Interchangeable with Most Brands
- Coupling or Blade Holding Types



Leasing plans available. Call for details.

1-800-533-0551

930 ROBERTS ROAD, SPARTA, WI 54656  
www.ken-way.com • E-mail: info@ken-way.com



# ALL THE TOOLS OF THE TRADE. FROM ONE SOURCE.

## AQUATECH

COMBINATION MACHINES ENGINEERED & BUILT AROUND THE OPERATOR.



## O'BRIEN®

JETTERS THAT PAY FOR THEMSELVES. AGAIN, AND AGAIN, AND AGAIN.



## ultraVac®

THE NEW POWER IN HIGH VACUUM LOADERS.



## X-vac®

VACUUM EXCAVATORS. THINK OF THEM AS SURGICAL INSTRUMENTS.



When you invest in any of the Hi-Vac Corporation Brands, you are getting "The most value for your money". They are designed to be the easiest to operate. Cost less to maintain. And, are built tough to withstand the test of time.

# Hi-Vac®

HI-VAC® CORPORATION

740-374-2306  
USA 800-752-2400  
FAX: 740-374-5447  
hi-vac.com



## FROM LATERALS TO MAINLINES TO STORM DRAINS...

There's so much more you can do when your crews are running RST systems.

- Interchangeable cameras, tractors and crawlers to perform fast, accurate inspections in lines 4" to 200" in diameter and up to 3,000 feet in length
- Cameras feature high intensity white LED lights
- 40:1 Zoom with automatic iris and focus available
- Portable, truck and trailer mount configurations



GET MORE. DO MORE. RST.

Call today for more info about our custom-fit inspection tools for municipalities and sewer service contractors.

VEHICLES | CAMERA SYSTEMS | SOFTWARE

800 767 1974

www.rstechserv.com

**RS** Technical Services Inc.  
Design and Manufacture of Video Pipeline Inspection Systems

This Is The Nozzle You've Been Waiting For

# Patented Root Rat

MADE IN THE USA

## root cutter nozzle



**1/2"** 7-35 gpm/1500-10,000 psi

**3/4-1"** 40-160 gpm/1500-4000 psi



**3/8"** 3-10 gpm/2000-7500 psi

"The Root Rat is the easiest and most versatile root cutter nozzle I have ever used. The Root Rat works where other nozzles fail."

Tim Jones, owner  
of Eastern Sewer Jetting

"I specialize in root extraction and own 2 sizes of Root Rats and have found them to be superior in performance. I am happy to recommend the Root Rats to anyone who cleans drains."

Jeff, Jasco Inc



### Chempure's Hot Box

This Hot Box turns a cold water jetter into a hot water jetter to de-ice, to dissolve grease, etc. depending on the flow rate it can heat the water up to 185° F.

### Custom Built Jetters

Hot or cold water jetters from 4gpm at 4000psi to 12gpm at 4000psi, skid or cart frames or small trailer systems.



### Root Rat Combo Kit

3/4 - 1 inch root rat combo kit. Use a reducer adapter to go from 1 inch to 3/4 inch.

"I bought the 3/8" Root Rat combo kit to use on my 4 gal at 3000 psi jetter, I cleaned out 100 ft of roots in a drain, WOW what a nozzle thanks to you and your company for a great product."

K.W., Mile High S&D Co

- WE SELL AND SERVICE COLD WATER JETTERS •
- WE SELL PARTS, PUMPS, UNLOADERS, HOSES, JET TIPS, ETC. •

**CHEMPURE PRODUCTS INC.**

1-800-288-7873 • 330.874.4300

www.chempure.com

Visa, Mastercard, Discover, Amx Accepted

# VAPOROOTER®

The **MOST** Effective  
Root Control

Municipal  
Contractors

Residential  
Contractors

1968



2008

Chemical root control is one of the fastest growing municipal sewer services

- Added service for existing customers
- Sales and technical support
- Jet-truck or trailer mounted units available
- 4-5 times faster than cleaning
- Revenue 2-3 times higher than cleaning
- Generate \$4000+ per unit per day

(800) 841-1444

For your FREE info pack  
TODAY!

info@VAPOROOTER.com



The best root control product is now available for residential applicators

- Ground floor opportunity
- Low investment with financing available
- Exclusive territory
- Annual treatment programs
- Much faster and easier than rooting
- Generate \$1000+ per unit per day

(800) 781-3164

For your FREE info pack  
TODAY!

info@VAPOROOTER.com

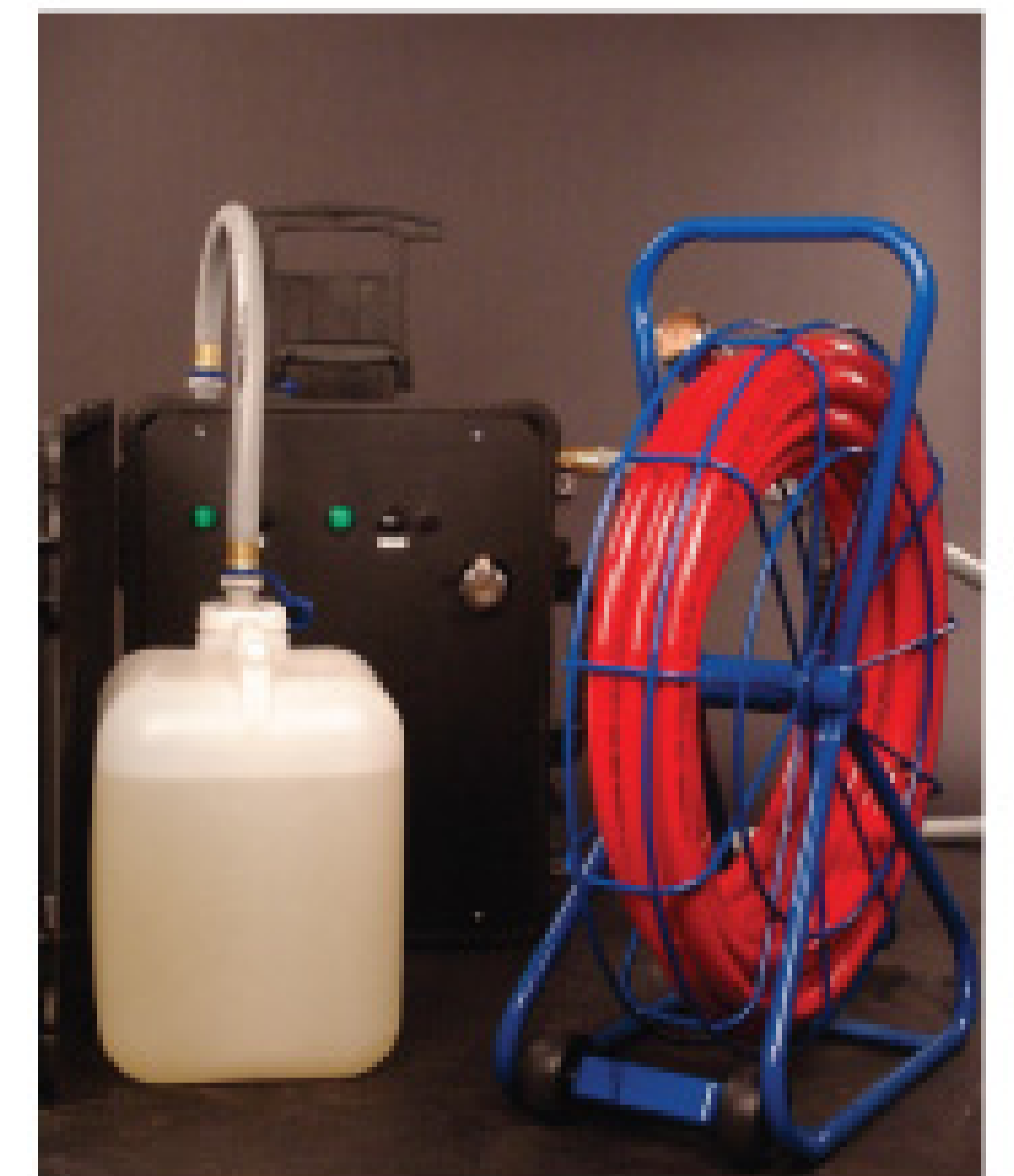

VAPOROOTER® pioneered chemical root control in 1968 and remains the most effective chemical root control product on the market today.

VAPOROOTER® is guaranteed to kill roots on contact and prevent growth for up to three years following application.

WWW.VAPOROOTER®.com



David Currier Jr.

# Fear Gets Lapped

An industry contractor relocates his business and family to help his son pursue a promising career as a stock car race driver

By Ted J. Rulseh

Someday, David Currier Jr. hopes to drive a race car bearing the emblems of brands like Mountain Dew, Craftsman, and The Home Depot.

Right now, he's happy driving on a late-model circuit in a Chevy Monte Carlo with sponsors that include Cape Cod Biochemical Co. and Lake Norman Sewer & Septic Service — his father's business.

David Currier Sr. used to own and operate Currier Septic & Drain Service in Middleton, Mass. He moved the family to Denver, N.C., in August 2006 and started a new business so that David Jr. could be closer to the world of racing, for which he had a special talent since he started

in quarter midget cars at age 7.

Currier admits it was difficult — and tough on the family — to move across several state lines to help one son pursue a dream. He had to sell his business and start over. He and his wife, Cindy, had to leave good friends and a community they enjoyed. The three kids had to adjust to new surroundings and new schools.

Still, there are no regrets. Currier's new business is growing fast, and young David is moving up the ranks on the stock car circuit. "I've always been pretty good at shooting from the hip," the elder Currier says. "I've never been afraid to try things. I knew that if I put my mind to it, and had enough time, I could make it work."

## Pulling stakes

The family actually moved twice to land in North Carolina, in a small town near Mooresville, known as Race City, USA, and home base for numerous top NASCAR teams. Currier

**"I've always been pretty good at shooting from the hip. I've never been afraid to try things. I knew that if I put my mind to it, and had enough time, I could make it work."**

David Currier Sr.

Septic & Drain had 12 employees at the time Currier sold it.

David Jr. excelled as a driver almost from the first time he took the wheel. His brother Dennis, two years younger, also raced midget cars for a few years, until age 10. Currier took them on racing trips as far as Colorado. In time, he felt guilty being away so often and leaving his parents, Dennis and Carolyn Currier, in charge of the business.

In 2000, Wind River Environmental, the large septic system service firm in Hudson, Mass, made an offer for the business. It was attractive enough so that Currier could use some of the sale proceeds to help his parents retire. He worked for Wind River for two years, then moved the family to Swanzey, N.H., so that David Jr. could race on tracks

David Currier Jr. hopes to someday race with NASCAR's elite, but if his career doesn't take off, he plans to become a plumber. Currier currently drives the No. 3 late model for car owner Gary Hargett (left), who helped launch the career of the late Dale Earnhardt. (Photos courtesy of David Currier Sr.)

in the area.

"He wasn't old enough to race on the NASCAR sanctioned tracks near Middleton, so we decided to get him established on the non-sanctioned tracks in New Hampshire," Currier says.

In Swanzey, he spent three years building up a used-car business. The move was difficult for the kids. "The boys adapted pretty easily, but it was a lot tougher for our daughter Katie (then 14)," Currier says.

In Middleton, the family lived in an upscale suburban neighborhood. Swanzey was a smaller community of working people. "Back in Massachusetts, you could have any food you wanted delivered to the house," Cindy Currier observes. "The mall was 10 minutes away. In Swanzey, the mall was an hour and 15 minutes."

## Powering up

David Jr. kept progressing, racing both cars and motocross bikes. In 2005, at age 15, in his first season driving a full-size car in the mini-stock division on the 3/8-mile paved oval at Canaan, N.H., he won the track championship and was named rookie of the year. The next year he wanted to move up to late models, so his father took him to FinishLine Racing School in Florida to work under instructor Mike Loescher, who has trained the likes of NASCAR champion Jeff Gordon.

"I told him, 'We don't have a lot of money, and I want to know if my son has talent before we try late models,'" says Currier. After three days of competition at the school, David finished atop a group of 14 drivers.

"I asked Mike at the end, 'What do you think?'" recalls Currier. "He told me, 'Your kid is loaded with talent.'"

Another top name in racing thought so too: NASCAR team owner Richard Childress had seen David Jr. race and called the Curriers to suggest they consider moving south, where he would have a better chance to advance his career. In August 2006, Currier sold the car lot and various properties, and the family moved to North Carolina.

Looking to re-establish himself in business as soon as possible, Currier bought a small firm that installed and repaired grinder pumps. By advertising in newspapers and telephone directories, making cold calls on plumbers for subcontract work, and earning a

good reputation by word-of-mouth, Currier built the business into a diversified sewer, drain and septic service. His team includes his father, employee John Grant, and David Jr. after school and on weekends when he's not racing or working on his car.

## Squarely on track

Last year, in his first season in North Carolina, David Jr. raced limited late models. He now drives the late-model circuit on the half-mile track at Concord Motorsports Park in Concord, N.C., where speeds can reach 140 mph. He also expects to run in a few United Auto Racing Association (UARA) events at bigger tracks.

He is on the team of Gary Hargett, who is legendary in racing circles for recognizing and developing talent. Hargett has been credited with helping the late Dale Earnhardt build his career.

Currier's first race at Concord, in March, was memorable. "We qualified mid-field, and we were running well, until two guys trashed each other and bounced off the wall in turn four," he says. "We were clear to miss the crash, but one of the cars that was at the top of the track let off the brakes and started rolling down the track and smashed into the right side of our car."

David Jr. returned to the track about 10 laps down after extensive repairs in the pits. "We got out there right in front of the leaders," he says. "I must have had about five car lengths on them before they were going to lap me, but I just pulled away from them. They weren't coming anywhere close to me."

David Jr. (web site [www.davidcurrierjr.com](http://www.davidcurrierjr.com)) is already planning his next steps up the racing ladder. He hopes to race full time on the UARA circuit next year, then move up to the Automobile Racing Club of

America (ARCA), a level below the NASCAR Nationwide series. His plan is to make the Nationwide Series by age 20. "He's opening a lot of eyes," the elder Currier says. "He's had wonderful opportunities to learn from some of the best people in the racing business. We're excited about his future."

## Building the business

Currier's own business future looks good, too, although the cost of David Jr.'s venture is sobering. He expects to spend \$60,000 to run local tracks for the 2008 season and \$150,000 for the bigger venues next year.

Fortunately, Currier chose a business he knows well in an area with high market potential and without excessive competition. "I bought the business at a good price, and I was able to start slow and feel my way around the community," Currier says. "Being a Yankee and having such a Northern accent, I was a little concerned about how people would accept me. But the people here are incredibly nice."

"Over time, I bought drain-cleaning machines, a waterjetter, a Terralift machine, and a vacuum truck. I already had a mini-excavator. The area has a lot of septic systems, a lot of grinder pumps, and a lot of city sewer."

"It hasn't been easy at all. It's been hard, and knew it would be hard. But what isn't? I've found that if you're always fair to people, if you treat customers like you want to be treated, if you give them the respect they deserve, you're going to have a good business. That's the way my parents always did it, and they taught me the same way."

"I'm hoping David's racing career can take off. If not, he has already said, 'Dad, I know this is a million-to-one shot. If I don't make it, I want to work with you, and I want to get my license to become a plumber.' He graduated from high school this spring, and his work uniform is already ordered." ■

## NO REGRETS

David and Cindy Currier are sure of one thing: No matter how David Jr.'s racing career turns out, they'll never have to wonder, "What if ..."

"I'm never going to look back and say, 'Man I wish I'd done that with my kids,'" David Currier says.

His wife adds, "I feel pretty much the same way. When Richard Childress called, I was the one who said, 'Hey, there's nothing really holding us down in New Hampshire, other than some properties and a business, and it's not like we can't sell them.'"

"Once we moved from Massachusetts to New Hampshire, it didn't frighten us to make a bigger move down here. I don't ever want to look back and say, 'Gee, I wish we had tried.' You talk to many people who say, 'I was really good at such-and-such, and I never went anywhere with it.'"

"Even if the racing never works out, we'll never have any regrets. We've adjusted down here. It's really nice. I love the area."

Currier advises other contractors who have a dream, for themselves or their children, to follow their heart. "If you can run a business and do a very good job at it, why can't you do that with your dream?" he says. "It's basically the same thing."

"David's racing is like running another business. It's a lot more competitive than any plumbing company, but it's still a business. I've run a couple of businesses at a time before. I've just never been afraid to do anything like that and I don't think anybody else should be, either."



At left, when not behind the wheel of a race car, David Currier Jr. works the controls of a backhoe for his father's sewer and septic business. Above, David Currier Jr. (from left) enjoys the support of his mother, Cindy; father, David Sr.; older sister, Katie, and younger brother, Dennis.

*After Hours is an occasional feature that describes how business owners reconcile work life with family, leisure time, charitable pursuits, and personal interests and passions. Cleaner welcomes story ideas. If you take part in something interesting outside work, or if you know someone in the cleaning business who does, please send a note to [editor@cleaner.com](mailto:editor@cleaner.com).*

**Speedway.**  
DRAIN CLEANING PRODUCTS

Speedway. Offers A Complete Product Line Of Contractor Tough, Plumber Approved Designs. You Can Count On Speedway. To Deliver Unmatched Performance & Value. For More Information And A 2008 Catalog, Call Or Visit Our Web Site 800-835-2200

[www.speedway-tools.com](http://www.speedway-tools.com)



Now With DVD



Selected Sales Territories Available. Interested reps please e-mail [dburritt@cobraus.com](mailto:dburritt@cobraus.com)

**Speedway.**  
DRAIN CLEANING PRODUCTS

The **Fastest Growing Name** In Drain Cleaning Machines

Introducing Lindhorst Nozzles

State of the art conical ceramic inserts

The All Star Kit is a complete self contained case featuring all the best nozzles available in each class. Arm your operators with a complete arsenal to deal with any potential line condition.

<b>LHD-38.16 Chisel Point</b> Use: Blockages of all types Features: • 8 Rear jets for maximum thrust to ram blockages • 4 forward jets to clear stubborn blockages • Aggressive chisel shape & tool steel blasts through obstructions	<b>LHD-10.16 Rotating Nozzle</b> Use: Cleaning crowns, general cleanup of newer installations Features: • High speed spinning barrel scours crowns effectively • Excellent cleanup of newer lines plus PVC • Right angled cleaning jets direct maximum force to the pipe wall to tear away grime	<b>LHD-40.16 Partial Nozzle</b> Use: Every day workhorse Features: • 8 rearward dual angled jets for optimal coverage & cleaning power on the pipe wall • Optional forward jet allows for forward cleaning (shipped plugged)	<b>LHD-20.16 Grenade</b> Use: Main Line Cleaning especially larger lines Features: • 10 rearward dual angle jets maximize cleaning & minimize streaking • Massive 3"x6" size for stability in larger lines • Aggressive jet design creates exceptional vortex vacuum action for maximum finish cleaning	<b>LHD-60.16 Torpedo</b> Use: Long pulls and hills Features: • Aluminum lightweight body maximizes velocity • Used for difficult long runs & hills, this is the ultimate pulling nozzle • Low cost hardened steel insert design

Introducing The Best In German Engineering And American Design

**LINDHORST WORKHORSE NOZZLES**

Conical ceramic inserts hold their dimension longer, directing maximum energy at the wall of the pipe. Debris explodes on contact. The finest German tool steel and high quality finish, maximize your horsepower!



**702.324.2244**

[www.Lindhorstnozzles.com](http://www.Lindhorstnozzles.com)

Dealer inquiries invited.

Have you seen the **Cleaner E-Zine?**



Go to [cleaner.com](http://cleaner.com) to view the e-zine.



**Harben Service always has been, and always will be, SECOND TO NONE. As the Pioneers of High Pressure Water Jetters, we offer the best knowledge and experience in the industry. Call us today for your parts and service needs.**  
**1-800-327-5387**



**MARSHALL HOLCOMB**  
Pump Specialist:  
Over 27 Years Pump  
and service experience.



**TED ENGLE**  
Inside Sales Manager:  
Over 10 Years of quality  
customer service and  
dedication.



**BYRON GARMON**  
Parts Manager:  
Over 5 Years of parts  
and service experience.

# RAUSCH Equipment for Top Performance!

## Lateral Inspection & Lateral Jetting - From the Mainline!!

The most unique combination in the business!

For more information visit our website at [www.rauschtv-usa.com](http://www.rauschtv-usa.com).

### MAINLINE & LATERAL INSPECTION



Tractor SAT200 and Cameras SK200Z and KS60

WANT TO BE A DEALER?  
CONTACT US FOR DETAILS!

### LATERAL JETTING

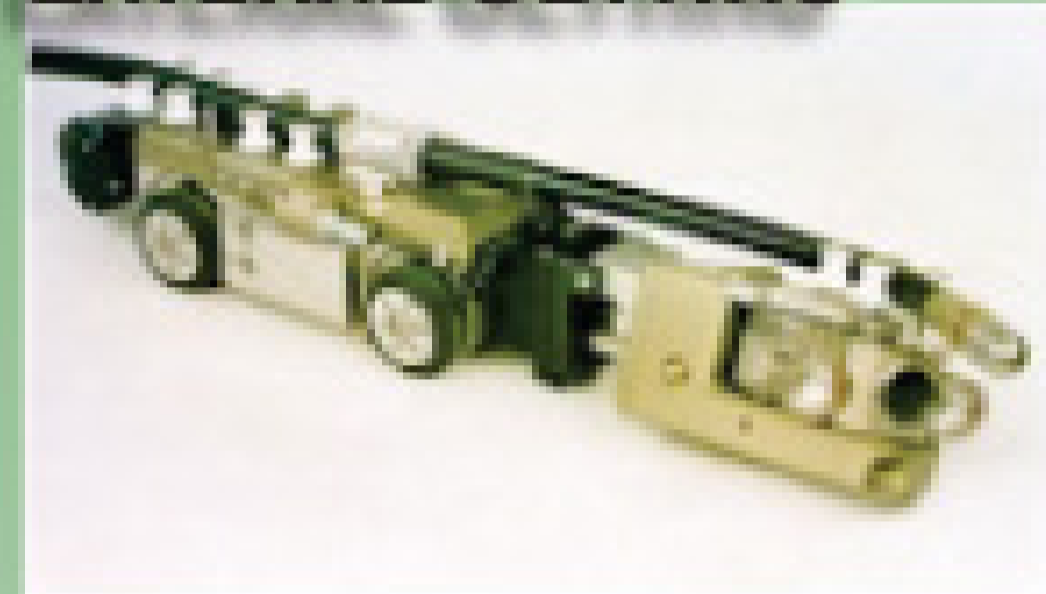

TSS 200 Lateral Flushing System

- Mainline & Lateral Inspection
- Lateral Jetting
- Point Repair
- Pressure Testing
- Profiling

RAUSCH Electronics USA, LLC (REUSA)

370 New York Avenue  
Chambersburg, PA 17201  
Email: [reusa@rauschtv.com](mailto:reusa@rauschtv.com)

Call (877) 728-7241



Rental and Leasing Services Available!  
Call Today!

Call For  
FREE DVD



Lumberjack™

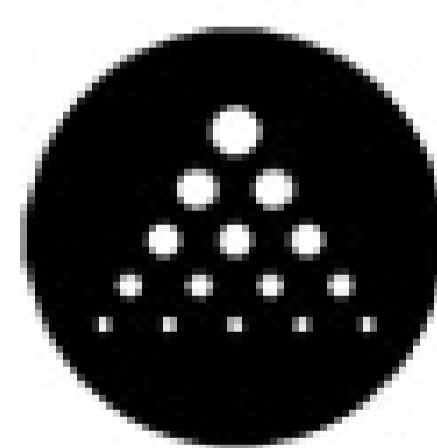

**NozzTek™**

Taking Science to the Sewer!™

Equipment Engineered for  
Long Lasting Performance.™

Phone: 1.866.620.5915 Fax: 603.413.6744 [www.nozztek.com](http://www.nozztek.com)

# JOIN THE DISCUSSION!

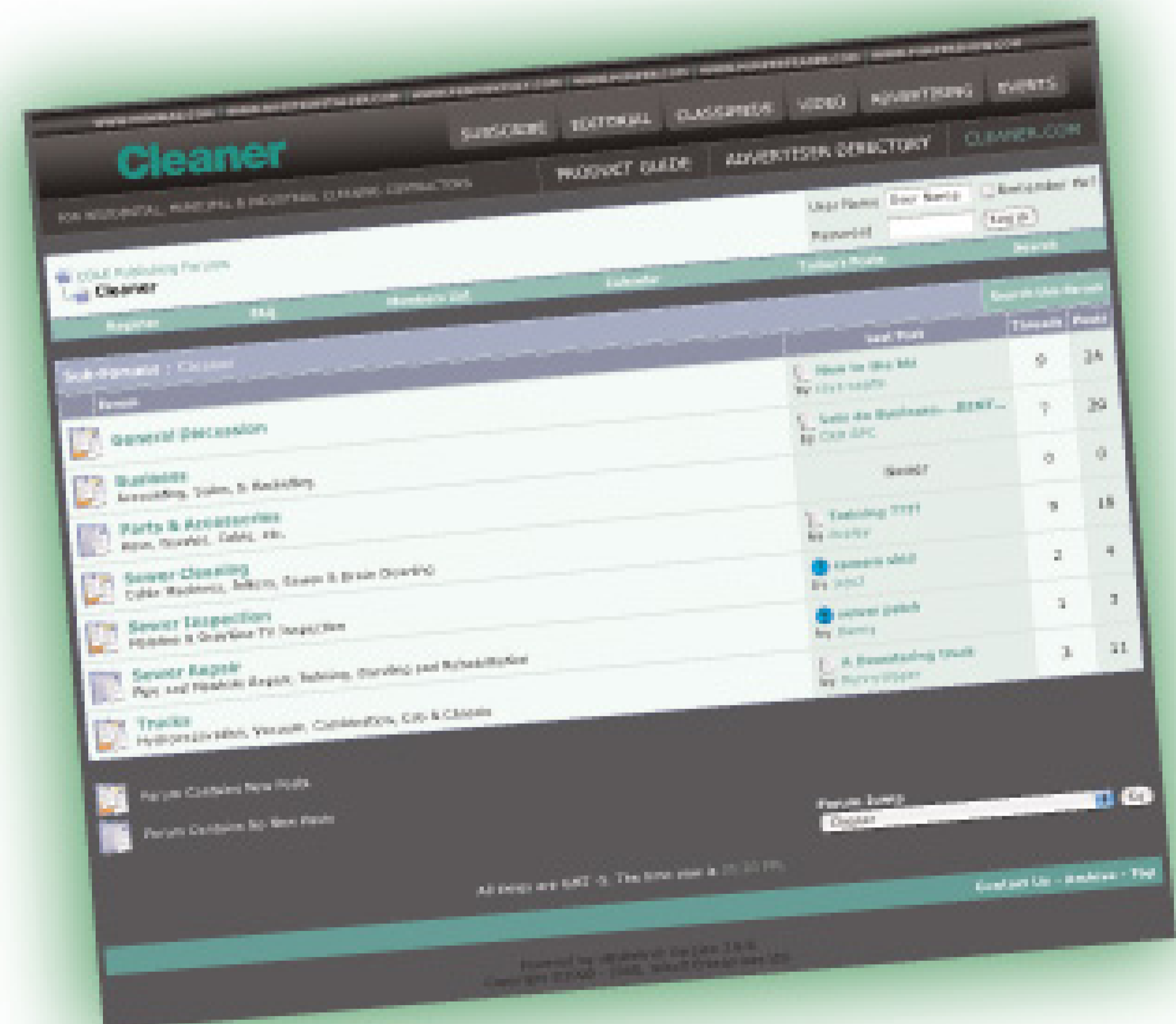

**Cleaner Discussion Forum** is a FREE online based forum for industry professionals to swap information and ideas on topics related to the residential, municipal and industrial cleaning industry.

Sign up today at [www.cleaner.com](http://www.cleaner.com)



# PROBLEMS FINDING LEAKS?

In Sewer Systems...

...In Plumbing Systems

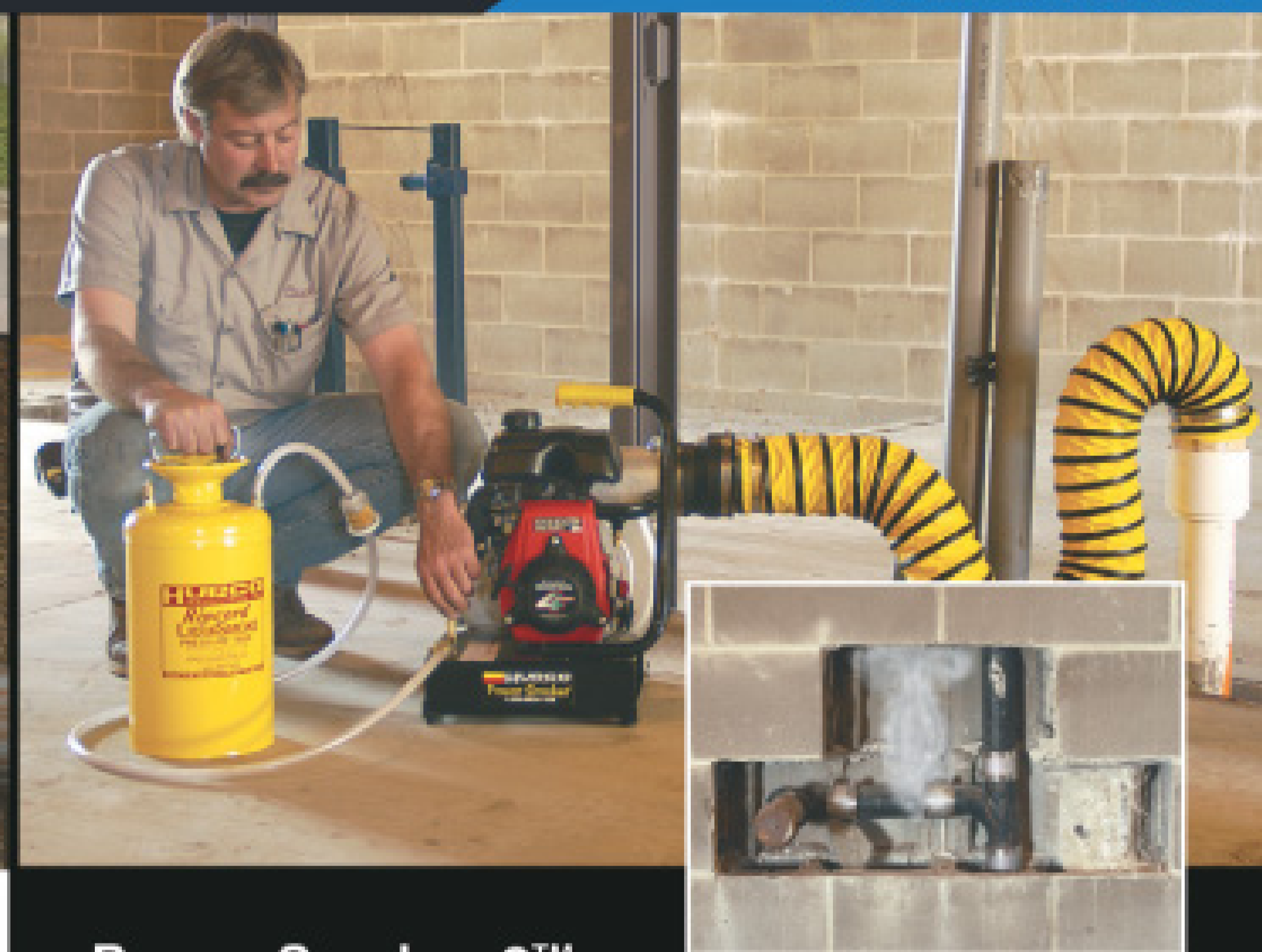

Not anymore with the world's most complete smoketesting systems.

### Original RipCord Smoker™ Features:

- More minutes of smoke flow per gallon than any competitive model.
- LiquiSmoke smoke fluid is the safest and cleanest way to test sewer lines.
- Most complete public service announcement kit and data collection software.



RIPCORD Smoker™

### LiquiSmoke™

- Laboratory tested safe, does not contain toxic compounds like "zinc chloride".
- Won't stain or leave odors.
- One gallon will last up to 3 hours.

### Power Smoker 2™

- Plumbers—finds leaks and odor problems in plumbing systems fast and economically.
- Contractors—avoid costly ripouts. Find the leak before the job is done.

### SuperJet™

- High Performance Smoke Generating Systems
- Standard on all HURCO "Smoker" systems
- Patented design creates 3 times more minutes of smoke than competitive models.
- Super efficient. Atomizes LiquiSmoke™ resulting in a nearly 100% burn.



PowerSmoker 2™

For a video demonstration and complete laboratory test results of HURCO's Smoketesting Systems go to [www.GetHURCO.com](http://www.GetHURCO.com).

**HURCO**  
TECHNOLOGIES, INC.

See how it works at  
*Get* **HURCO.com**  
or call  
**1-800-888-1436**

# The Ideal Vehicle

**Contracting professionals share thoughts on service trucks that deliver convenience, efficiency, comfort, and affordable cost**

This feature in *Cleaner* reports noteworthy conversations that take place in *Cleaner Discussion*, an e-mail based forum for industry professionals sponsored by COLE Publishing. *Cleaner Discussion* provides for the exchange of information and ideas on pipe cleaning rehabilitation and maintenance, trucks and equipment, high-pressure cleaning, business improvement topics, and much more. To find out more about *Cleaner Discussion*, or to subscribe, visit [www.cleaner.com](http://www.cleaner.com).

## Question:

We have been in the business for a long time, but we're still trying to find the right service truck for drain cleaning — easy to load and unload, room for tools, cameras and locators, comfortable seat, decent fuel mileage. No vans, please — we had three. You can't see out of them, the rodders get stinky inside in summer, and they are too expensive to insure compared to other vehicles. Any suggestions?

## Answers:

Have you considered a Chevy Express van?

It has the shape of a van, but the cargo space is separated from the cab area. There is a door that provides access from the cab to the cargo space. There are multiple compartments built into the exterior sides.



I use a small utility trailer, 6 feet wide by 10 feet long, and pull it with my truck. There is lots of room on the trailer for logos and phone numbers. It's low enough to the ground so that I can pull my mainline machine in without a winch or hoist, and I still have the option of unhooking the trailer and using my truck for other things.



The cargo van is hard to beat, since you can unload from side and rear doors without getting into the truck. I have been experimenting with a trailer for the machines I don't use often. The single-axle enclosed trailers usually don't have brakes. With two men in my 3/4-ton van, I'm dead on front and rear axle ratings (short wheel-base). I couldn't have done that without the side door to get some of the heavy stuff in and out.

Back to the trailer: I need brakes on it. For anybody who is considering what I'm doing, surge brakes are the way to go over electric. I want a side door and a fold-down rear that makes a ramp. Tandem axle, surge brakes, 6- by 10-foot box. Nobody makes a standard production trailer the way I want it.



I'm around plumbers with Dodge Sprinter vans. I don't recall if they have a side door. They are nice for more plumbing supplies, but they don't fit in tight places. ■

# Some things just work.



US Patent 6052906

FORM follows function, and some inventions display this better than others. For trenchless sewer lateral replacement, the tool of choice is on the right. TRIC Tools introduced lateral pipe bursting to America and the world, and we continue to make this business easier and more profitable for our users by building the lightest, simplest, and most reliable systems out there.

So if pipe bursting is on your list, stop digging.  
Get crackin' with TRIC!

**TRICTools**  
THE TRENCHLESS AUTHORITY

[www.trictools.com](http://www.trictools.com)  
888-883-8742



US Patent 6305880



**Serious Machines for a Serious Business**

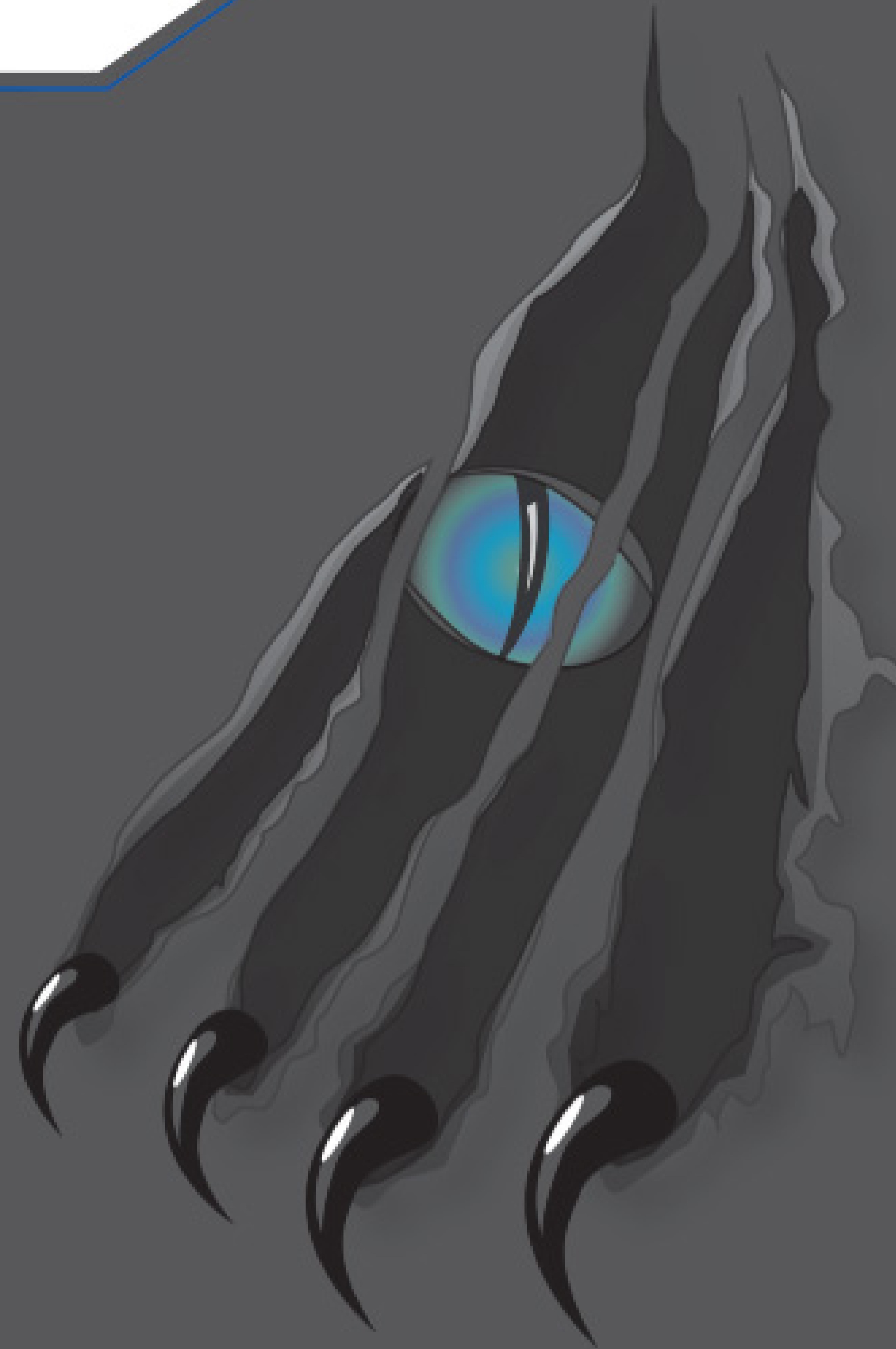

## **Mongoose Jetters, Shredding the Competition.**

### **RELIABILITY:**

- Cat<sup>®</sup> Diesel Engine.
- Weather Proof NEMA 4 Electrical System.

### **PRODUCTIVITY:**

- Full Function Wireless Remote.
- Rotating Reel Featuring Industrial Swivel Bearing.

### **BUILD:**

- Truck And Trailers Available In Both 300 and 600 Gallon.
- Custom Configurations To Fit Your Needs.



### **184XL TRUCK**

600 gallon, 18GPM@4,000PSI



### **184XL**

600 gallon, 18GPM@4,000PSI



### **184**

300 gallon, 18GPM@4,000PSI

[www.mongoosejettters.com](http://www.mongoosejettters.com)

1.877.JETTER1

**Changing** the way  
you **work**

# ENZ USA INC

STRONG, FAST AND ENGINEERED TO LAST!

## READY FOR ACTION!

### PUT A NEW SPIN ON LIFT STATION CLEANING!

- **ELIMINATES WASTEWATER DISPOSAL.**  
Emulsifying the grease allows the operator to pump the wastewater to a treatment plant.
- **FAST & EFFICIENT.**  
Just lower the nozzle into the wet well and reach all the spots you want to hit in a matter of minutes.
- **SCOURING FORCE & DEBRIS-FLUSHING.**  
Four radial rotating jets propel water, cleaning the walls, then act like a blender at the bottom liquefying grease chunks suitable for treatment.
- **5 models available to fit connections from 1/2" - 1-1/4"**



Golden Jet Radial RotoJet  
RGS Nozzle (Type 01.100A/LS)

**CALL 877-ENZUSA1 FOR  
(369-8721)  
A DEALER NEAR YOU**

ENZ USA INC. • 1585 Beverly Ct., Unit 115 • Aurora, IL 60502  
[www.enz.com](http://www.enz.com)

### NEW Website! NEW Machines! NEW ProClean Labels!

Inner Reel has a bronze bearing for consistent, smooth operation.

Ergonomic 3-Position adjustable handle with lanyard - works with your height!

Winch hook for easy loading and unloading.

Integrated, custom polyethylene tool box.

23" Polyethylene Reel is NOT used as a pulley, which reduces unnecessary wear on the bearings. Instead, the motor is Direct Gear Box Driven!!

Molded hand-holds for easy carrying.

The wheels are a high-density poly blend.

Our thick-walled, steel tube, welded frame is 33% stronger than the competitor's bolted frames.

# Duracable®

Manufacturing Company

**877-244-0556**

[www.duracable.com](http://www.duracable.com)

[sales@duracable.com](mailto:sales@duracable.com)

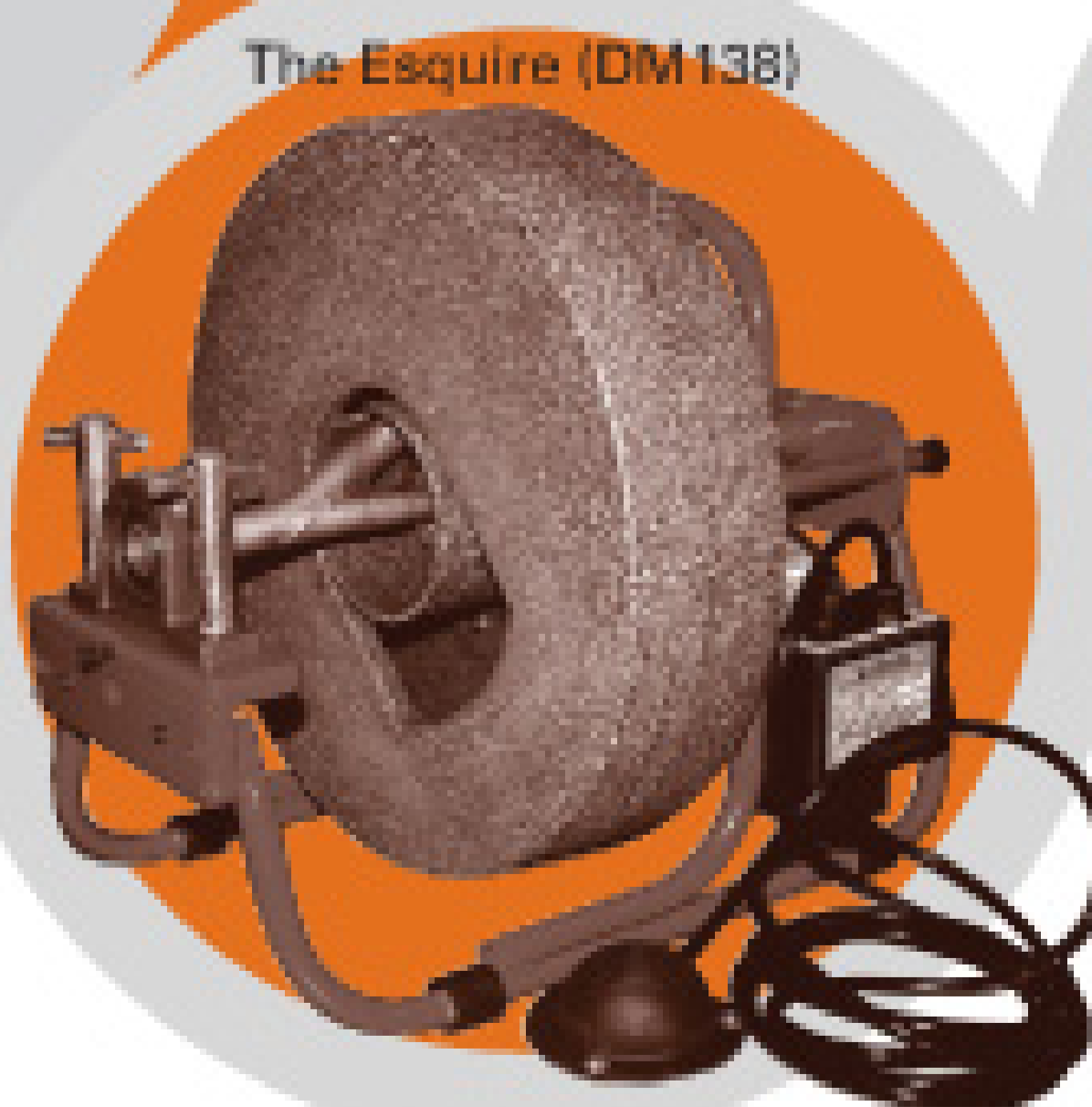

# "Simplify your life!"

SCOOTERS ARE EASY TO USE,  
TOUGH AND DEPENDABLE.  
DON'T LEAVE THE SHOP WITHOUT ONE.



**Prototek**  
Line Locating Tools - We  
Feature the Finest!



**COLOR**  
Video Inspection Systems  
Complete from **\$4,595**

**Black & White**  
Video Inspection Systems  
Complete from **\$3,295**

**FEATURES:**

- Diffuser lighting
- Flexrite gooseneck
- Quick change cameras
- Ultra tough pushrod
- Lightweight/compact
- Solid state lights
- One Year warranty

**OPTIONS:**

- Image inverters
- Voice over
- VCR/monitors
- Locators
- Carrying cases

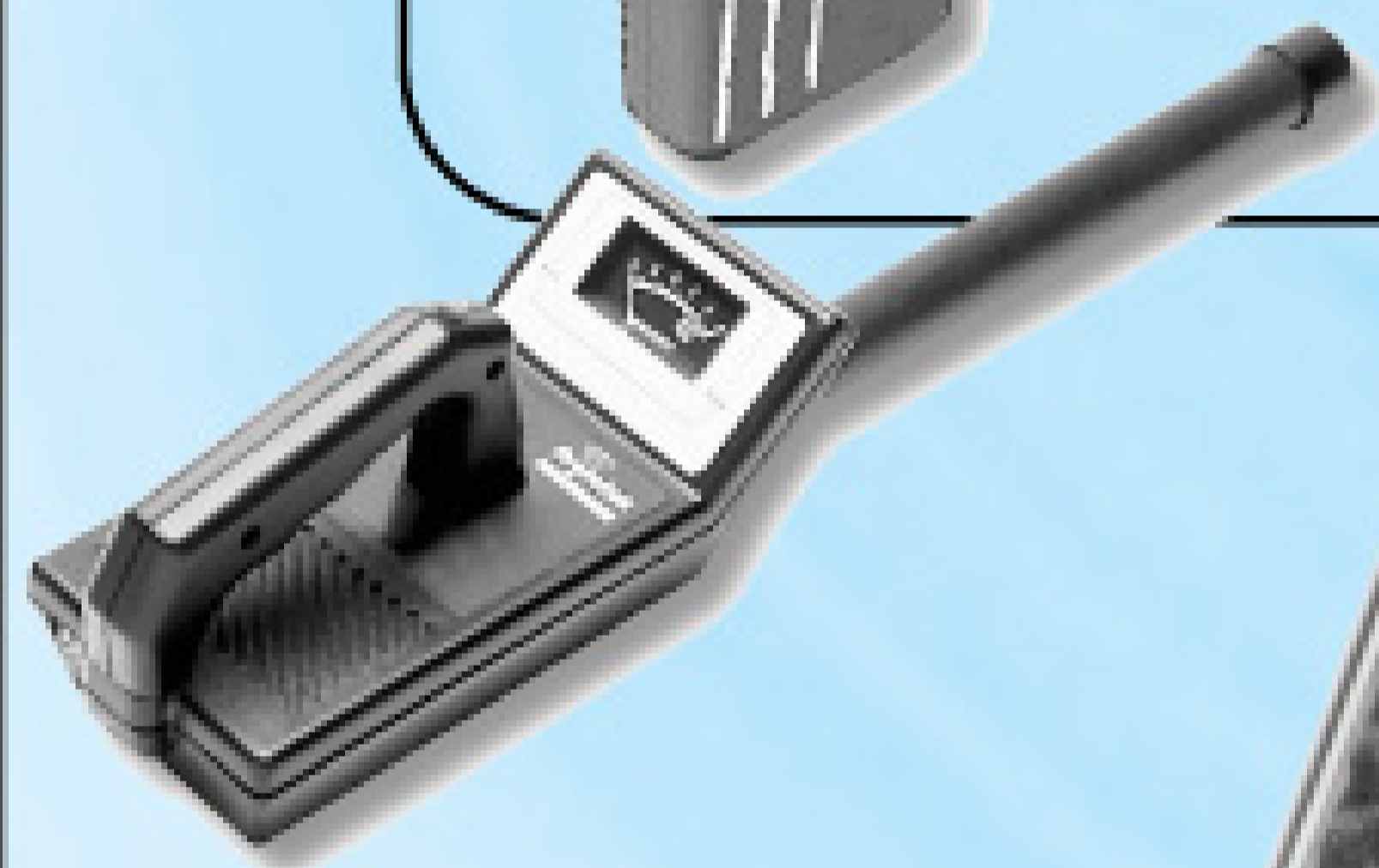

**Now  
with  
DVD!**

**The New Attaché Monitor**  
Lightweight & Compact!

VCR combo can be ordered with any Scooter system!



# SCOOTER

VIDEO  
INSPECTION SYSTEMS

20843 Santa Lucia • Tehachapi, CA 93561 • Fax: 661.822.8917

TM



800.772.6165 [www.tvinspection.com](http://www.tvinspection.com)

# No More Ping-Pong

A fleet of specially designed drain-cleaning trucks helps a Pennsylvania contractor keep its technicians productive and serve customers well

By Ken Wysocky

Several years ago, employees at Kline's Services Inc. in Salunga, Pa., felt more like ping-pong balls at times than drain-cleaning service technicians.

"Our vans couldn't carry everything we needed for a job," recalls Brad Brubaker, wastewater management specialist. "We'd dispatch a

and commercial line opening, industrial waste removal, and septic tank installation and service. While Brubaker can't quantify the trucks' financial impact on the business, he points out that the drain-cleaning division is now one of the most profitable in the company.

"We've increased the number of vehicles and technicians, and we're doing more work than we ever did before," he says. "We have five technicians, and we keep them on the road all day. These trucks are much more efficient. It's like having everything but the kitchen sink right in the back of the truck."

Three trucks carry Model 184 jettors from Mongoose Jettors, delivering 18 gpm at 4,000 psi. The others carry Model 4018 jettors from US Jetting Inc. that produce 15 gpm at 4,000 psi. Each truck also carries 3/8-, 1/4- and 5/8-inch cable machines from Duracable Manufacturing Co., as well as large and small SeeSnake cameras from RIDGID, says Shawn Perry, project manager.

Three of Kline's trucks carry Model 184 jettors from Mongoose Jettors, delivering 18 gpm at 4,000 psi. Others carry Model 4018 jettors from US Jetting Inc. that produce 15 gpm at 4,000 psi.

Kline's fashions its own shelving for the trucks, which are geared toward convenient access to the large, heavy, skid-mounted jettors. "The jettor sits at the very back of the truck," Perry says. "All the trucks are set up the same way — just open the tailgate and the jettor hose is right there."

## 'Those nice clean trucks'

The distinctive silver and red trucks, bearing the company logo and slogan — "Doing the Job Right!" — also serve as rolling billboards. "Our trucks are incredibly recognizable," Brubaker says. "They're

"Our trucks are incredibly recognizable. They're washed every day. They're spotless. We're known for our clean trucks. That helps us stand out, because there are a lot of beat-up trucks in this business."

Brad Brubaker

washed every day. They're spotless. We're known for our clean trucks.

## MONEY Machines

driver, and he'd arrive at the job only to find out he needed a jettor. Since the trucks couldn't carry a jettor, he'd have to drive back to the shop to pick one up, then drive back to the job. A technician could easily burn up an hour and a half in hours on the road."

Those days are long gone, thanks to a fleet of Mitsubishi FE180 trucks outfitted with 14-foot aluminum service truck bodies from Morgan Corp. Kline's owns five of the trucks, all designed specifically to carry jettor equipment.

### Doing more business

Kline's works in a 75-mile radius in Lancaster County in southeast Pennsylvania, offering residential

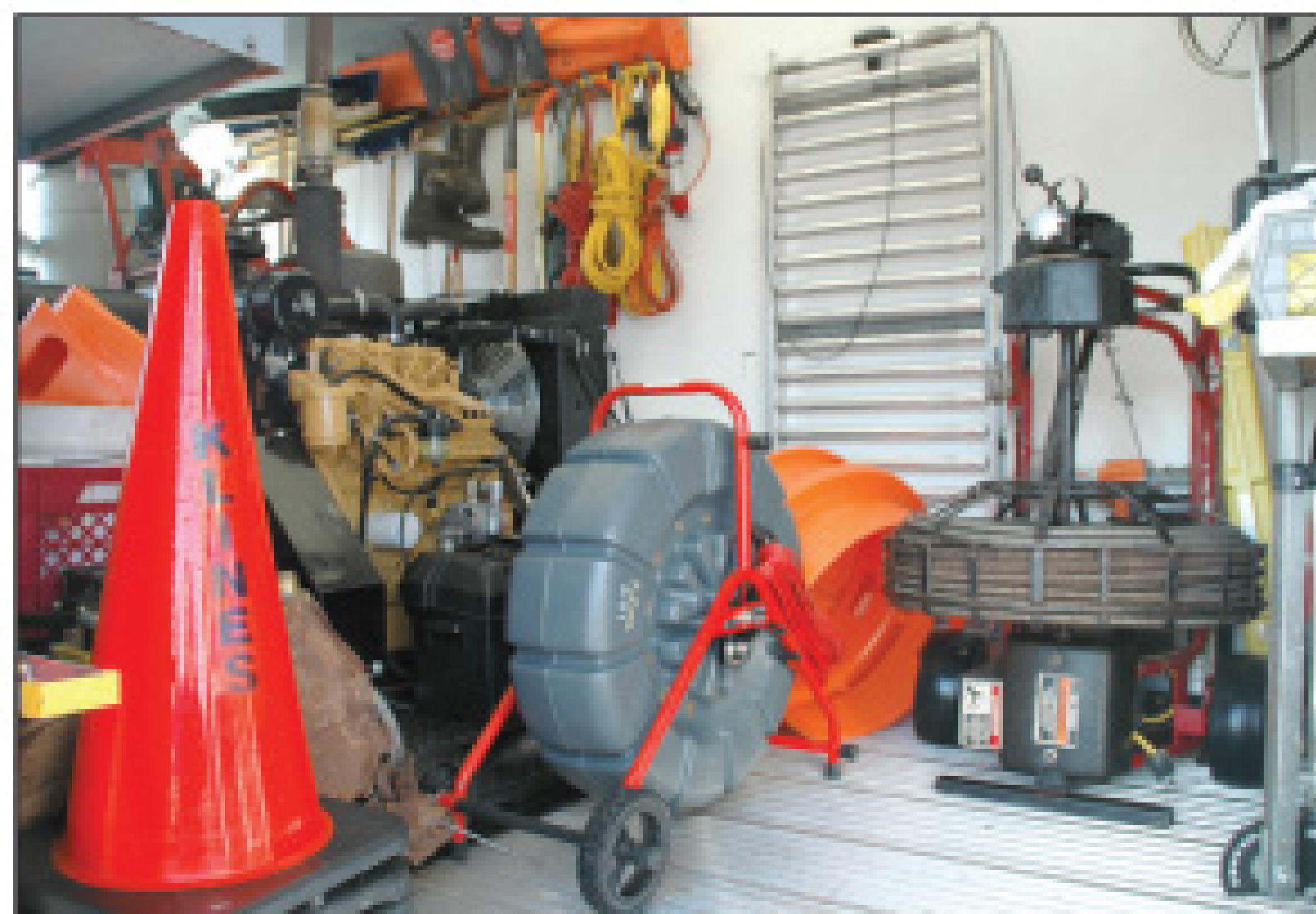

Each truck also carries 3/8-, 1/4- and 5/8-inch cable machines from Duracable Manufacturing Co., as well as large and small SeeSnake cameras from RIDGID.

## MONEY MACHINES

<b>OWNER:</b>	Kline's Services Inc., Salunga, Pa.
<b>FUNCTION:</b>	Transporting skid-mounted waterjetting and video inspection equipment
<b>VEHICLE TYPE:</b>	Mitsubishi FE180 chassis with 14-foot body from Morgan Corp.
<b>PRIMARY EQUIPMENT:</b>	Waterjettors from US Jetting Inc. and Mongoose Jettors; cable machines from Duracable Manufacturing Co.
<b>COST:</b>	About \$150,000 fully equipped
<b>WEB SITE:</b>	<a href="http://www.klinesservices.com">www.klinesservices.com</a>





Kline's fashions its own shelving for its trucks, which are geared toward convenient access to the skid-mounted jettors.

### SHOW US THE MONEY (MACHINE)

Money Machines, a new feature in *Cleaner*, reports on innovative work vehicles that help contractors operate more efficiently, satisfy customers, and earn more profit. We'd like to know about your Money Machine — be it a service van, camera truck, jetting rig, vacuum unit, or any vehicle that really helps drive your business. To nominate your vehicle for a feature in this column, send an e-mail to [editor@cleaner.com](mailto:editor@cleaner.com). Tell us briefly but specifically what features make it a great producer. And send a picture — because appearance counts. We look forward to seeing your Money Machine.

#### MORE INFO:

**Duracable Manufacturing Co.**

866/587-1597  
[www.duracable.com](http://www.duracable.com)

**Mongoose Jettors**

877/JETTER1  
[www.mongoosejettors.com](http://www.mongoosejettors.com)

**RIDGID**

800/769-7743  
[www.ridgid.com](http://www.ridgid.com)

**US Jetting LLC**

800/538-8464  
[www.usjetting.com](http://www.usjetting.com)

When people hear our company name, the standard response is, 'Oh, you're the guys who drive those nice clean trucks.'

"That helps us stand out, because there are a lot of beat-up trucks in this business. The message behind a clean truck is that we'll take care of a customer's property the same way we take care of our own equipment."

The trucks also display the company's web site and several phone numbers. "We cover a wide area, so we put several phone numbers on the truck," notes Brubaker. "Most people feel more comfortable calling a local number."

And those familiar trucks arrive at jobs a lot sooner, now that technicians no longer play ping-pong. ■

Each month you'll get

# Riveted to your seat

Dedicated to the Liquid Waste Industry. To receive *Cleaner* call us at 800.257.7222 or go to [www.cleaner.com](http://www.cleaner.com)

# Ramps

I should have used a Link® Ramp!



- Reduce Injury \$\$\$
- Reduces Dangerous Lifting
- Protect Your Equipment

**Do it RIGHT!**

**Link®**

Cargo Management Products

**1-800-248-3057**  
[www.linkcmp.com](http://www.linkcmp.com)



## "Black SHARK" Sewer Rods

5/16" x 39" – \$8.90 ea

3/8" x 39" – \$10.98 ea

Sold in Boxes of 50 pcs.  
 Call For Special Prices on 500 pcs. or More



P.O. Box 1338, Televast (Sarasota), Florida 34270-1338 USA

**Toll Free: 800-365-6583**

Phone: 941-739-0707 • Fax: 941-739-0001

[www.cloverleaftool.com](http://www.cloverleaftool.com)

# You Can't Buy A Better Reel.

## Hose Reels for Cleaning and Pumping

- ☑ High pressure washing and cleaning
- ☑ Sewer, septic, portable toilet cleaning
- ☑ Video pipeline inspection
- ☑ OE vehicles and aftermarket upgrades
- ☑ Extra rugged, long-lasting design
- ☑ Complete custom capabilities



Download or call for your FREE Guide to Ordering Pumper/Cleaner Reels  
<http://go.hannay.com/U15>  
 877-467-3357

 **Hannay Reels®**  
*The reel leader.*



# Liberty Financial

GROUP, INC.

For  
 Commercial Equipment  
 Lease Financing,

call

**888-883-4480**  
 Ask for Michael DeGroat

We put the **BLAST** in **BLASTer**.

(While maintaining Best-In-Class Fuel Economy.)

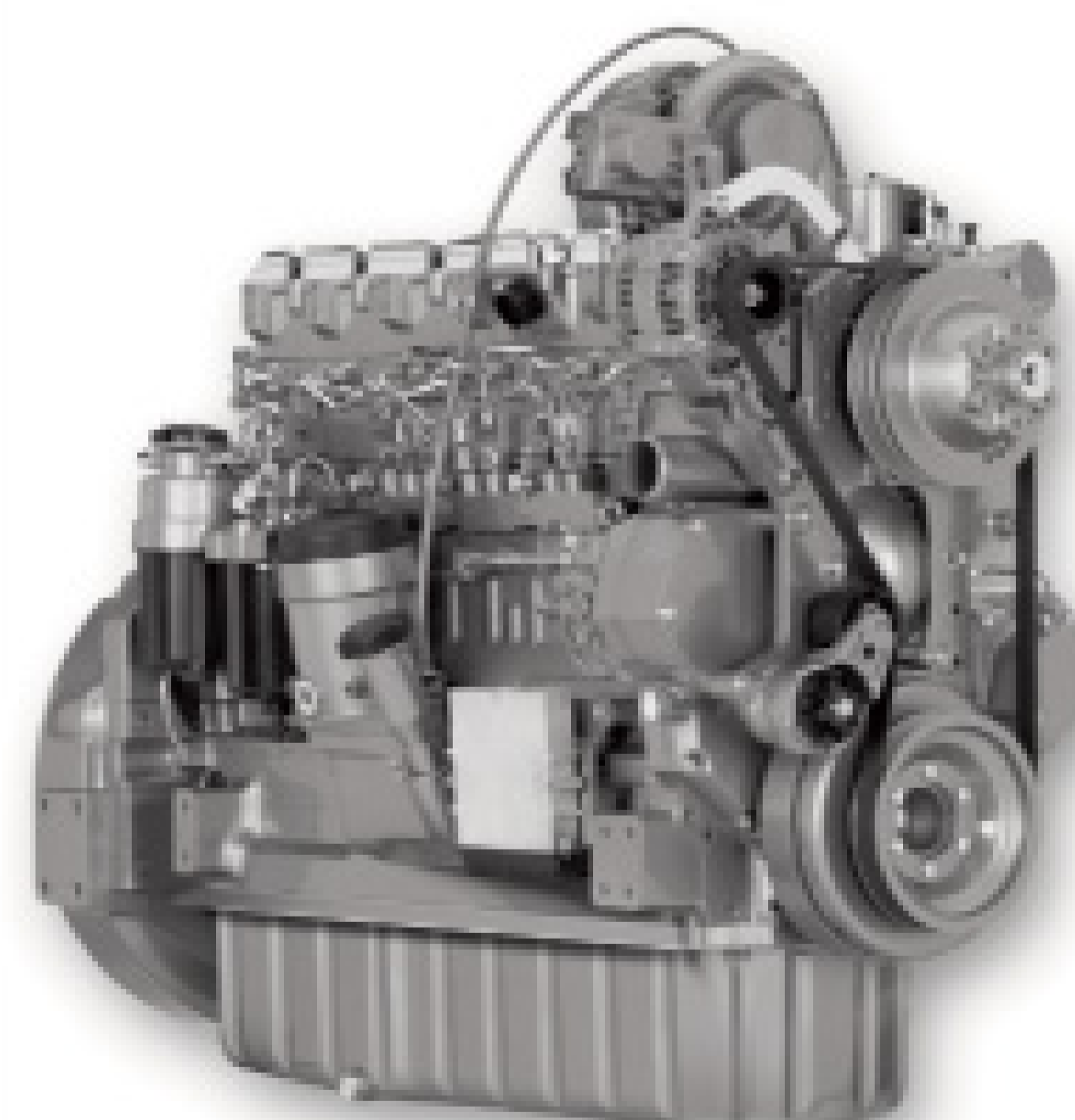

**Get more BLAST out of every tank.**

John Deere brings together several engine advancements in **PowerTech™ Plus engines** to deliver the highest possible performance and fuel economy. Don't settle for less.

**PowerTech™ Plus Diesel Engines** meet **Tier III** emissions without sacrificing performance. John Deere has maintained or increased power output from all **PowerTech™ Plus** models, from 49 to 600 horsepower. Powerful. High Performance. Fuel Efficient. Emissions Certified. Environmentally Smart.



  
**engines, inc.**  
 Reliability At Work

Conroe, TX      Jonesboro, AR  
 936-441-5592      800-562-8049

[www.enginespower.com](http://www.enginespower.com)

AUTHORIZED JOHN DEERE ENGINE DISTRIBUTOR

**A reliable source of power, a consistent source of confidence.**



Check Out What's New From the  
Industry Innovator for Over 75 Years

**SRECO**  
**FLEXIBLE**

**POWER**  
**CONTROL**  
**PRECISION**

SRECO Flexible...  
the equipment you need  
to tackle tough cleaning  
and maintenance jobs  
"inside" and "out"



## Versa Vac 1000 PD

**Precise, Clean and Quick Excavations**

Multi-tasking versatility is yours—easily clear debris from sanitary and storm sewer manholes, clean catch basins, safely uncover underground pipes or utility cables and more with the power, control and efficiency of the Versa Vac.

- ✓ 15 feet of vacuum pull depth
- ✓ 4 gpm / 3500 psi water pump
- ✓ 1,000 gallon debris tank
- ✓ 360° fully hydraulic boom
- ✓ wireless remote control
- ✓ retractable reel

## Bronco Trailer Jet

**Kicking Out Even More Productivity**

A powerful trailer-mounted jet system featuring high water pressure and GPM delivery at a budget friendly price.

- ✓ 20 gpm at 4000 psi
- ✓ 325 gallon water tank
- ✓ up to 600' of hose capacity
- ✓ integrated JetCam, LCD monitor and DVR
- ✓ articulating reel



Call today for more information about these products and our complete range of wastewater collection systems maintenance solutions.



**the right tools for the job**

Toll Free: 800.421.6536  
310.606.9009 local  
info@srecoflexible.com  
www.srecoflexible.com

# KMH EQUIPMENT COMPANY

SALES • RENTALS • SERVICE

KMH Equipment has many well maintained quality trucks and equipment for sale or for daily, weekly, or monthly rental. Financing Available

- Vacuum Trucks
- Combination Trucks
- Hydro Excavators
- Jetters
- DOT Certified Trucks
- Sweepers

**PRESVAC**



**VACALL**™

**Phone 1.888.KMH.0202**

**[www.kmhequip.com](http://www.kmhequip.com)**

# VACTOR

Subsidiary of Federal Signal Corporation

**Genuine OEM Performance  
Matched to Vactor Trucks**



**If you own a Vactor - trust a Vactor Nozzle  
to bring out the best in performance**



815.672.3171 or [www.vactor.com](http://www.vactor.com)

Made in the U.S.A. • Custom designed nozzles available

**SOFTWARE FOR THE INDUSTRY**



**GET A LIFE!**

*...with software that will get your life back!*

**Summit™ XP Service Profit Builder™**

Work Orders  
Job History  
Reminders  
Diagrams  
Dispatching  
Instant Mapping  
Inventory Control  
Receivables  
Commissions  
Repeat Business  
QuickBooks® Link  
...and much more!

**Easiest to use!**  
**...Over 25 years  
experience**

*Let us transfer the data  
from your old program!*  
**Stay on Top...with Summit™!**

*Ask about our other software programs for:*

- Portable restrooms & other rental businesses
- Sales contacts for sales personnel
- Employee incentive tracking
- Fleet maintenance and service tracking

**DEMOS ON LINE!...or call for a Demo DVD or personal guided tour**



**Ritam Technologies, LP**

Sales: USA 800-662-8471 • Int'l: 208-629-4462

Email: [info@ritam.com](mailto:info@ritam.com) • Web: [www.ritam.com](http://www.ritam.com)

**It's easy to be cheaper. It's harder to be better!**

***OLDEST NAME IN THE BUSINESS***  
***— Over 100 YEARS OLD —***



**NEW**  
**SeekTech®**  
**SR-60**

**NOW**  
**AVAILABLE**

*RIDGID's new line of locating equipment meets the most demanding needs of the locating professional. Built to make even difficult locates easy, SeekTech is the only line locator that uses omni-directional antennas, guidance arrows and an easy to read mapping display to lead you quickly and accurately to the target line.*

**Parts & Service**

**Having Trouble**

**Finding**

**RIDGID Parts?**

**We Have**

**RIDGID Parts!**

**RIDGID®**

**THE BEST SERVICE AT PRICES TOO LOW TO LIST!**

**RIDGID®**



**SeeSnake**

**ALL SeeSnakes  
NOW INCLUDE 512 HZ  
TRANSMITTERS**

**DVD NOW  
AVAILABLE  
ON SEESNAKE  
IN-STOCK**

**Factory Repair  
for SeeSnake**



**SPECIAL PRICES ON THE NEW RIDGID SCOUT® IN STOCK!**

**Allan J. Coleman Co., Since 1905 - CALL US TODAY! 773-728-2400**

**"THESE PRODUCTS ARE SO GOOD, WE GIVE YOU OUR ADDRESS!"**

5725 North Ravenswood Avenue • Chicago, IL 60660 • [www.allanjcoleman.com](http://www.allanjcoleman.com)

**PHCC MEMBER**

# Your Waterblast Specialists

Visit [www.stoneagetools.com](http://www.stoneagetools.com) for :



Surface Prep  
15k, 20k, 40k psi



All Sizes  
of Pipes



- **Complete Product Catalog**

Download the latest info on all of our tools

- **Information Center**

Industry Leading Research Papers

- **Access Literature**

Catalogs, Flyers, & Newsletters

- **Specialty Products**

Unique Solutions for Difficult Applications



Exchangers and  
Tube Lancing

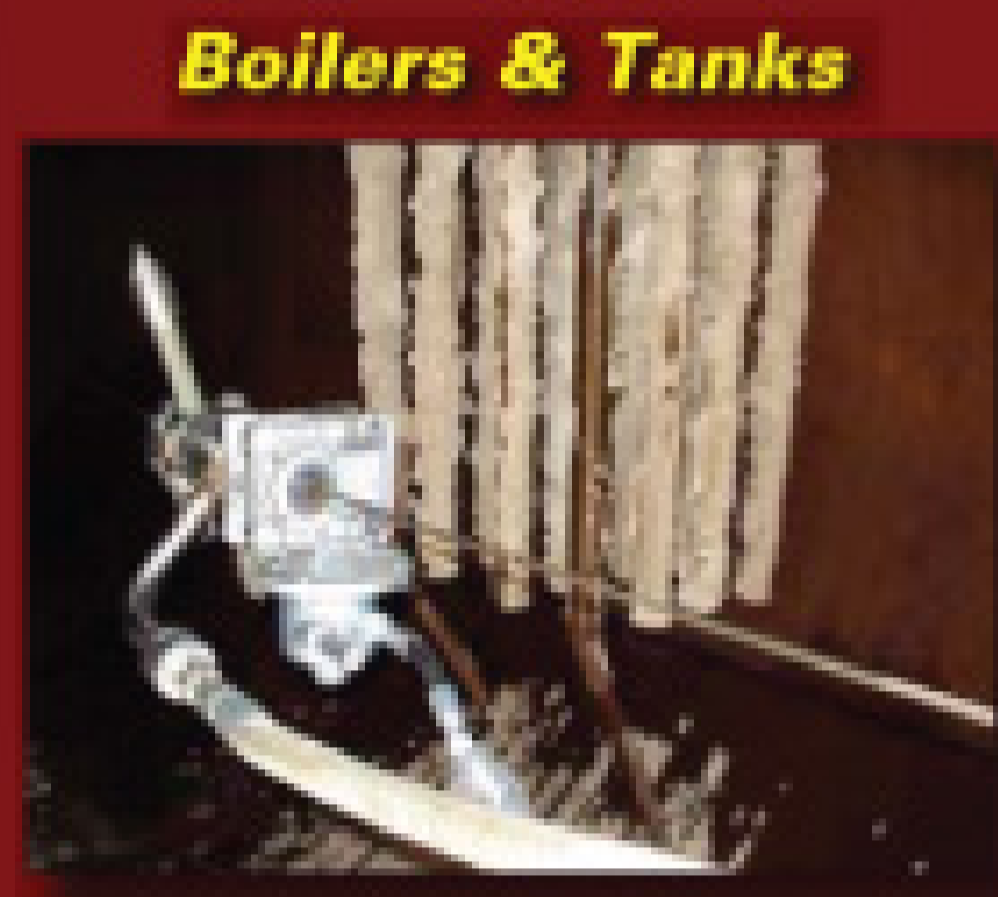

Boilers & Tanks



Rotary Couplings  
2k - 40k psi

While at our site  
check out the  
new Banshee tube  
cleaner!



P. (970) 259-2869 F. (970) -259-2868

## FRUITLAND offers quality

### SEALED WORM GEAR DRIVEN BEARINGS

Complete with **HYDRAULIC MOTORS!**



Sealed Boom Swivel Bearing driven by  
WORM GEAR and hydraulic Motor.

In addition to many sizes and types of Boom Swivel Bearings from 4" to 17" with and without Gears, we will custom design to your specifications!

We have **Replacement  
Hose Reel Bearings**  
for most makes



## FRUITLAND TOOL & MANUFACTURING

324 Leaside Ave., Stoney Creek, Ontario L8E 2N7 Canada - Tel: (905) 662-6552 - Fax: (905) 662-5412  
Toll-Free from the U.S.A. and Canada: 800-663-9003

# \$ WE'VE GOT THE MONEY \$

## For All Your New and Used Equipment Needs

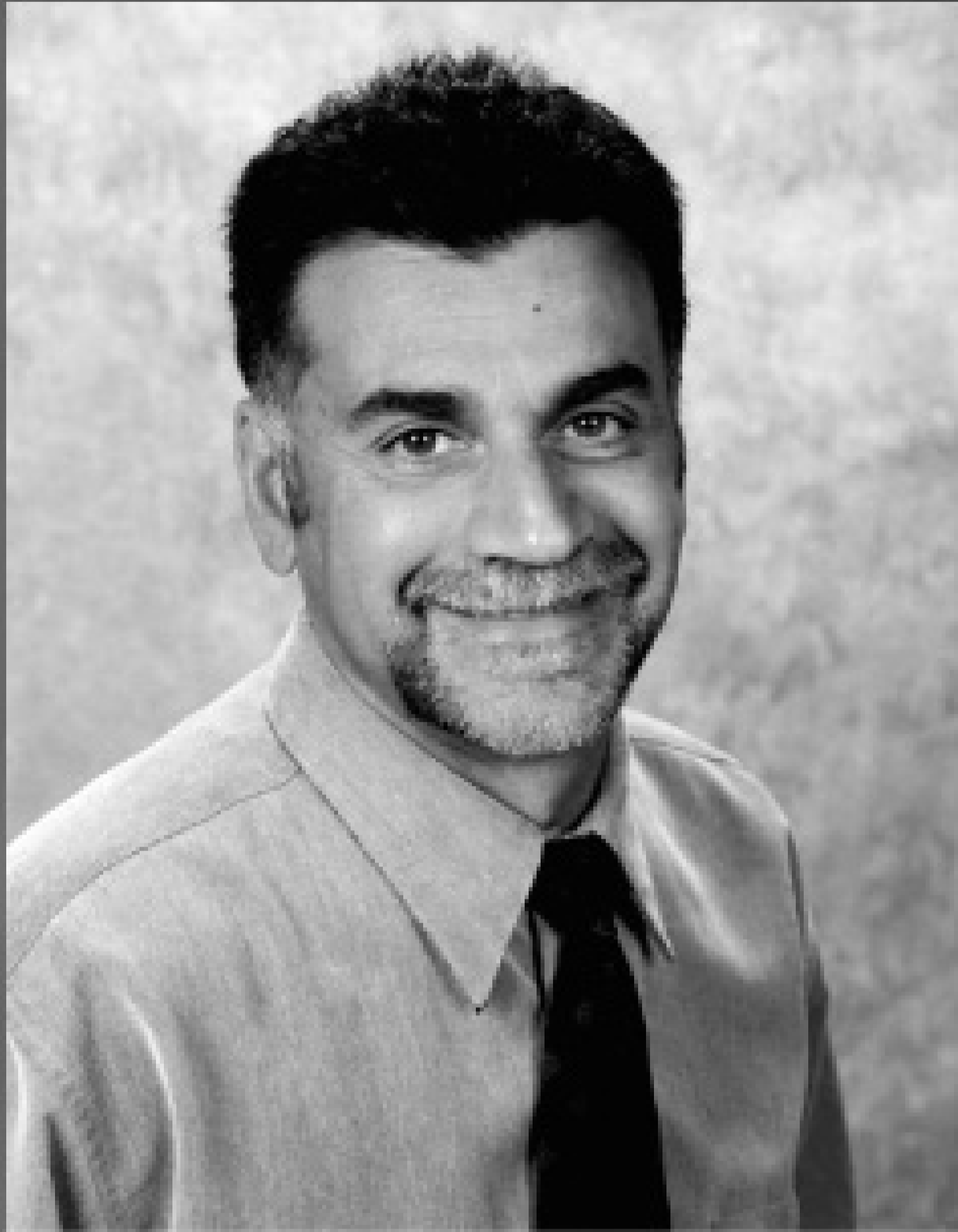

**CHUCK TERRITO**

- > APPLICATION ONLY TO 250K
- > SIMPLE APPROVAL PROCESS
- > LEASE OR LOAN OPTIONS
- > NEW & USED EQUIPMENT
- > FLEXIBLE FINANCE OPTIONS
- > START UP PROGRAMS



**MIKE RAUSCH**

Fax this E-Z application to **406.892.5072**, or give us a call, and we will get your financing approved for the show.

Company Name: \_\_\_\_\_ Owner/Contact: \_\_\_\_\_

Address: \_\_\_\_\_

City: \_\_\_\_\_ State: \_\_\_\_\_ Zip: \_\_\_\_\_

Phone: \_\_\_\_\_ Best time to call: \_\_\_\_\_

**Let us put our 35 years of experience to work for you!**

**Call today and see why...**

***IT PAYS TO LEASE WITH US!***



**800.246.7997**  
**www.graniteleasing.com**

## Tech Perspective

# Injecting Long Life

**Chemical grouting provides simple and cost-effective repair for manhole leaks — if you use the right material and the right installation method.**

By Scott Kelly

**T**here are many ways to repair leaks in concrete structures like sanitary and storm pipes, manholes and basins. One of the oldest yet least understood methods uses polyurethane chemical grouts that react with water to bond with the concrete to form watertight, permanent seals, or to become rigid, filling voids and stabilizing soil.

According to the National Association of Sewer Service Companies (NASSCO), chemical grout was developed in 1955. Since then, it has been used in sewers, manholes,

first trenchless technology — is still a highly cost-effective, long-term defense against infiltration of groundwater into structurally sound sewer systems.

Grouting can be especially effective for sealing leaks in manholes, which by some estimates account for up to 40 percent of infiltration to wastewater collection systems.

### Reducing infiltration

The nation's infrastructure is aging while its population continues to grow. As a result, municipalities and contractors are under pressure to find effective repair options to reduce infiltration, which increases treatment plant loads, adds treatment cost, and increases the risk of sanitary sewer overflows (SSOs).

Groundwater leaks also carry sand, silt, and other debris into the system, increasing wear and tear on equipment. Voids often form around leaking structures that can lead to instability and settling. A properly chosen grout can stop leaks in seconds, forming a long-lasting seal and providing immediate cost-savings.

Some manholes require structural rehabilitation, usually involving a sprayed, hand-applied or cured-in-place (CIP) lining. Contractors and municipal crews must realize that groundwater infiltration needs to be stopped before such linings are installed.

Too often, leaks in manholes are treated by applying a quick-set hydraulic cement over the active infiltration. This stops the leak temporarily and allows time for the lining to be installed. But water remains within the primary structure and can weaken the bond and eventually cause a lining failure.

*Tech Perspective looks at technology-related issues and provides information and advice that cleaning professionals can apply to equipment selection and to their daily work in the field. Industry members are welcome to offer ideas for this column. Please direct them to editor Ted J. Rulseh, editor@cleaner.com.*

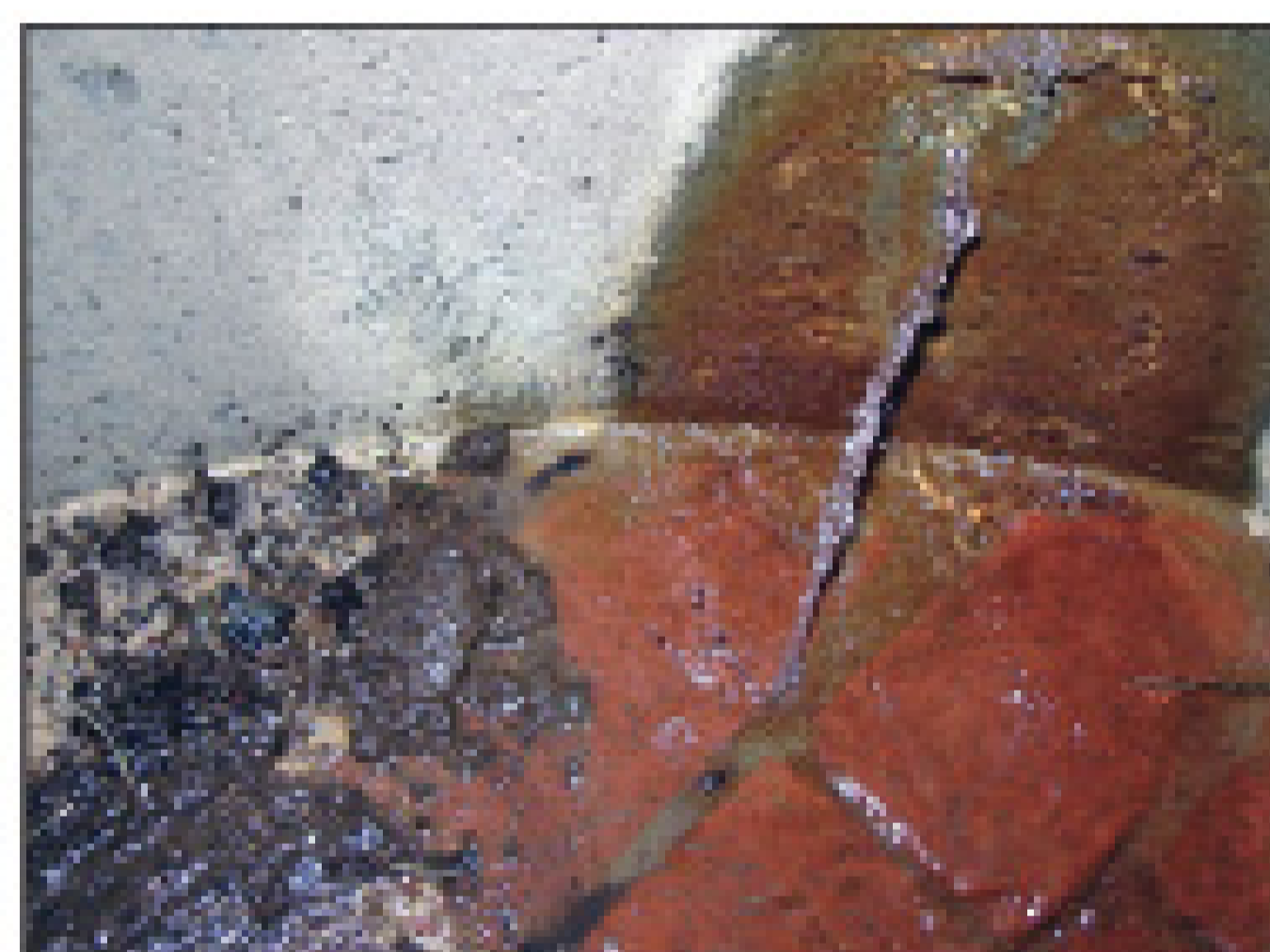

A crack at the base of a manhole allows water to infiltrate. (Photos courtesy Prime Resins Inc.)

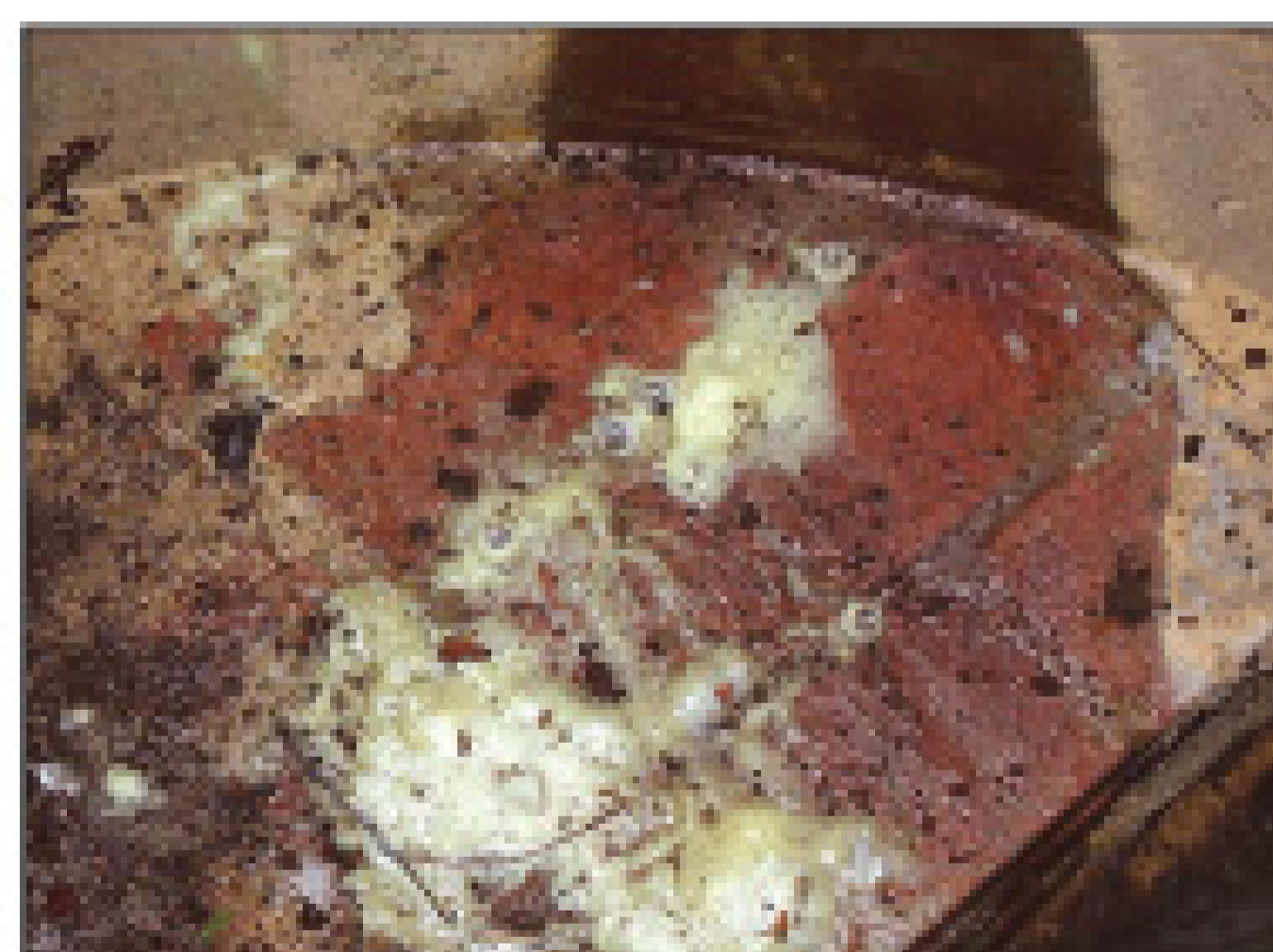

A hydrophilic chemical grout was used to repair the crack and stop all leaks.

tanks, vaults, tunnels, and many other applications worldwide.

Recent studies and more than 40 years of experience indicate that grouting — known as the nation's



An injection specialist uses chemical grout to repair a leaking joint.

---

**Grouting can be especially effective for sealing leaks in manholes, which by some estimates account for up to 40 percent of infiltration to wastewater collection systems.**

### Installation basics

Polyurethane chemical grouts are usually injected under pressure as a liquid resin into or near the leak. Once the resin contacts water, a chemical reaction occurs. Depending on the material formulation, the grout/water combination forms an expansive closed-cell foam or a gel. The foam can be flexible and resilient (hydrophilic) or rigid, meaning the cell structure of the foam crushes when compressed (hydrophobic).

In most manhole leaks, the water flow can be used to pull the grout into the structure. To accomplish this, a hole is drilled near the leak, and the chemical grout is

injected through the wall into the water source. As the resin reacts with the groundwater, it is pulled back into the structure and seals the leak from the outside in, creating a seal through the entire wall.

Where the leak is not strong enough to pull the grout into the structure, the grout can be injected directly into the defect. The expansion of the foam helps drive the grout through the structure to seal the gap. Hydrophilic polyurethane resins that produce gels are typically installed by running water along with the resin through a manifold that briefly mixes the two before they are injected. These gels are non-expansive but can be produced at

water-to-resin ratios as high as 15 parts water to one part resin.

### Knowing the material

Both hydrophilic and hydrophobic chemical grouts will seal leaks in all types of concrete structures initially. The issue is how to create a permanent seal. The longevity of the repair depends on choosing the right material. No single product will repair all leaks in concrete. Many products will temporarily fix a leak, but if applied correctly, most polyurethane grouting repairs are essentially permanent.

To break down the decision process, it helps to examine the basic properties of both hydrophobic and hydrophilic grouts. The properties of each type can be used to reduce installation cost and improve the quality and life of the repair.

**Hydrophilic grouts** (from Latin the *hydro*, for water, and *philic*, for affinity) can produce either closed-cell foam or a non-cellular gel when mixed with water. The reaction time is typically 30 to 45 seconds for foams and 12 to 15 seconds for gels. When activated, foams expand in volume from five to eight times. The volume of gel produced is relative to the ratio of water mixed with resin during installation. Hydrophilic gels can shrink after they cure in the absence of water.

Hydrophilic chemical grout likes water and can bond tightly to wet surfaces. Water-scavenging agents seek out water as they react and allow the resin to work its way into water-filled pores in concrete surfaces. Hydrophilic grouts are flexible and resilient after full cure and allow the structure to move without damage to the seal or bond.

**Hydrophobic grouts** (from the Latin *hydro*, for water, and *phobic*, for fear) require a catalyst that is blended into the resin before installation. The dosage of catalyst controls the reaction time and the volume of foam produced. When used with the maximum catalyst dosage (10 percent by volume), hydrophobic resins expand aggressively. The reaction time is 10 to 12 seconds, and the expansion can be up to 29 times.

Hydrophobic chemical grouts repel water after activation. When injected into a wet crack or joint, the resins can trap water in the pores of concrete. This trapped water becomes a bond inhibitor. Hydro-

phobic resins cure rigidly and do not recover from compression. If the structure moves, there is good chance the cell structure will be damaged and leaks will reappear. Hydrophobic grout has low viscosity and permeates loose soils readily.

### What to do

This basic knowledge of the two types of polyurethane grout helps in



Water enters the manhole due to a pipe penetration.

choosing the right product and the right method for a given repair.

If a leak repair involves a non-structural defect in a concrete or masonry structure, a hydrophilic chemical grout should be used, unless job conditions dictate otherwise.

Gels should be used only in below-grade structures where either moisture from the interior (like in a manhole) or from groundwater is present to keep the cured gel hydrated. Gels will shrink if water becomes absent, but provide a low-cost alternative to foams.

Foams are appropriate for above-grade or below-grade installation. They are typically 85 percent air-filled after cure and have excellent elongation, compression and rebound for use in expansion joints, cracks, or any other non-structural defect in concrete.

The aggressive expansion of hydrophobic chemical grouts is helpful in repairing a gushing leak that is impractical to repair with milder-expanding hydrophilic resins. In below-grade structures, this is a good way to fill voids that may be present outside the structure. Once the leak is reduced to a manageable level, hydrophilic resin should be injected into the defect to back up the hydrophobic material.

Hydrophilic gels can also be used to stop gushing leaks when injected near or with a 1:1 water-to-resin mix. In this case, it is necessary to push in as much material as

possible, as fast as possible. If a high-volume pump is available, less material will be used to stop the leak, because the high flow of resin reduces the dilution.

It is wise to use activated oakum (dry oakum soaked in hydrophilic resin) to reduce the flow in gushing leaks. If the leak can be slowed, a hydrophilic resin may be used to complete the repair.



Hydrophilic chemical grout is injected around the area. Activated by the water, the grout expands to seal off any leaks.

### What to avoid

Users should avoid installing gels in expansion joints or cracks that are subject to movement. Gels form a solid material with little or no

cellular structure to disperse tension under compression. This tension can split the gel and damage the seal.

It is also important to avoid installing hydrophobic chemical grouts for repairing minor leaks in cracks or joints. The repair will be temporary. Don't hurry when repairing tight cracks and minor leaks. These can be the most difficult to repair for the long term.

As infrastructure ages, chemical grouting will maintain its value as one of the easiest, most cost-effective and longest-lasting repair solutions available. If the right polyurethane chemical grout is chosen for a repair project, and the correct installation techniques are used, the repair will actually outlast the structure.

*Scott Kelly is a technical support specialist with Prime Resins Inc., a supplier of chemical groups based in Conyers, Ga. He can be reached at [skelly@primeresins.com](mailto:skelly@primeresins.com).* ■

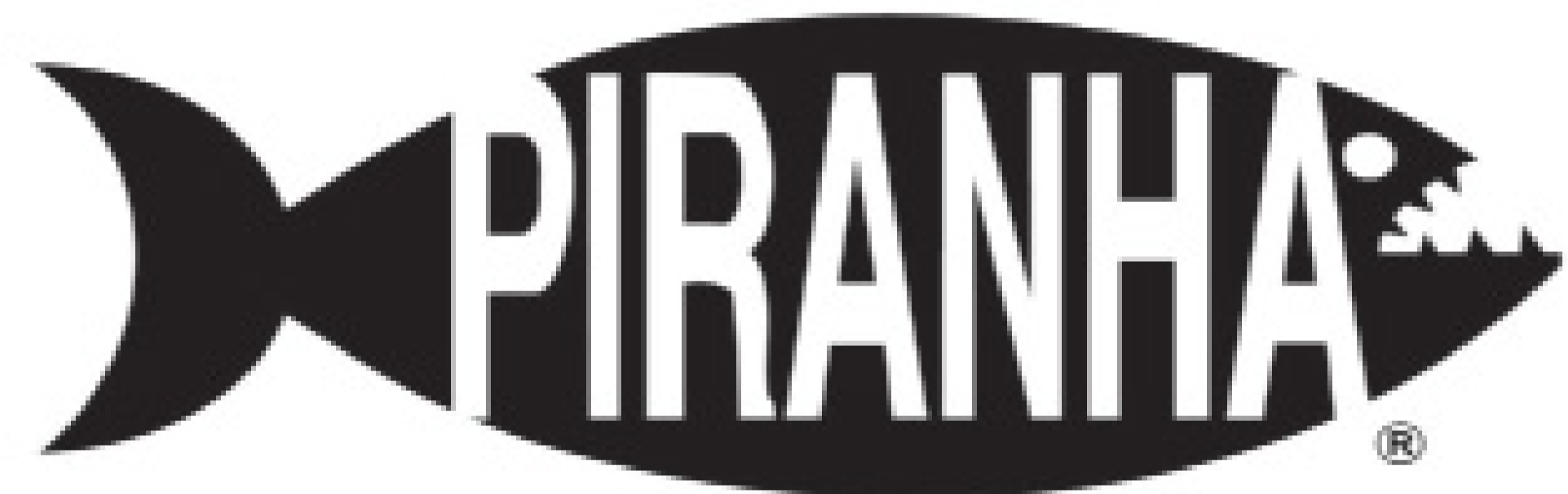

**HOSE PRODUCTS, INC.**

**YOU KNOW IT'S  
THE BEST**

**ASK ABOUT OUR ARMOR BELT**

CALL FOR A DISTRIBUTOR NEAR YOU.

1-800-250-5132

[sales@piranhahose.com](mailto:sales@piranhahose.com)

[www.piranhahose.com](http://www.piranhahose.com)



# YOU CAN INSTALL SEWER and WATER LINES

(WITHOUT DIGGING A TRENCH!)

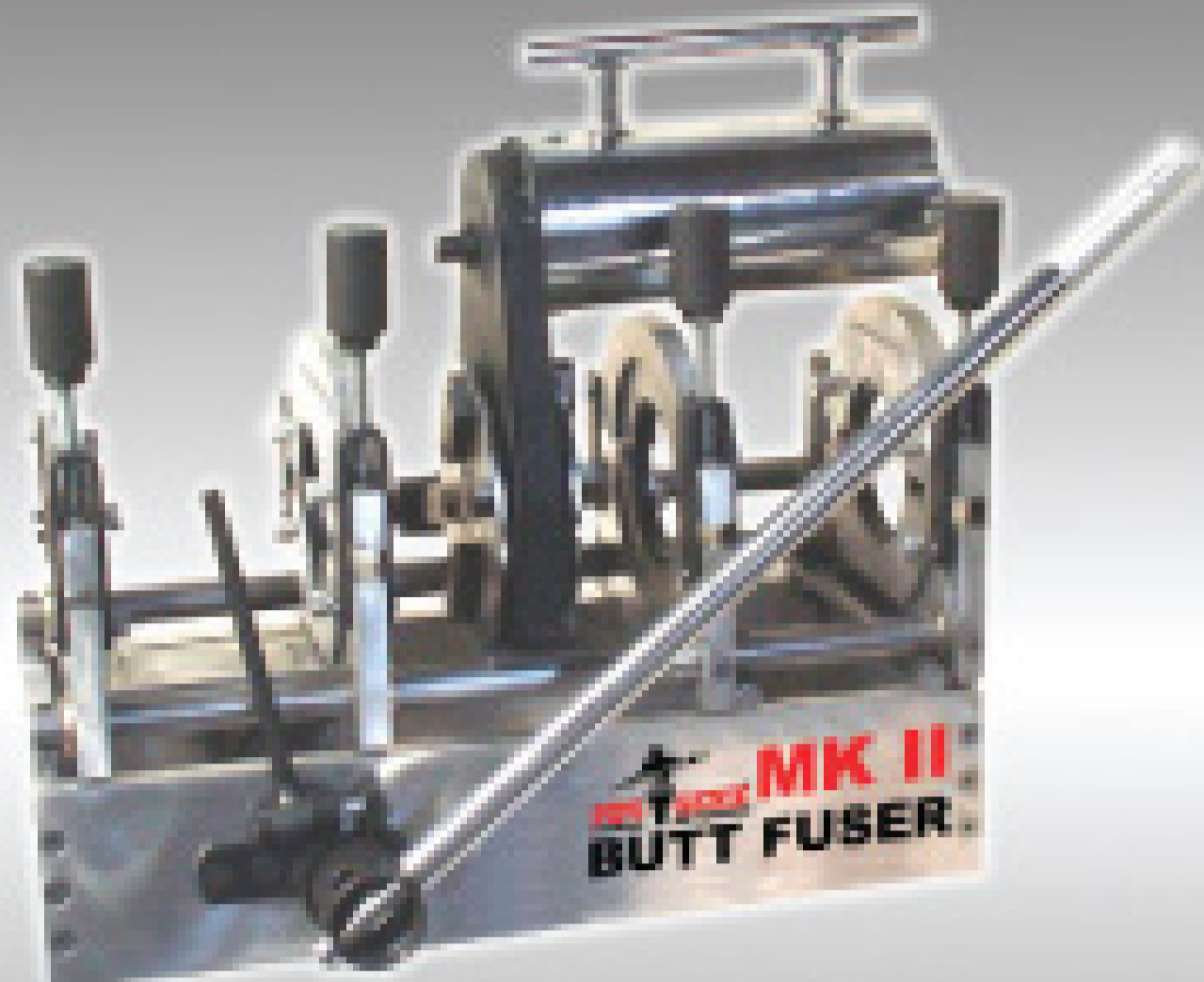

## HOT BEAD FUSING 2-8"

Save time with inline fusing as you continuously pull PE pipe!



## Ream Inner Beads 3-16"

Models to accommodate pipe diameters ranging from 4 inches to 20 inches! (24 and 40 foot kits available.)

## Pipe Genies Do It All!!

Ductile & Cast Iron, Clay & Concrete, ABS, PE & PVC

## Pipe Genies Pull Any Pipe!!

System Power From 20 Tons to 240 Tons! (Rated for 1/2" job pipe)

## Pipe Genies Work Anywhere!!

The Most Compact Systems Available!

We have everything you need to get started making profits with pipe bursting!



## PIPE BURST 1/2-30" PIPE

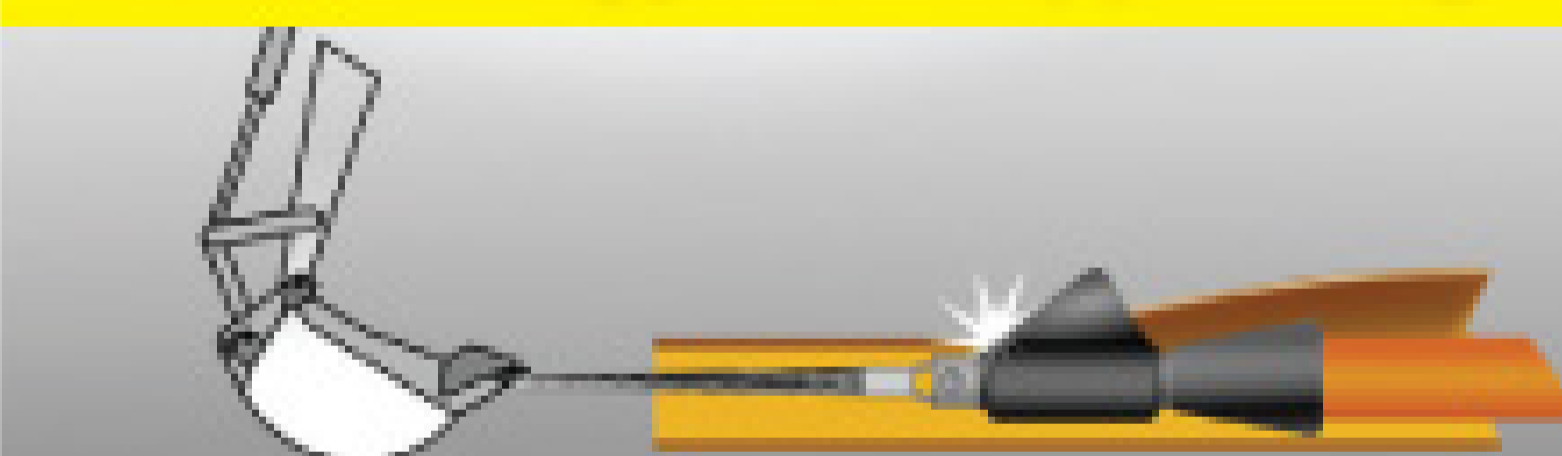

## Slice Old Water Pipe

Easily handle those 1" copper pipes with brass fittings, and tricky 1"+ schedule 80 steel gas line pipes!



## 2-in-1 Convenience Bore then Pull!

Bore through existing lines or create new ones. When complete transform into a hydraulic pulling unit & haul back the new pipe!



# Videos Now Online!



www.TrenchlessAmerica.com

Toll Free  
1 877 411 7473

# CT 2000™

## CITRUS GREASE EMULSIFIER/DRAIN MAINTAINER

NO OTHER PRODUCT WORKS FASTER OR HARDER ON GREASE.

WE GUARANTEE IT!

CT 2000 is:

- Environmentally safe
- Safe on all pipes
- Non acid, non caustic
- Non toxic
- Leaves drains citrus fresh
- Super concentrated – 1 gallon makes 5 gallons



TREAT YOURSELF TO BIG PROFITS!  
TREAT DRAINS WITH CT 2000!

Mention This Ad and Receive 10% Off Your First Order!  
Free Brochures With All Orders.



1815 E. Wilshire Ave. | Santa Ana, CA 92705

tel: 866-803-3466

fax: 714-835-3570

www.ct-2000.com



## Petersen Mechanical & Inflatable Pipe Plugging Systems

For all your Pressure, Chemical, and Temperature Requirements



Call us to quickly customize a pipe plug or plugging system for your specific application.

Mechanical Plugs for high and low pressure requirements.

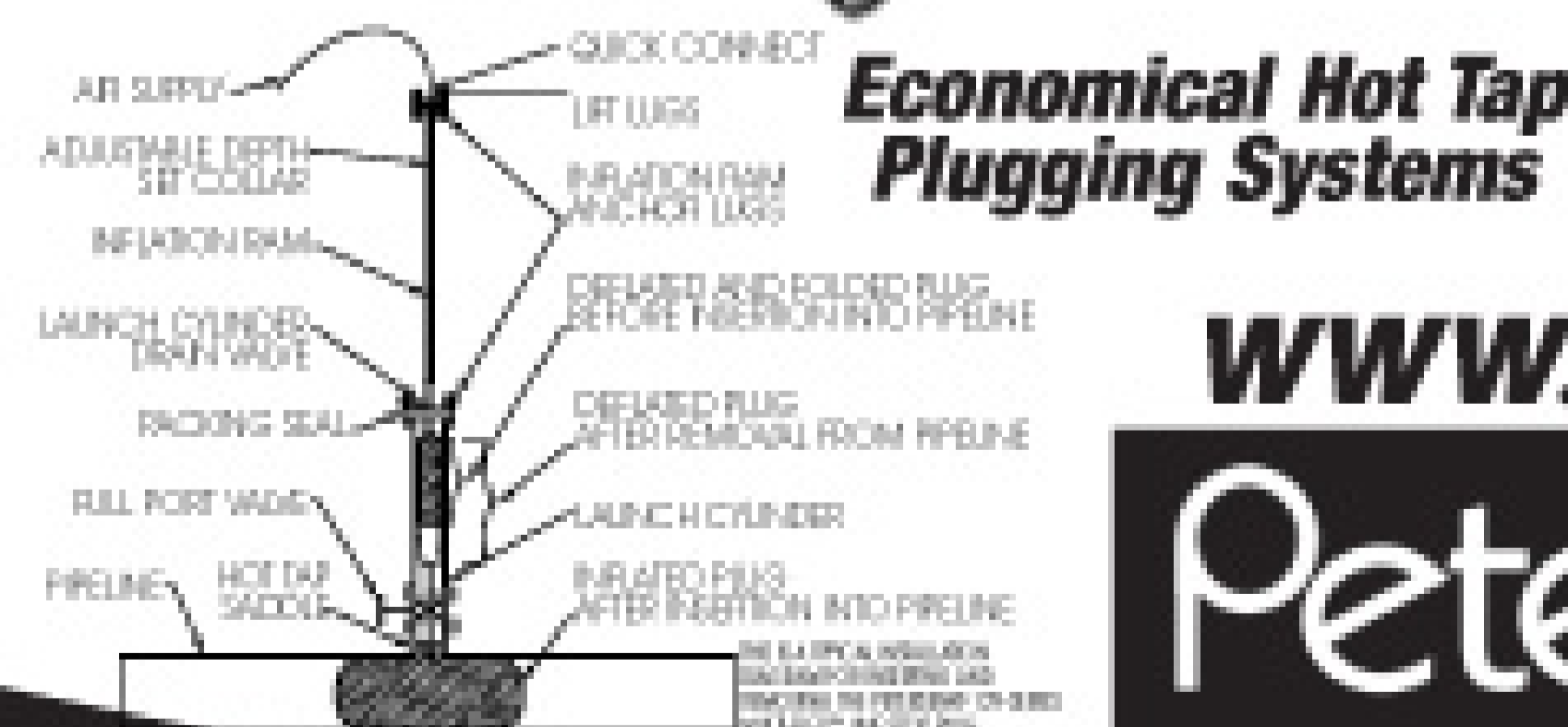

Economical Hot Tap Plugging Systems



www.pipeplug.com

Petersen PRODUCTS COMPANY

421 WHEELER AVE • FREDONIA, WI 53021

PHONE 800.926.1926 OR 262.692.2416

FAX 800.669.1434 OR 262.692.2418

Quality Products For Professionals Since 1916





1-800-333-9274 East \* 1-800-786-9274 Custom  
 1-800-351-7283 HONDA Parts \* 1-800-964-9274  
 1-800-454-9274 Open Till 7:00pm West

\* Apply For 30 Day Terms Account  
 \* Low Interest Lease Plan  
 \* 5 Offices To Serve You  
 \* Free Lifetime Tech Support

### Manual Hose Reel 13" High



Model	Capacity	3+	Each
27.0006	50'	<del>\$42.99</del>	<del>\$49.99</del>
27.0004	100'	<del>\$52.99</del>	<del>\$59.99</del>

Includes: Swivel, Mounting Plate, Locking Mechanism, Solid Steel Construction & Durable Powder Coating

### Manual Hose Reel 16" High



Includes: Swivel, Mounting Plate, Locking Mechanism, Solid Steel Construction & Durable Powder Coating

Model	Capacity	3+	Each
27.0005	150'	<del>\$67.99</del>	<del>\$79.99</del>
27.0007	200'	<del>\$79.99</del>	<del>\$89.99</del>

Also Available:  
 300' \$119.99  
 350' \$129.99 (Styles Vary)

### Portable Manual Hose Reel



Aircraft Grade Aluminum With Rubber Feet, Stable, Light Weight Design

Part #	Capacity	Each
13805	50'	<del>\$114.99</del>
13810	100'	<del>\$125.99</del>
13815	150'	<del>\$142.99</del>
13820	200'	<del>\$159.99</del>

### Portable Hose Reel Carts



Fully Portable Cart W/ Pneumatic Wheels, Baked on Enamel Finish, 4500PSI Working Pressure With Live Swivel. Includes Adjustable Drag, Spring Loaded Pin Lock, 3/4" Unbreakable Axle, 10" Air Tires, Quick Connects & Well Balanced.

Model	Capacity	3+	Each
PHR-250	250'	<del>\$289</del>	<del>\$319</del>
PHR-350	350'	<del>\$339</del>	<del>\$369</del>

8' 4000PSI Jumper Hose W/ Qc's Included

### HOSETRACT M-Series

Manual Hose Reels. Adjustable Brake, 200 F. Degree/4000PSI Rated



Model	Capacity	Each
M10-5	250'	<del>\$168.13</del>
M15-5	350'	<del>\$181.25</del>
M20-5	450'	<del>\$210.71</del>
M25-5	550'	<del>\$222.44</del>

Roller & Guide Systems, Stainless Steel, 7000PSI Internals, Chemical Resistant Swivels Are Optional

### HOSETRACT Low-Pro Series

Same Features As The M-Series with A Low Profile Frame - Great Space Saver

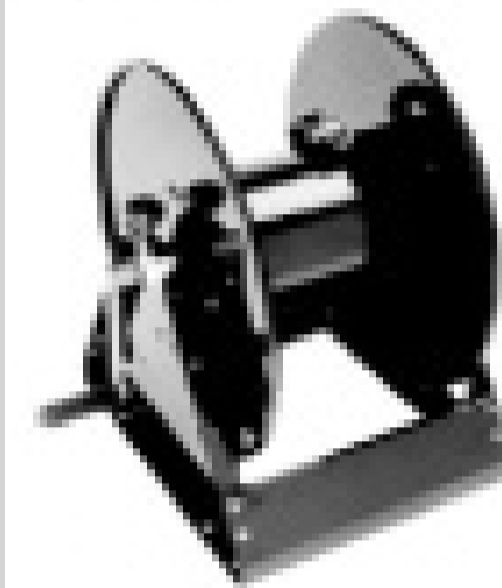

Model	Capacity	Each
M10-5LP	150'	<del>\$161.17</del>
M15-5LP	225'	<del>\$168.45</del>
M20-5LP	300'	<del>\$215.54</del>
M25-5LP	375'	<del>\$218.67</del>

Roller & Guide Systems, Stainless Steel, 7000PSI Internals, Chemical Resistant Swivels Are Optional

### Stack Frame Design

Allows Stack-able Hose Reel Installation And Saves Floor Space

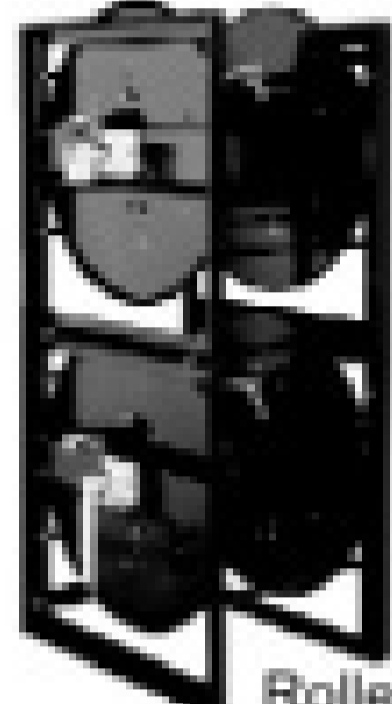

\*\*Image Shows 2 Units\*\*

Model	Capacity	Each
SFM10-5	250'	<del>\$176.40</del>
SFM15-5	350'	<del>\$189.95</del>
SFM20-5	450'	<del>\$221.23</del>
SFM25-5	550'	<del>\$234.83</del>

Roller & Guide Systems, Stainless Steel, 7000PSI Internals, Chemical Resistant Swivels Are Optional

### HOSETRACT E - Series

12 Volt DC Motor Driven Electric Rewind Reels



Model	Capacity	Each
E15-5	350'	<del>\$413.14</del>
E20-5	450'	<del>\$446.43</del>
E25-5	550'	<del>\$464.47</del>

Guide Systems for 15" - 20" - 25" Wide Reels Are Available. We Recommend Factory Pre-Wired Option For \$29. 7000PSI Internals, Chemical Resistant Swivels Are Optional

### Jumper Hose / Whip Line 3/8" MPT Swivel x Rigid

#### 4000PSI

2'	30.0026	<del>\$10.99</del>
3'	30.0027	<del>\$11.29</del>
4'	30.0028	<del>\$12.39</del>
5'	30.0029	<del>\$13.59</del>
6'	30.0030	<del>\$14.99</del>
8'	30.0031	<del>\$17.99</del>
10'	30.0032	<del>\$20.99</del>
15'	30.0033	<del>\$26.99</del>

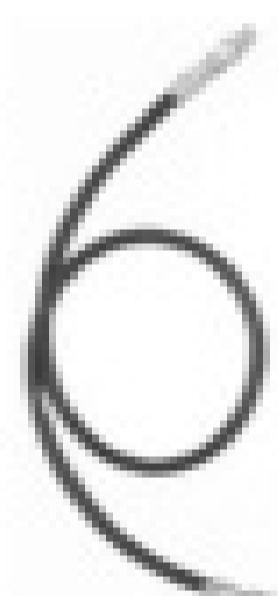

# 5665.00  
 Qc's Add  
**\$3.99**

#### 5800PSI

2'	30.0034	<del>\$14.99</del>
3'	30.0035	<del>\$16.39</del>
4'	30.0036	<del>\$17.79</del>
5'	30.0037	<del>\$19.99</del>
6'	30.0038	<del>\$21.39</del>
8'	30.0039	<del>\$23.99</del>
10'	30.0040	<del>\$26.99</del>
15'	30.0041	<del>\$33.99</del>



Custom Lengths  
 Up To 200'

### TURF TREAD RUBBER TIRES

Part #	Size	Each	5+	20
22.0106	13" Air 3/4" Bushing	<del>\$9.99</del>	<del>\$8.99</del>	<del>\$8.09</del>
22.0082	13" Foam 3/4" Bushing	<del>\$18.99</del>	<del>\$17.49</del>	<del>\$16.99</del>
22.0107	10" Air 3/4" Bushing	<del>\$6.49</del>	<del>\$5.99</del>	<del>\$5.39</del>
22.0083	10" Foam 3/4" Bushing	<del>\$9.99</del>	<del>\$8.99</del>	<del>\$8.09</del>
22.0108	10" Air 5/8" Bushing	<del>\$6.49</del>	<del>\$5.99</del>	<del>\$5.39</del>
22.0084	10" Foam 5/8" Bushing	<del>\$9.99</del>	<del>\$8.99</del>	<del>\$8.09</del>



Foam Tires Have Metal/S.S. Bearings  
 Air Tires Have Poly Bushings

### COOL DECK Aluminum Frames

Direct Drive - Assembly Required  
 Premium Upgrade Features



Model	Fits	Each
WCA008	6.5HP	<del>\$99</del>
WCA030	13HP	<del>\$119</del>
WCA040	24HP	<del>\$149</del>

Hose & Gun Rack, Add \$19 /  
 WARNING Labels Add \$8.99

### COOL DECK Aluminum Skids

Direct Drive - Assembly Required  
 Includes: Legs & Shock Absorbing Feet

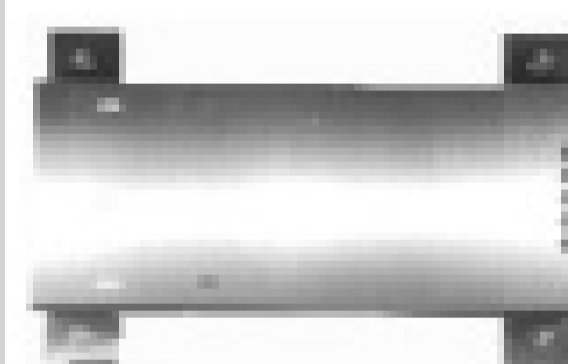

Model	Fits	Each
WCA075	6.5HP	<del>\$88</del>
WCA076	13HP	<del>\$106</del>
WCA077	24HP	<del>\$137</del>

Assembly Available Add \$28/  
 WARNING Labels Add \$8.99

### Cool Deck Aluminum V-Belt

V-Belt Drive - Assembly & Experience  
 Required



Model	Fits	Each
WCA082	6.5HP	<del>\$179</del>
WCA080	13HP	<del>\$189</del>
WCA083	24HP	<del>\$229</del>

We Stock A Full Line of V-Belts & Pulleys  
 (Non-Returnable)

### Cool Deck Aluminum Roll Cage

Direct Drive - Assembly Required



Model	Fits	Each
WCA100C	13HP	<del>\$258</del>

Several Jumper Hose &  
 Hose Reel Options Available

Includes: Mounting Plate, Hardware & Adaptor  
 Fittings, Roll Cage Models Only.  
 The Above Engine, Pump & Reel Is Not Included.

### Pump Repair Specialists

- \* Online Schematics
- \* Full Service Distributor



1-800-964-9274

See: [www.WaterCannon.com](http://www.WaterCannon.com)

### BEST Sellers ALWAYS on Sale

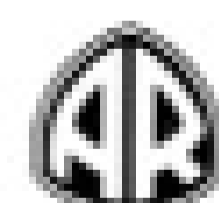

5.6GPM @ 4000PSI ~~\$399~~  
 8.0GPM @ 3500PSI ~~\$499~~  
 7.0GPM @ 5000PSI ~~\$599~~

Call For Free Quotation.  
 We Also Stock Pumps With Left Hand Drive,  
 Tapered Shaft, Car Wash Duty,  
 316 Stainless Steel and Unique Applications

1-800-964-9274

### Hydraulic Drive Pressure Washers

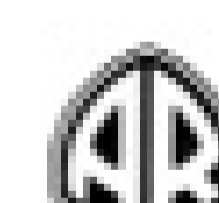

3.0GPM @ 2000PSI ~~\$539~~  
 4.0GPM @ 2200PSI ~~\$649~~  
 4.0GPM @ 3000PSI ~~\$689~~

Call For  
 Details & Hydraulic System Requirements  
 1-800-454-9274

### High Performance AR Pumps

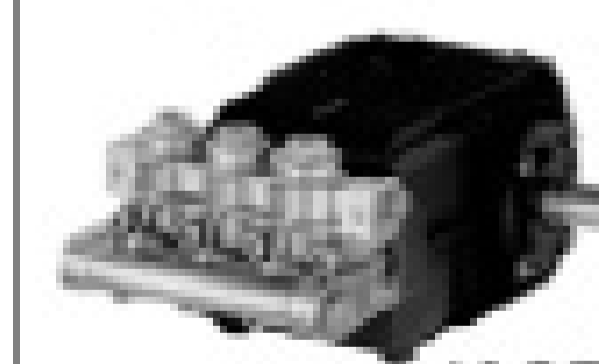

13GPM @ 1450PSI ~~\$579~~  
 11GPM @ 3000PSI ~~\$629~~  
 5.8GPM @ 7250PSI ~~\$1,099~~  
 10GPM @ 7250PSI ~~\$3,899~~  
 44GPM @ 1500PSI ~~\$4,199~~

We Stock 1000's of Pumps  
 For Same Day Shipping!



Build A Custom System With Water Cannon's Unique Selection Of Products  
 Call Our Custom Specialists @ 1-800-454-9274





**SEWERIN**

**No more tumbling dice**

**Stethophon® 04**  
Hi-Performance hand-held water leak detector

**Stop taking chances on less quality!**

**No more gambling!**

Sewerin USA, LLC • 13551 W. 43rd Drive, Unit R • Golden, CO 80403-7272  
Phone 303-424-3611 • Fax 303-420-0033 • www.sewerin.net

RLWA-BI 03/02/01/2008



**G&R**  
**CABLE**

High Quality Cables and Accessories  
Drain Cleaning Equipment and Supplies

**FAST SERVICE & LOW PRICES!**

**G&R CABLE CO., INC.**  
11112 S. PEEBLY RD. • NEWALLA, OK 74857  
405.386.6718 • FAX 405.386.4098  
**800.398.6718**

**fss SOLUTIONS**  
SALES • RENTALS • PARTS • SERVICE

**We've got you covered**



New 2008 Liquid Vacuum Tank, 3,000 Gallon, DOT Spec, Fruitland 500 Vacuum Pump (350 CFM)  
**2 TO CHOOSE FROM!**



1998 Guzzler CF Ace,  
Roots Blower  
**CALL FOR DETAILS!**



ID# 18649 2004 Vactor Hydro Excavator,  
Dual Stage Fan, Telescoping Boom  
**CALL FOR DETAILS!**

**Many More Units Available • Call for Details!**

Parts and Service  
Financing for Used Equipment and Service  
Warranties for Most Equipment  
We Sell and Service

The Largest Selection of Refurbished  
Vacuum Trucks in the World

**1-800-822-8785**  
[www.fssolutionsgroup.com](http://www.fssolutionsgroup.com)



**We've got you covered**

# FS Solutions™

**Your Resource for Used Equipment Sales, Service, Parts and Rentals\***

**From the people who bring you Guzzler, Jetstream and Vactor, the brands you know and trust, we bring you FS Solutions.**

- **High-performance parts** for most makes and models of industrial vacuum loaders and waterblasters
- **Wide range of accessories** for industrial cleaning
- **Repairing and rebuilding** of equipment, pumps, and blowers
- **Large selection of refurbished vacuum trucks**
- **Jetstream waterblast rental units** ranging from 170-300 HP, pressures convertible from 10-20-40k psi
- **Waterblast safety training** and same day nozzle drilling



**Birmingham, AL**  
8584 Borden Ave. SE  
Leeds, AL 35094  
800/822-8785

**Houston, TX**  
2500 E. Pasadena Freeway  
Pasadena, TX 77506  
713/472-1529

**Streator, IL**  
2108 Coalville Rd..  
Streator, IL 61364  
800/822-8785

**Toledo, OH**  
1144 Expressway Drive South  
Toledo, OH 43608  
888/415-RENT (7368)

**Long Beach, CA**  
1510 Hayes Ave.  
Long Beach, CA 90813  
866/515-9891

\* Offerings vary by location.

©2008 Federal Signal Environmental Solutions Group

# Life and Death

**Contractors and municipal agencies emphasize safety for confined-space entry, trenching, and other potentially dangerous duties their people may face**

By Mary Shafer

In the summer of 2002, two CIPP technicians, ages 25 and 19, were overcome by toxic sewer gas and drowned while walking through a 600-foot section of underground sewer in Iowa. Five co-workers who tried to rescue them were also overcome, but later recovered in the hospital.

Investigators found that the workers' employer, in business more than 25 years with 1,500 employees, was negligent in failing to provide adequate training for confined-space safety. The employer was also found not to have properly ascertained the hazards of the work site from the contractor, nor provided oversight to ensure the proper use of respirators and other safety equipment.

The deaths could have been prevented. Yet, these fatalities continue to occur at an alarming rate, and it's not just isolated individuals working in less-than-safe conditions who are affected. According to the National Institute for Occupational Safety and Health (NIOSH), more than 60 percent of confined space fatalities are would-be rescuers, as unprepared to encounter hazardous conditions as those they try to save.



**David Johnson**

Utility Supervisor III  
City of Raleigh (N.C.)  
Public Utilities Dept.  
Employees: 18

In an industry that depends largely on young men whose bravado may trump a sense of safety, it's critical to require comprehensive safety training. Since much contract cleaning requires operating in confined spaces, which are often hazardous, this training is especially important. What are

you doing to ensure the safety of your employees? It's a consideration not taken lightly by these cleaning operators.

The **City of Raleigh** takes no chances with its human resources. Each new hire in its Public Utilities Department who may be involved in field work is sent to Fayetteville, N.C., or to Atlanta, Ga., for 10 hours of Competent Person training, a total of three times in their first year of employment. Thereafter, every utility employee must return for an annual refresher course that keeps them updated on new federal and state regulations and new safety technology they may be expected to use on the job.

**"No one enters a confined space unless I or my operations manager is there with them. We've been trained by another company, and we oversee any work."**

**Jim Meredith**  
ABC Sanitation Inc.  
London, Ontario

"Trenching and excavations, confined-space entry, anything they might be required to do," is what these workers learn during training, according to **David Johnson**, utility supervisor III. Part of his job is to monitor these workers on the job. That includes making sure the complete pre-entry checklists for confined-space work is followed. He ensures that gas monitors and fresh air blowers and other necessary items are on site and in use.

"We also teach everyone how to fill out readings of potential toxic gases and other hazards to apply for a site permit," says Johnson.

"No one enters a confined space unless I or my operations manager is there with them," says

**Jim Meredith**, president of **ABC Sanitation**, a sewer and drain cleaning firm in London, Ontario, about halfway across the stretch of Canada that separates Lake Erie from Lake Huron. "We've been trained by another company, and we oversee any work."

Though there's no explicit ongoing training program separate from the work itself,

Comments may be directed to Mary Shafer in care of Cleaner. You may also e-mail pipelines@cleaner.com.



ABC field technicians are thoroughly briefed before each job about potential safety hazards related to confined-space entry and other aspects of the project. Then Meredith or his operations manager carefully monitors the operation and use of harnesses, masks and other safety gear, along with acceptable safety practices.

Anything deemed unacceptable is called out immediately and corrected, then discussed during a project postmortem on the way back from the job.

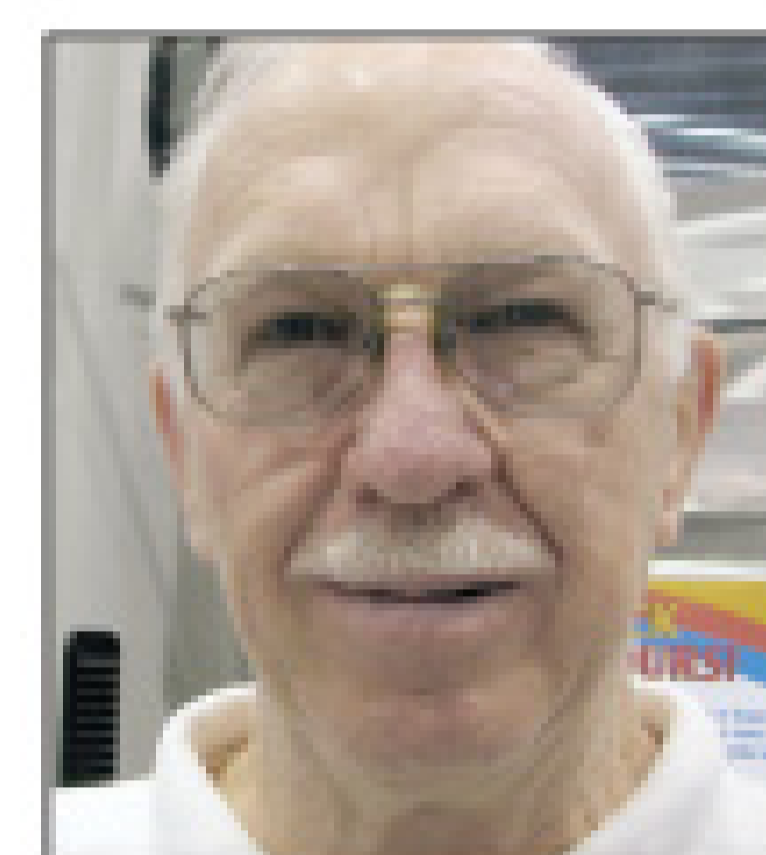

**Jim Meredith**

Owner  
ABC Sanitation Inc.,  
London, Ontario  
Employees: 6  
Years in Business: 38

There's not a big problem with having to train new workers, says Meredith. "We've been very fortunate to have the same guys now for a number of years."

Wastewater collection superintendent **Wayne Terry** works for the **City of Pampa** (Texas) Department of Public works. He oversees a department of four in this seat of Gray County in the Texas Panhandle. Safety is a paramount concern. New hires attend a required 8-hour general training program that includes guidelines for safe operation of all heavy equipment.

After that, confined-space training is conducted by representatives from the Texas Commission on Environmental Quality (TCEQ). This is part of the mandatory Water Utility Safety course of the state

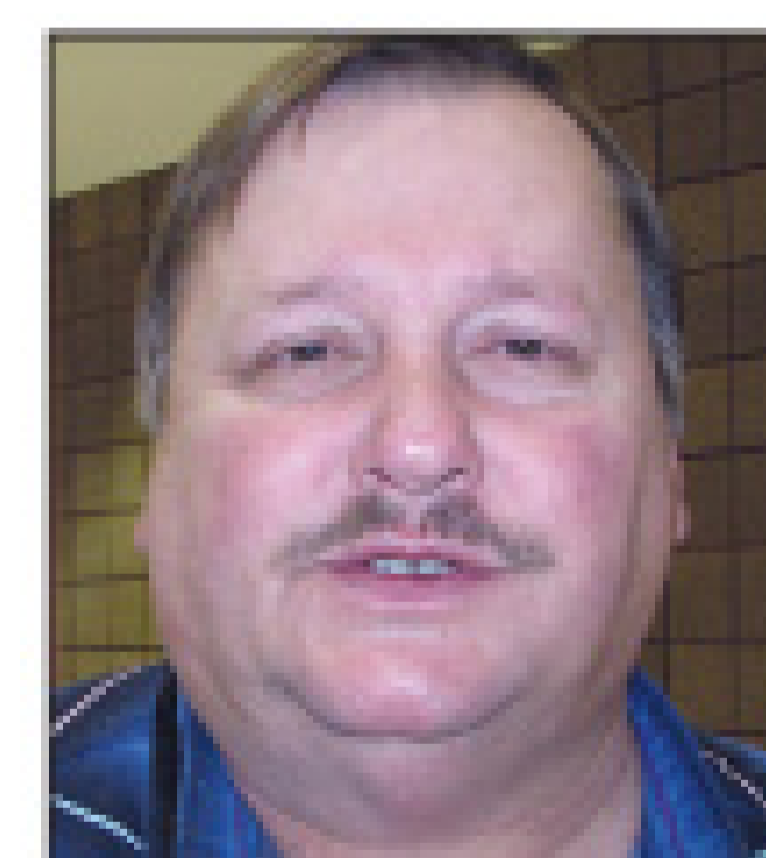

**Wayne Terry**

Wastewater Superintendent  
City of Pampa (Texas)  
Dept. of Public Works  
Employees: 4

regulatory body's Wastewater Licensing program.

All of Terry's employees must complete this annual certification program and occasional refresher and update courses. "We're constantly upgrading or renewing our people's certifications," says Terry. "Depending on the position, that happens every two to three years. Vendors come in regularly to demonstrate the safety aspect of using their products and equipment. Each month, attendance is mandatory at a safety training film." ■

**We have the ultimate bin and shelving system for your vehicle.**

**Hackney**

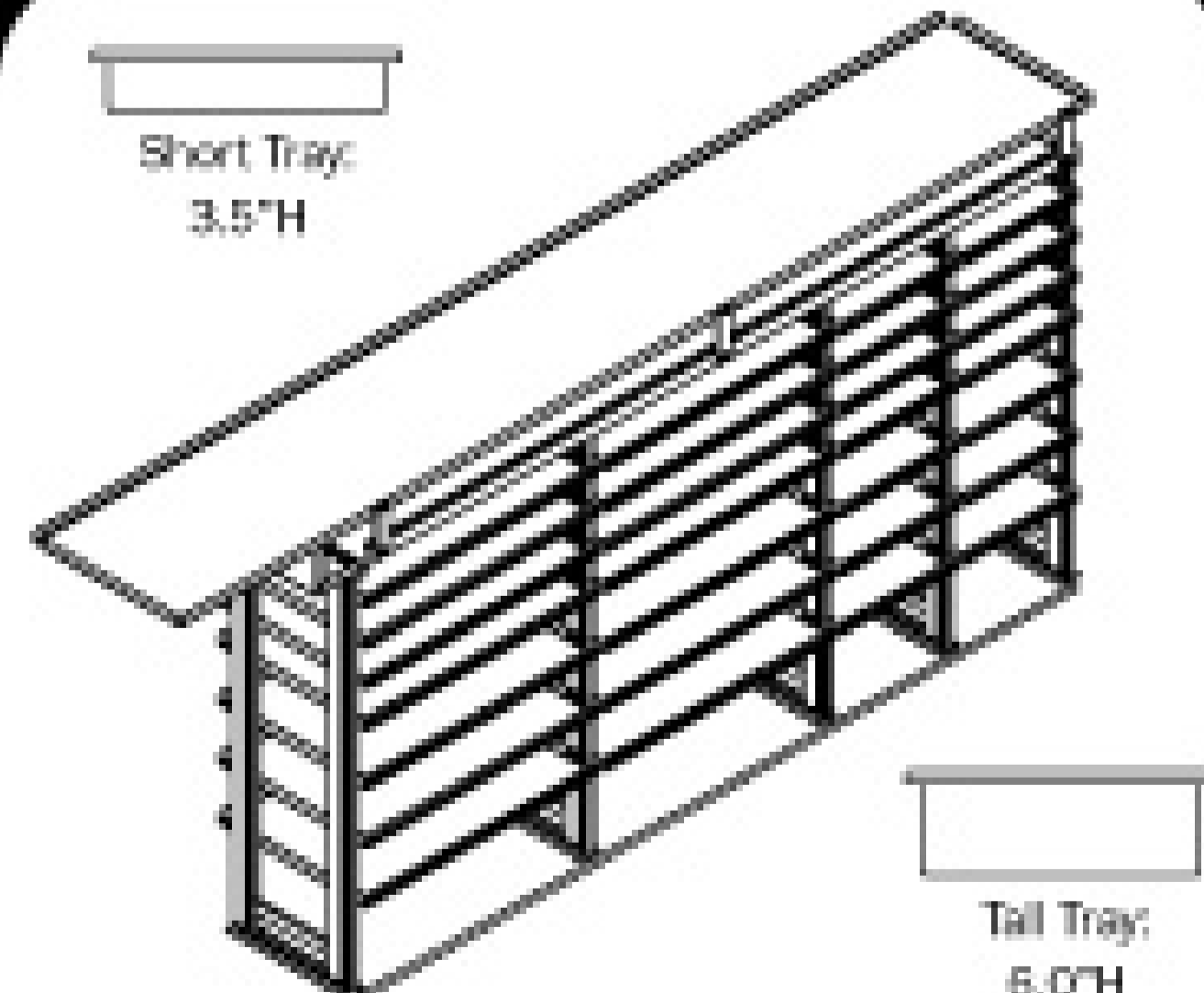

Call Derreck or Randy toll free  
**1-877-238-7278**

**KMT Aqua Dyne provides powerful water blasting performance with proven reliability to fit your water blasting application.**

For over 38 years, KMT has been supplying water blasting equipment to the water jetting industry.

Join the thousands of customers worldwide who have come to depend on KMT to do the job right!

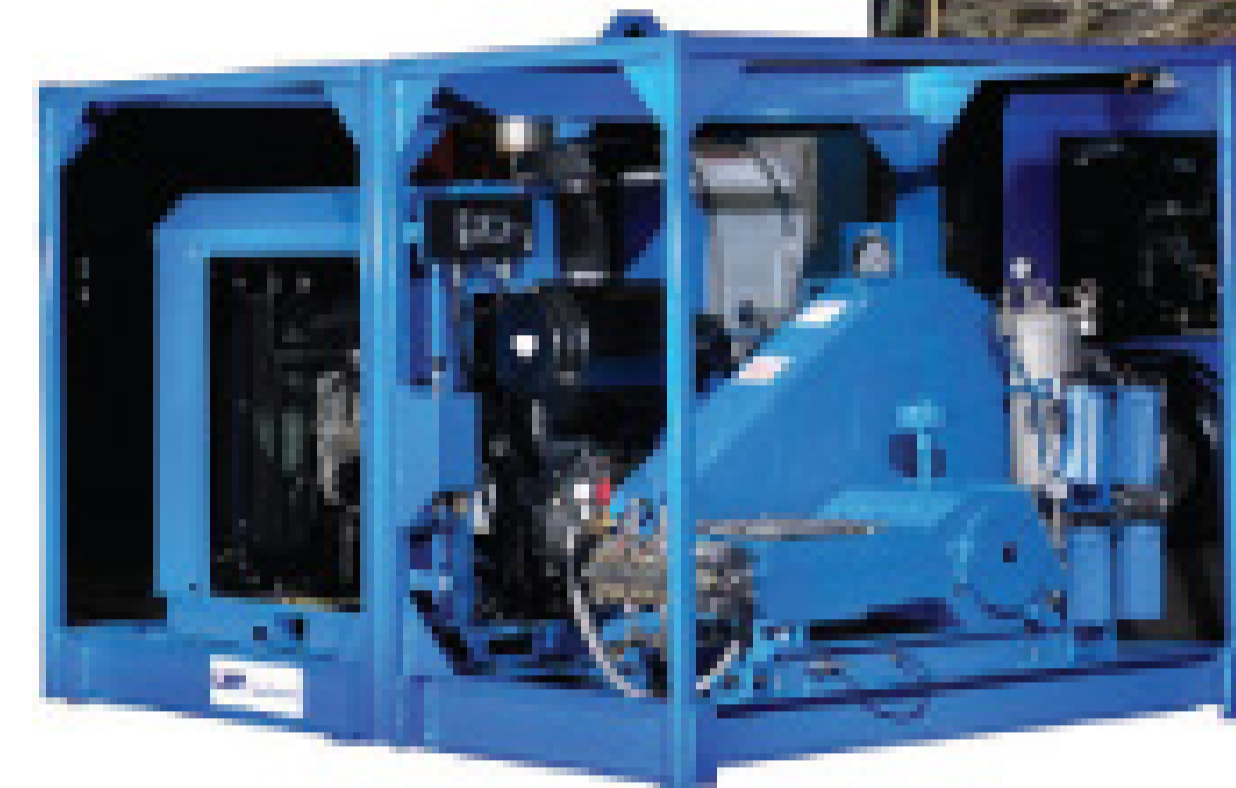

**KMT. Water blasting reliability and performance.**

*KMT. Creating value through precision.*

Aqua-Dyne L.P.  
www.kmtgroup.com  
713-864-6929



## ALL STAR EQUIPMENT SALES INC. 1-800-950-5023



### MAXI-ROOTER... Call For Price

Complete and ready to operate with Power Cable Feed, SRCS cutter set, and 100 ft 3/4" and 25 ft 3/4" cables.  
*\*FREE SHIPPING*



### SPEEDROOTER 91... Call For Price

Complete and ready to operate with power cable feed 100 ft 3/4" cable, 100 ft 1/2" cable in small drum, and COCS cutter set.  
*\*FREE SHIPPING*

**General and Insight Vision are some of our leading brands.**  
We Specialize In: Sewer Machines, Cables, Cutters, and Cameras.



### MINI-Rooter XP... Call For Price

Complete and ready to operate with Power Cable Feed, MRCS Cutter set, and 75 ft 3/8" cable.  
*\*FREE SHIPPING*



### Gen-Eye GL... Call For Price

Complete and ready to operate with 200 ft Standard Reel with Self-Leveling Color Camera and Command Module with DVD Recorder.  
*\*FREE SHIPPING*

For more products visit: [stores.ebay.com/All-Star-Equipment-Sales-Inc](http://stores.ebay.com/All-Star-Equipment-Sales-Inc)  
For 24 Hour Customer Support Dial **1-800-950-5023**

# VT Vision Technology

**24 Hour  
Leak Expert  
Hot Line**



**INTRUDER™**  
Video Inspection System



**MINI INTRUDER™**  
Video Inspection System



**INTRUDER™ 4000**  
Precision Locator Locates Both  
512HZ and 874HZ



**INTRUDER™ ELITE**  
Video Inspection System

- Now Self Leveling Cameras Available
- Extended Warranties Available
- Now Serving All Of Europe
- Local Service Centers Throughout The US & Canada
- Flexible Lease Terms Available



**VT-2000™**  
Professional Leak Detection System



**VT-1000™**  
Professional Leak Detection System



**DVD Recorder**

For Your Local Representative Call  
**877-754-3435**

2548 South Paulson Rd., Suite B • Turlock, CA 95380 • fax: (209) 668-5847 • email: [info@vtdesign.com](mailto:info@vtdesign.com)  
phone: (877) 754-3435 or (209) 668-5840 • web: [www.vtdesign.com](http://www.vtdesign.com)

## “Your One-Stop Stopper Shop!”

FOR 31 YEARS – HOME OF THE ORIGINAL

### PIPE PLUG & NB BAG/PILLOW DESIGN STOPPER

[ SINGLE SIZE OR MULTI SIZE PIPE STOPPERS 4" & UP ]

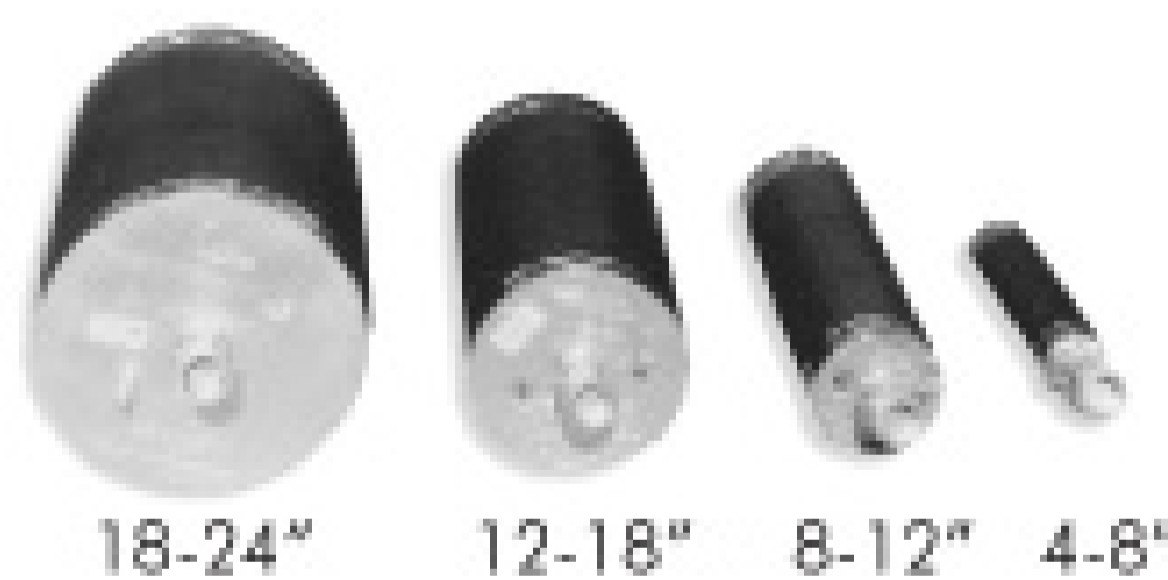

18-24" 12-18" 8-12" 4-8"

#### J PLUGS

- Four J-Plugs do the job of 12 plugs
- Field repairable
- Above ground installation



#### NB MULTI SIZE BAG/PILLOW STOPPERS

- Great for elliptical & other non-round applications
- Natural rubber construction
- Also available with Flow Thru

#### SINGLE & MULTI SIZE PASS THRU PLUGS

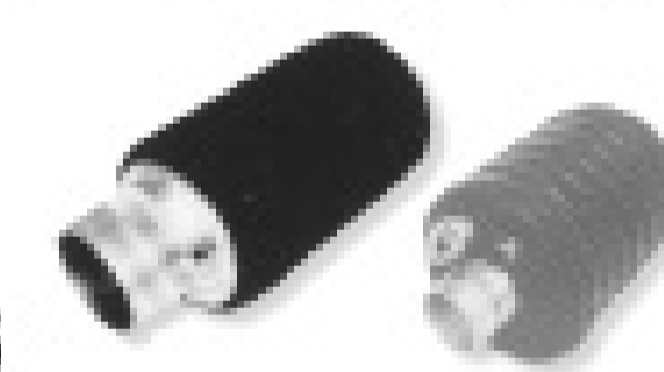

#### MULTI SIZE PLUGS & MULTI SIZE LEAK LOCATORS



#### SINGLE & MULTI SIZE TEST PLUGS



**COMPLETE LINE OF SEWER & DRAINAGE TOOLS AVAILABLE**

disc plugs | high pressure plugs | large inflatable pipe plugs | pipeline testing & acceptance plugs | pneumatic by-pass plugs

## SEWER EQUIPMENT CO. OF FLORIDA, INC.

P.O. BOX 186 | 1102 N. DIXIE FREEWAY | NEW SMYRNA BEACH, FL 32170-0186 USA  
IN FLORIDA **800.225.2952** | OUT OF FLORIDA **800.635.2323** | IN CANADA **800.328.3318**  
FAX **386.427.4552** | E-MAIL [sewerequip@worldnet.att.net](mailto:sewerequip@worldnet.att.net) | WEB SITE [www.sewerequipmentco.com](http://www.sewerequipmentco.com)

COMPLETE LINE OF SEWER MAINTENANCE TOOLS

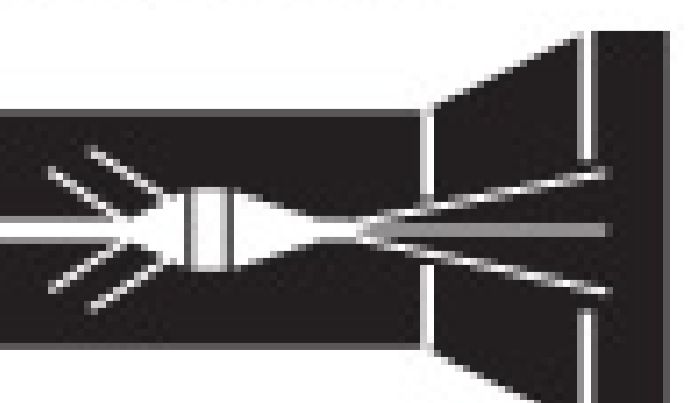

# INTRODUCING MaxLinerCLS

The latest and most comprehensive inside-out, mainline-launched lateral sealing and relining CIPP system around.

**MAXLINER<sup>®</sup>**  
**CLS<sup>®</sup>**  
complete lateral system



MaxLiner<sup>®</sup>, the industry leader in providing quick, easy and comprehensive lateral relining solutions using CIPP technology, proudly introduces MaxLinerCLS<sup>™</sup>, the Complete Lateral System for sealing lateral pipelines starting from inside the mainline and continuing out into the lateral for 10, 20, 30, or more continuous feet. MaxLinerCLS complements the already popular MaxLinerGun<sup>™</sup> which is used for rehabilitating laterals and relining vertical pipes. For more information call 877-426-5948 or visit us at [www.maxlinerusa.com](http://www.maxlinerusa.com).

**MAXLINER<sup>®</sup>**



*High Quality* **SEWER CLEANING EQUIPMENT**

Your **JETTER** comes to **LIFE** with our **UNRIVALED EQUIPMENT!**



Thanks to all our U.S. and International Customers who visited our booth at the IFAT 2008 in Munich, Germany.



FOR A DISTRIBUTOR NEAR YOU, PLEASE CONTACT:

**USB-Sewer Equipment Corporation**

DIN EN ISO  
9001:2000 CERTIFIED

1700 Enterprise Way • Suite 116 • Marietta, GA 30067 • PHONE 770-984-8880 • FAX 770-984-2802  
EMAIL [info@usbsec.com](mailto:info@usbsec.com) • WEB [www.usbsec.com](http://www.usbsec.com)



# Clean Sweep

**A sewer pipe floor-cleaning nozzle enables a New York village to keep its street reconstruction program on schedule**

By **Scottie Dayton**

**T**he Department of Public Works in the Village of Owego, N.Y., planned to reconstruct Spencer Avenue and needed the 24-inch clay sewer line running beneath it evaluated. Wastewater Superintendent Ron Horton suspected that the 80-year-old pipe, one of the oldest in the village, had problems, but the amount of sand, grit, and gravel in it prevented an inspection.

Horton and his three-man crew spent 30 hours cleaning 300 feet of the line using a 62 gpm/1,000 psi floor-cleaning nozzle. "We were going nowhere fast, and we weren't getting down to the bottom of the pipe," he says. "We had to clean and televise that line so the DPW knew what to expect and could plan accordingly."

and meet the deadline. Based on their evaluation, the DPW will reline the combination storm and sanitary sewer with cured-in-place pipe before resurfacing the street this year.

## Stubborn adversary

The Spencer Avenue line handles 40 percent of the flow from the village, and has three pump stations. A portion of the 2,100-foot pipe was cleaned in 1978 using drag buckets, but a sewer cleaning and inspection program wasn't established until four years ago. That's when the village bought a Saturn III pan-and-tilt camera on a Badger six-wheeled crawler from Aries Industries Inc., and a floor-cleaning nozzle.

"We couldn't run the camera through the clay line because debris built up under the crawler and stopped it," says Horton. "However, we did remove some car parts. I'm still shaking my head trying to figure out that one."

When the KEG nozzle arrived, the crew worked manhole to manhole. The manholes were centered



Operator Mike Lanning prepares to lower the KEG floor cleaner into the 24-inch combined sewer line.

in intersections about 300 feet apart. They cleaned upstream 20 to 30 feet, then brought the nozzle back so as not to build up a dam that would block its progress. The streets were wide enough so that lanes remained open and traffic flowed around the work crews.

"We devoted four or five hours a day to the project, working mid-morning to mid-afternoon when the flow in the line was a little less and traffic was lighter," says Horton.

Lanning unloads the debris tank at the treatment plant for proper disposal. A total of 30.3 tons was removed from 2,100 feet of pipe.



KEG floor cleaner in place and ready to begin work.

Searching for a solution, Horton contacted KEG Technologies Inc. to demonstrate its floor-cleaning nozzle for 12- to 24-inch lines. Using an above-ground test rig, Horton saw the difference in flow characteristics between his nozzle and the eight-jet, 40 gpm/1,800 psi KEG nozzle.

Horton purchased one, enabling his crew to work seven times faster

## TOUGH JOB

### PROJECT:

Clean and televise a 2,100-foot-long, 24-inch clay sewer before a scheduled street resurfacing

### CUSTOMER:

Village of Owego, N.Y.

### EQUIPMENT:

Eight-jet floor-cleaning nozzle from KEG Technologies Inc., Madison, Miss.

### RESULTS:

Pipe cleaned, inspected, and scheduled for CIPP repair; street project completed on schedule



**“The nozzle concentrates the flow at the base of the debris, lifting it up and allowing it to collapse from above. It enabled us to stay on the job and move a larger volume of material. For example, we cleaned the entire line in 30 hours, but went only 300 feet in the same time using the old nozzle.”**

**Ron Horton**



The KEG floor cleaner brings debris back to the manhole for removal by the Vac-Con's three-stage blower.

it up and allowing it to collapse from above,” says Horton. “It enabled us to stay on the job and move a larger volume of material. For example, we cleaned the entire line in 30 hours, but went only 300 feet in the same time using the old nozzle.”

The camera traveled unobstructed through the cleaned pipe, taking images of multiple longitudinal fractures, tops of broken pipes repaired with flashing and concrete, and other issues, but no root intrusion (the area has few trees). “We met our deadline and the reconstruction of Spencer Avenue is on course and on schedule,” says Horton. ■

#### Cleaning up debris

The village's 2003 combination truck from Vac-Con Inc. powered the nozzle, which cleaned 70 feet in the 20 minutes it took to empty the 1,000-gallon water tank. Excess water in the 9-cubic-yard debris tank was directed back into a manhole. After the crew refilled the water tank twice, they had to empty the debris tank at the wastewater treatment plant. The crew removed 30.3 tons of sand, grit, and gravel from the line.

“The nozzle concentrates the flow at the base of the debris, lifting

#### MORE INFO:

**Aries Industries**  
800/234-7205  
www.ariesindustries.com

**KEG Technologies Inc.**  
866/595-0515  
www.keg-pipe.com

**Vac-Con Inc.**  
904/284-4200  
www.vac-con.com

**It's A Bag Full**



**cleaner.com** 

- > Classifieds
- > Truck Stop Ads
- > E-zines
- > Product Categories

- Color Camera
- 512 Hz transmitter  
512 Hz receivers available
- Complimentary monitor  
(while supplies last)
- No more expensive down time
- 2 year guarantee
- Uses any off-the-shelf monitor
- Easily replaceable modular components
- Plumber friendly

**Starting at**  
**\$3,950**

## Easy Cam

Color Inspection Camera

### The Easy Cam Story

In 2005 two friends, one a plumber and the other an engineer, got together with the thought of improving upon the design of sewer inspection cameras. We wanted a camera that was engineered differently from the “norm”. Simplicity in our design was the answer. Our goal was to address the constant problems that cameras have which include extensive downtime, high repair costs and restricted video equipment use. We employed a common sense approach to Easy Cam resulting in a simple, sturdy camera that is dependable. Easy Cam is compatible with any off-the-shelf video equipment. Best of all, Easy Cam offers a two year guarantee with FREE replacement parts that can be installed by the owner. Easy Cam is quickly becoming the “workhorse” of the industry because Easy Cam just makes sense.

**“Thank you for your enthusiastic response.”**

Rick Joy, *Plumbing Contractor, S.W. Florida - 30 years*

Fred Lange, *Inventor of Easy Cam*

www.easycamllc.com

423.349.4300



It just makes sense

**Easy CAM™**

- ▶ Bucket Machines
- ▶ Businesses
- ▶ Business Opportunities
- ▶ Cable Machines
- ▶ Computer Software
- ▶ Dewatering
- ▶ Drainfield Restoration
- ▶ Drain / Sewer Cleaning Equipment
- ▶ Dredges
- ▶ Excavating Equipment
- ▶ Hazardous Waste Units
- ▶ Hydroexcavating
- ▶ Jetters-Trailer
- ▶ Jetters-Truck
- ▶ Jet Vacs
- ▶ Lease/Financing
- ▶ Locators
- ▶ Miscellaneous
- ▶ Parts & Components
- ▶ Pipeline Rehabilitation
- ▶ Portable Shower Trailers
- ▶ Portable Restrooms
- ▶ Portable Restroom Tanks
- ▶ Portable Restroom Trailers
- ▶ Portable Restroom Trucks
- ▶ Positions Available
- ▶ Positions Wanted
- ▶ Positive Displacement Blowers
- ▶ Power Washing
- ▶ Pressure Washers
- ▶ Pumps
- ▶ Pumps-Dredge
- ▶ Pumps-High Pressure
- ▶ Pumps-Submersible
- ▶ Pumps-Vacuum
- ▶ Pumps-Water
- ▶ Rodding Machines
- ▶ Roll-Off Containers
- ▶ Root Control
- ▶ Safety Equipment
- ▶ Septic Trucks
- ▶ Service / Repair
- ▶ Sludge Applicators
- ▶ Tanks
- ▶ Tools
- ▶ Trailers- Vacuum / Tanker
- ▶ TV Inspection
- ▶ Vacuum Loaders
- ▶ Vanes
- ▶ Wanted
- ▶ Wastewater Transfer
- ▶ Waterblasting

## BUCKET MACHINES

**USED BUCKET MACHINES,** mechanical or hydraulic, parts and accessories. Call 416-248-4990. (C9)

## BUSINESSES

**BUSINESSES WANTED:** Septic pumping, grease trap, drain cleaning and other ancillary businesses wanted. We are buying well run businesses in New England, Mid-Atlantic and Florida. All opportunities will be given proper consideration. Confidentiality ensured. Will move quickly for the right opportunity. Serious inquiries only. Please contact Richard Bedard @ Blue Water, 617-326-3344 or rbedard@bwseptic.com. (CPBM)

**FOR SALE:** 23-year-old restaurant service company specializing in hood system cleaning and ceiling restoration. Serving WV, OH and KY. Large loyal customer base. Grossing average \$500,000. All vans, equipment and experienced service techs in place. \$300,000. Will train. 304-372-2158. (CP7)

Drain cleaning, jetting, plumbing business for sale in Myrtle Beach, SC. 3 trucks, jetter, all equipment. Strong customer base. Will consider holding plumbing license. Willing to train. 843-997-5570. (CBM)

## BUSINESS OPPORTUNITIES

Mr. Rooter franchise for sale in Palm Beach County, Florida. Very tight, clean, eight truck operation. A real money maker with plenty of room for growth. Serious buyers only. 267-249-3774. (C9)

**WWW.ROOTERMAN.COM.** Franchises available with low flat fee. New concept. Visit web site or call 1-800-700-8062 x26. (CPBM)

**GREAT BUSINESS OPPORTUNITY:** Would you like to start a septic and sewer cleaning business in Florida? I have the license - will sponsor. For more information call Larry at 931-277-5541 or 931-248-1284. (CPBM)

## DRAIN/SEWER CLEANING EQUIPMENT

Used and rebuilt cable machines, cameras, water jetters and locating equipment. Ridgid K-7500, K-3800, K-1500, K-38, General Model Speed-rooter, T-3, Mini Rooter, rebuilt Spartan #1065 - \$1400; #100 - \$650. The Cable Center. 1-800-257-7209. (CBM)

**DrainCleaningSupply.com.** Sewer and drain cleaning equipment. Cable, blades and more. Rapid shipment. **DrainCleaningSupply.com.** (CP8)

## GLOVES

Brown Jersey (100% cotton), \$8.10 doz.; Case of Latex Exam Gloves, \$56.00; PVC from \$12.00/dozen. Case of Shoe Covers XL (200 pair), \$68.00. **ANY GLOVE IS AVAILABLE:** cotton, leather, PVC, latex, etc. **ASK ABOUT CONTRACTORS SPECIALS!** Metro Industrial Supply. 888-358-1923. [www.easygloves.com](http://www.easygloves.com). (CBM)

## JETTERS-TRAILER

**\$1,000 REWARD** for the recovery of a 2001 US Jetting single-axle trailer jet. Model 4014. VIN No. 1M9FS13161A044852. This stolen equipment was last reported near Ponca City, Oklahoma. If you have any information, please contact Donald Schweitzer at 251-928-8959. (CM7)

148 hours, SEWER EQUIPMENT OF AMERICA, Model 747, 600 gallons, Perkins diesel, 600' hose, 35 gpm, 2000 psi, new paint, dual axle, Florida. Email for pics: drainexpert@gmail.com. \$7,900 OBO. Call 239-340-3840. (C8)

USJ 4018-300 trailer power pullout, wireless remote, rpm 960, hp 50, psi 4000, gpm 18. Used 37 hours, 5-head pressure washer wand, 2006 model. Asking \$28,000. Call 423-595-3343. (CPT7)

1991 Ram Rodder Jetter. Myers pump. 300 gallon water tank. 4 cyl. gas motor. Hose & heads included. \$5,750. 770-443-0131. Atlanta. (CP8)

## JETTERS-TRAILER

1993 Sreco model HV2060 trailer jet, 35 gpm, 2000 psi, Myers pump, 500' of 3/4" hose, 600 gal. plastic water tanks. Was a city owned unit. 714-639-8352. [www.empireequip.com](http://www.empireequip.com). (CPBM)

2000 US Jet skid mount, dual reels, 10K, 4K, 600 gallons water, 800 hrs. Call 641-660-6991 or 641-295-6991. (C8)

New PipeHunter Model 38T44 jetting unit, trailer mounted, w/335 Poly water tank, 4,000 psi @ 25 gpm, 600' of hose and attachments. **In stock!!!** (Stock #13317) **www.VacuumSalesInc.com, (888) VAC-UNIT (822-8648).** (C7)

2 SECA trailer jets. Both have Myers 35 gpm, 2000 psi pumps. New paint on both. Located in Dallas. 972-938-1905. [www.empireequip.com](http://www.empireequip.com). (CPBM)

## JETTERS-TRUCK

1998 Vactor water jet on a Ford F-800, 17,338 miles, 65 gpm, 2000 psi pump, new paint. Truck is like new. 972-938-1905. [www.empireequip.com](http://www.empireequip.com). (CPBM)

1997 Sreco HV 2000 truck jet, 65 gpm, 2000 psi water pump, 1500 gallon aluminum water tank. Was a city owned unit. Located in Dallas. 972-938-1905. [www.empireequip.com](http://www.empireequip.com). (CPBM)

2006 Chevy C5500 with a Pipe Hunter with a Jet Eye camera and vacuum system. 1000 gallon poly tank, 50 gpm @ 3000 psi. (Stock #13234) **www.VacuumSalesInc.com, (888) VAC-UNIT (822-8648).** (C7)

## JET VACS

1994 Vactor GMC white cabover, Cummins 6 cylinder x 2, 1000 gallons - 5 yards, dual fans, excellent condition. \$70,000 OBO. Contact Bill 866-744-9921. (CP7)

2003 VacCon on Sterling chassis, new 3-stage fan, new beam, 80 gpm @ 2000 psi water pump, rotating 600' hose reel. \$100,000. James 504-628-3067. (C9)

## JET VACS

1998 VacCon 2-stage combination cleaner, single axle, 9-yd debris body, International chassis w/62K miles, 65@2000 water pump, 1000 gallon poly tanks, front 600' extension hose reel, 6' boom extension, 1700 hrs. on auxiliary diesel engine, many extras, very good machine, city owned. \$73K OBO. Call Mark @ 515-681-6321. (C7)

1996 Vactor 2110 jet vac mounted on Ford 8000 tandem axel, Allison automatic transmission, PD blower, extendible boom, rebuilt water pump. \$71,000. 559-276-0186. (CMP9)

2002 Vactor Model 2103 on an International 4700, 40 gpm, 2000 psi, **PD blower**, new white paint, **no CDL required**. Located in Dallas. 972-938-1905. [www.empireequip.com](http://www.empireequip.com). (CPBM)

1996 Vactor 2100, 12-yd tandem on Ford L8000 automatic, 2-stage fan w/1252 hrs. 1500 gallon water tanks, 80 gpm @ 2000 psi w/1215 hrs., 8' boom w/8' extension, rotating front hose reel w/dual controls, hydraulic tool hook up, 25' of tube and accessories. Very good condition, city owned. Call Mark @ 515-681-6321. (C9)

1997 Camel on Ford LNT-8000, tandem w/49K, 10-yd., PD blower, 8' extendable boom, articulating hose reel, 80@2000 water pump, 6 tube hydraulic assist rack, great shape. \$75,000. Call 319-758-7672 or 319-759-7774. (C8)

2002 Vactor 2112 on a 2002 Sterling, 80 gpm, 2500 psi, **PD blower**, new white paint. Located in Dallas. 972-938-1905. [www.empireequip.com](http://www.empireequip.com). (CPBM)

1999 International VacCon 2554 6x4 Navistar engine, Allison transmission, FMC water pump, Nordtrak aux eng. Mileage - 69,324. Hours - 3,180. Asking \$60K. Call John Sims 225-279-1487. (C7)

1991 Camel 200, 6-speed, 65 gpm, 2000 psi, Roots 624 blower, tandem axle, ready for work, 169,000 miles, excellent condition. \$46,000. Call 920-655-7302 or 920-866-9109. (CBM)

PLACE YOUR AD ONLINE AT [www.cleaner.com](http://www.cleaner.com) - IT'S ALWAYS THERE TO MEET YOUR BUSY SCHEDULE

## JET VACS

1993 Vactor 2100, 9-yd tandem on Ford L8000 automatic, single fan w/5641 hrs., 1500 gallon water tanks, 80 gpm @ 2000 psi w/4294 hrs., 8" boom w/8' extension, rotating front hose reel w/dual controls, hydraulic tool hook up, 25' of tube and accessories. Very good condition, city owned. Call Mark @ 515-681-6321. (C9)

2000 VacCon Model V311LHA on an International 2554, 3-stage fan, 50 gpm, 3000 psi pump, 11-yd. debris tank, new white paint. Located in Dallas. 972-938-1905. www.empireequip.com. (CPBM)

1981 Vactor 810, great condition, on GMC Brigadier chassis, rebuilt diesel/diesel, 2000 psi/60 gpm, new 500' hose, 35K miles. \$26,500 OBO. www.direct-current.com/vactor. Call Aaron 248-921-1910. (CBM)

2003 Sterling LT7501 with a VacCon Model VPD4216 LHA / 1300 combination vacuum-jetter unit. (Stock #4648C) **www.VacuumSalesInc.com, (888) VAC-UNIT (822-8648).** (C7)

1998 VacCon V312THA on a Ford LT8000, 3-stage fan, 65 gpm, 2000 psi pump, extendible boom, articulating hose reel, 12 yard debris tank, new paint. Was a city owned unit. Located in Dallas. 972-938-1905. www.empireequip.com. (CPBM)

VacCon model VPD4209 THA on a 1997 Ford, **PD blower**, 4200 cfm, articulating hose reel, extendible boom, new white paint. Was a city owned unit. In excellent condition. 972-938-1905. www.empireequip.com. (CPBM)

1998 Vactor 2110 on a Freightliner FL80, 28,213 miles, 2-stage fan, 80 gpm, 2,000 psi pump off system accumulator. Was a city owned unit. Located in Dallas. 972-938-1905. www.empireequip.com. (CPBM)

Low hours, 1995 Vac-Con, 12-yd. debris, new water pump, newly rebuilt Roots blower, auto. trans., AC, tank vibrator, privately owned. \$65,000. 1-800-930-1123 or 954-981-2133. (CPBM)

1994 VacCon model V311-TA, 3-stage fan, 11-yd. debris tank, 50 gpm, 3000 psi pump, new white paint. Was city owned. 972-938-1905. www.empireequip.com. (CPBM)

## JET VACS

1990 Aquatech B-10 (strong vacuum pump - new gear box), Meyers pump, 2000 psi, 80 gpm, International with automatic transmission. Price \$55,000. Call 503-969-9557 or 503-682-2723. (C7)

1987 VacCon V390TH, single axle International, DT466, auto transmission, hydrostatic drive 3-stage fan, Cummins rear engine, new Gaso 80 gpm pump, 9-yard tank, good interior, mechanical condition, needs paint. \$19,500 OBO. 228-861-5065. (C7)

2005 VacCon on International chassis, new 3-stage fan, 600' rotating hose reel, 80 gpm @ 2000 psi beam pump. \$138,000. James 504-628-3067. (C9)

Jack Doheny Supplies Inc. offers a full range of late model combo units and DOT industrial vacuum loaders. Call us @ 1-800-3DOHENY. (CPBM)

1997 VacCon V390THA on a Ford, 3-stage fan, articulating hose reel, extendible boom, new white paint. Located in Dallas. 972-938-1905. www.empireequip.com. (CPBM)

1978 Ford L-800 with Vactor 810, gas/gas, ready to work. \$9,500 OBO. Call 262-617-7061. (C7)

1989 International Camel with 7248 hours, 12-yd. debris tank, extendible boom, 1500 gallon water capacity, Meyers pump, 80 gpm, 2000 psi, ex-municipality. Price \$39,000. Call 503-969-9557 or 503-682-2723. (C7)

2005 VacCon on Sterling chassis, extendible boom, articulating hose reel. Call for price. Ken 904-993-5211 or Todd 904-434-0914. (CP7)

## LEASE/FINANCING

**North Star Commercial Credit:** Commercial Loans for Trucks or Equipment. Flexible purchase programs to fit your budget. 21 yrs. in the industry. Contact **Tom Myers - 877-804-2274.** (CPBM)

**Advertise in Classifieds for only**

**\$1.00 PER WORD!**

**at  
www.cleaner.com**

## MISCELLANEOUS

**Top quality aerators at wholesale prices.** We have replacement units for most name brands and also carry Linear Regenerative Rotary Vane pumps. Flagg Air, Gast, Thomas, FPZ, Secoh, Medo and more. Call a company that understands aerators and aeration systems. Septic Services Inc. 800-536-5564. (CPBM)

## PARTS & COMPONENTS

US JETTING provides aftermarket rebuilding services and **replacement parts for Harben® pumps.** Low prices, fast response. Why pay more? Call today. 1-800-538-8464, ext 25 or 18. (CBM)

## PIPELINE REHABILITATION

Cues TV/Cutter Trailer: 2007 Evolution package, with or without camera, cutter or compressor. Call for specs. Financing available. Kelly 608-279-2299. (CBM)

New four-inch HDPE fusion machine. Complete ready to work. 2 units available. \$2,000 each plus tax, freight. Spartan Tool, 800-435-3866. (C7)

One trade-in model of Pipe Genie heavy duty pipe bursting equipment. Excellent condition, looks new. 30-ton, 100 feet cable, full 2 year warranty. 877-411-7473. (CBM)

## PORTABLE RESTROOMS

**Portable Toilets:** Poly constructed, molded seat, urinal, latching door. Handicap accessible units available. New and used. CCI/Brian Touey 805-896-3777. (CBM)

## PORTABLE RESTROOM TRAILERS

**Restroom Trailer - Gold Series:** 32', new and used. Women's - 5 stalls, 2 sinks; Men's - 2 stalls, 2 urinals, 2 sinks. CCI/Brian Touey 805-896-3777. (CBM)

**Restroom Trailer - Platinum Series:** 30', new and used. Women's - 4 stalls, 2 sinks. Men's - 2 stalls, 3 urinals, 2 sinks. CCI/Brian Touey 805-896-3777. (CBM)

## PORTABLE RESTROOM TRUCKS

**2002 International Pumper Truck:** 4700 series, DT466, automatic, air brakes, 1200 gallon waste, 300 gallon fresh water, Masport 75 pump. CCI/Brian Touey 805-896-3777. (CBM)

2007 XL Super Duty F550, 42,000 miles, Satellite Industries tank 650/250, 17,900 GVW, like new. \$47,000. Call Sam 770-231-8498. (CP8)

2007 F-750 Super Duty flat bed, Lely Mfg. 700/300, 40,000 miles, like new. \$60,000. Call Sam 770-231-8498. (CP8)

## POSITIONS AVAILABLE

Looking to relocate to Sunny South Florida? Are you an experienced plumber or sewer and drain professional? Then you deserve to earn \$80K/year, \$5,200 bonus and a new truck and full benefits. Please call Don at 1-800-930-1123 or 954-981-2133. (CPBM)

Trenchless contractor located in SW Ohio is looking for qualified personnel with experience in cured-in-place pipe lining and manhole rehabilitation. Must be willing to travel. Competitive wages and excellent benefit package. Please call Mike H. 866-679-6800. EOE. (C7)

SBP, Inc., a Northwest Florida-based company, is seeking qualified personnel willing to travel. If you are experienced in cured-in-place pipe lining, high pressure cleaning and video and/or manhole or lift station rehabilitation using epoxy lining systems, fax your resume to 850-478-4507 to the attention of Wanda Murphy. (C7)

**ACCOUNT & PAYMENT REPRESENTATIVE NEEDED:** As part of our expansion program, Hypersco Inc. is looking for an Account & Payment Representative. It pays \$3,000 a month plus benefits and takes only little of your time. Please contact us for more details. Requirements: Should be computer literate. 2-3 hours access to the Internet weekly. Must be over 19 yrs. of age. Must be efficient and dedicated. If you are interested and need more information, contact Scot, Email: kenscot10001@aol.com. (C10)

## POSITIONS AVAILABLE

Plumbing company in Florida seeking enthusiastic class B CDL tanker endorsement licensed pump/vac truck operator. Experience preferred. Medical, 401K, holidays, vacations. 1-800-930-1123 or 954-981-2133. (CPBM)

Sales Territory Managers wanted for Dallas, Texas and Orlando, Florida markets. Very motivated, goal oriented self performers. Florida's largest cleaning contractor expanding into new markets. Please send resume via fax to 305-637-9659 or email to info@envirowastesg.com. (C9)

Spartan Tool currently has openings for Territory Managers. The successful Spartan Tool Territory Manager is an honest, self-motivated individual who is willing to get his/her hands dirty, is able to routinely travel all of the territory, resides in or very near a major metropolitan center within the territory, is mechanically adept, is able to lift 75 pounds and is customer-service oriented. Please see www.spartantool.com for more information. (CBM)

PIPE EYE is seeking qualified operator with robotics & electronics accreditation or experience for unique long range robotic pipe non-destructive examination SERVICE. Position involves: Extensive international travel (primarily US/Canada), heavy lifting, often remote and difficult conditions. Ideal candidate is a mature, strong, energetic team player with ability to think 'outside of the box' yet able to take direction. Wage: negotiable. www.pipeeyeinternational.com. Contact number 1-888-756-2033. Email: info@pipeeyeinternational.com. (C7)

Operations Manager needed for the Dallas, Tx area with the ability to run operation throughout Texas. Managerial experience is required, looking for motivated individual to run new Texas operations with the discipline to manage themselves. Must have experience managing CCTV crews, Jetter combo trucks, storm and sanitary sewer cleaning experience. Applicants can fax resume to 305-637-9659 or email to info@envirowastesg.com. Excellent salary and benefits. (C9)

IF YOU ARE USING AN

**800 NUMBER**

IN YOUR AD, BE SURE IT CAN BE USED IN ALL AREAS NATIONWIDE.

BUY IT - SELL IT - PLACE IT - **www.cleaner.com** - AVAILABLE ANYTIME, ANYWHERE, ANY DAY

## PRESSURE WASHERS

2 - Sagino high pressure washers with 150 hp electric motor driven, 300 bar/4500 psi Tri-prex pump, ss manifold and fittings, skid mount, insulated sound proof box. \$13,000 each or \$20,000 both. Call 503-969-9557 or 503-682-2723. (C7)

## PUMPS-HIGH PRESSURE

Vactor 1200 high pressure rodder pump assembly. Pump is complete with compensator assembly, water intake, outlet manifolds, and heat exchanger. Also 350 feet of 1-1/4" orange high pressure hose. The hose has one bad spot that can be repaired. Still in good shape. Make offer. Call 610-583-7462. (C7)

## PUMPS-SUBMERSIBLE

Wholesaler for Hydromatic, Zoeller, Myers, Liberty and ABS pumps. We also supply Grinder pumps and basins. Will help you size them. Septic Services Inc. 800-536-5564. (CPBM)

## PUMPS-VACUUM

Complete line of Moro, Conde and engine-driven, stand-alone pump systems, DC10 washdown pump. Call us for any of your vacuum truck parts from shut-off valves, primary and secondary valves, hoses, vacuum pumps and drive systems. Septic Services Inc. 800-536-5564. (CPBM)

## RODDING MACHINES

Sewer Equipment America Rodding Machine, trailer mounted, cutters to 14", 450+ feet 5/16 rod, diesel, complete package. \$1200. 440-967-3337. Vermilion, Ohio. (C7)

## SEPTIC TRUCKS

1999 International Eagle, 340 hp Cummins, 10 speed, 102,000 miles, 3600 steel tank, MORO pump, \$43,000. Call 772-473-3716 for details. (PT6C7)

1999 Peterbilt, 435 hp Cat, 13 spd., with new 3400 gallon vacuum tank, new Moro M10 pump, new paint and tires, exc. shape. \$65,000 OBO. 309-224-8772. (CP7)

## SERVICE/REPAIR

\*\*\*www.servicewithasmile.com\*\*\*  
**Sewer Cam Reel and Camera Repair: Authorized for General Wire, Ratech & Ridgid. Quality service on all brands. Need more info? Give Chuck a call. Electronic Repair Co., Birmingham, AL 35206. 205-836-0454; email: part@servicewithasmile.com.** (CBM)

**Sewer Cam Reel and Camera Repair:** 48-hr. turn-around time. General Wire, Ratech, Electric Eel, Gator Cams. Quality service on all brands. For more info. give Jack a call. Dynamic Cable Repairs, Lodi, NJ 07644. 973-478-0893. (CBM)

## SHOWER TRAILERS

**Shower Trailer - Gold Series:** 32', new and used. Men and women sides each have 3 private shower stalls with changing area, 1 restroom stall, 1 sink. CCI/Brian Touey 805-896-3777. (CBM)

## TANKS

1988 Presvac 3200 gallon pumper w/750 Presvac pump. Dumper, full open door, extra 750 pumps & gear boxes. Excellent condition. \$9,500 OBO. 734-365-4035. (CP7)

## TOOLS

**T&T Tools:** Probes, Hooks. Probes feature steel shafts with threaded and hardened tips. The insulated **Mighty Probe™** tested to 50,000 volts. **Top Poppers™** open manhole covers easily. Free catalog. [www.TandTtools.com](http://www.TandTtools.com). Phone **800-521-6893**. (CPBM)

## TRAILERS VACUUM/TANKER

1994 Pioneer 7500 gal. vac trailer, Fruitland pump driven by 220 V 3-phase electric motor. \$18,000. 978-423-7979. (CP8)

## TV INSPECTION

1998 Cues TV grout unit, 34,880 miles, color camera, diesel, generator. 972-938-1905. [www.empireequip.com](http://www.empireequip.com). (CPBM)

**New Cyclops Sewer Inspection System** in a good running 1993 Aerostar. Straight-view color camera, heavy duty transporter, 530' TV/tow cable, 9" color monitor/VCR combo, powered cable rewind, on-screen footage and data, DVD player/recorder and associated manhole hardware plus our famous after the sale service and support. All for the low price of \$19,500. Visit our website @ [cycloptv.com](http://cycloptv.com) or give us a call @ 830-249-9756 and talk to the guys that build 'em. (C7)

1983 GMC 1-ton with Aries/Cues TV system, pan/tilt/zoom, transporter, ready to work. \$16,000 OBO. Call 262-617-7061. (C7)

Buy direct from the factory, Pearpoint used vehicles (utility vans and step vans) with equipment, (optional) software and computers. Equipment has warranty and prices range from \$45k-\$90k. Contact Pearpoint 800-688-8094 x 245 for further details. (CMBM)

**Cyclops CCTV Sewer Inspection Systems.** New and refurbished systems in stock ready to go to work. Cyclops has what you need to start inspecting right away. P&T camera, powered cable rewind, on-screen footage and data, DVD recording, heavy duty transporter, cable lengths to 1000' and one year full factory warranty. Deal with the factory not a sales rep. Visit our website @ [cycloptv.com](http://cycloptv.com) or give us a call @ 830-249-9756 and talk to the guys that build 'em. (CM7)

## TV INSPECTION

Used and rebuilt line locators: Gen-Eye II, Rapid Detection RD-4000, Prototek ARD4, Ferris and LF2100, Ridgid Navitrack. The Cable Center. 800-257-7209. (CBM)

**EASYCAM COLOR CAMERA. FINALLY! A COMMON SENSE APPROACH TO CAMERA DESIGN.** EasyCam requires no special monitor, all parts and components are owner-replaceable. With EasyCam, there is no more expensive repair costs, no more lengthy downtime. Built tough to last. 2-year guarantee. (US & Foreign Patent Pending) **ONLY \$3,950.00. EASYCAM - "It just makes sense."** [www.easycaminc.com](http://www.easycaminc.com); 1-423-349-4300. (CBM)

Pearpoint P-147 EXPLOSION PROOF system, P-299 hydraulic cable drum, Pearpoint hexiprobe coiler, P-225 power supply, VHS, color video printer, 2 tractors, 3 cameras, Kubota diesel genset, wash down system, more spare parts, wheels etc., than you can imagine, 95 E-350 extended van w/7.3 Powerstroke, 48,000 miles, turtle-top, roof air, perfect van. \$49,950. Pictures and more info on our website: [letsrollautoandequipment.net](http://letsrollautoandequipment.net) under (vans light duty). (Colorado) Call Ned 719-338-3767. (CP7)

**Cables, Connectors & Pigtails** for all major TV Inspection Systems. Web site under construction. Jim Fowler, Oceanquip. 504-738-7833 phone/fax. (CBM)

1998 GMC Cues TV System: Approx. 1,700 L.F. of multi conductor cable, pan & tilt, Shorty transporter, washdown system, lots of storage. Good condition. Ready to work. Financing available. \$55,000. Kelly 608-279-2299. (CBM)

**REBUILT INSPECTION CAMERAS:** Gen Eye I, II, III. For more information call Jack at Dynamic Cable Repairs. 973-478-0893. (CBM)

Pearpoint Flexiview P494 color pan & tilt crawler camera, explosion proof, with motorized welded steel cable drum, 1000' kevlar reinforced cable, power supply, wheels & spacers, spare parts etc., Cdn. \$50,000. 2002 Chev 3500 ETV, 29,699 km (18,454 mi), studio & storage space, wash down system, safety lights, Cdn. \$30,000. Pictures and more info available. Call Jeremy at 416-936-6103 or [jcook@terradiscovery.ca](mailto:jcook@terradiscovery.ca). (C9)

## TV INSPECTION

**Pads and Chain Assemblies:** Silicon carbide filled for maximum traction and long life. Single and double hole pads for all makes of tractors. Money back guarantee. Contact **Pipe Tool Specialties** (503) 1-888-390-6794 or fax 1-888-390-6670. Samples sent upon request. Same day shipping. We are a 6/12 company. (CMBM)

Used and rebuilt camera kits in stock. Gen-Eye II color and black-white cameras. Push rods 131, 155, 200. Ratech 180. Pearpoint P332 color self-leveling 194. The Cable Center. 800-257-7209. (CBM)

**BEST BUY:** Must see this 1997 RST video system that includes a P & T, tractor, and an additional main-line camera. Converted ambulance with odometer of 48,000, perfect studio, storage space and safety lights. The software includes printed reports, hard disc, and Sony Photomate. Photos of interior and exterior are available via e-mail. Special Price \$24,000. Call Don at 503-969-9557. (C7)

**Wanted:** Used tractors, crawlers, straight-pan/tilt cameras, lighthoods, power controls, cables, reels, monitors, software, etc. Working or not. 902-435-8200, fax 902-435-8222. (CBM)

## VACUUM LOADERS

27" vacuum loaders, hazardous hydrovacs, reg. vacs. 780-433-1467; [www.hydrovacsunlimited.com](http://www.hydrovacsunlimited.com). (CP7)

## WANTED

Wanted to Buy: Vactor 2100's and late model Guzzlers. Cash. 800-336-4369. (CPBM)

## WATERBLASTING

Sapphire nozzles for all major 40,000 psi waterblasters at wholesale prices! Same-day shipping. UHP replacement parts, hoses. [waterjet@bellsouth.net](mailto:waterjet@bellsouth.net), 772-286-1218. (CBM)

Water jetting equipment. We rent, sell and repair water blasters. Visit us at: [www.waterjettingequipment.com](http://www.waterjettingequipment.com) or phone 714-259-7700. (CPBM)

Cleaner Magazine - For Residential, Municipal and Industrial Sewer Cleaning Contractors  
<http://www.cleaner.com/>

**Cleaner** SUBSCRIBE EDITORIAL CLASSIFIEDS VIDEO ADVERTISE

Looking to BUY or SELL?  
Just Submit Your Classified Ad ONLINE!

**Easy Secure!**

Only **\$1.00 PER WORD (\$20 Min.)**

Your ad will be posted on the Cleaner Web site within two to three business days after received.

Just go to [www.cleaner.com](http://www.cleaner.com); click on "Classifieds;" click on "Place a Classified Ad;" fill in the online form.

PLACE YOUR AD ONLINE AT [www.cleaner.com](http://www.cleaner.com) - IT'S ALWAYS THERE TO MEET YOUR BUSY SCHEDULE

**Get Results!**

Advertise in **CLASSIFIEDS** for only

**\$1.00** per word!  
(*\$20 min.*)

MUNICIPAL  
**SEWER & WATER**

**Cleaner**

**Pumper**

**CLASSIFIED AD FORM**

**PRO**

**ONSITE installer**

Please print ad legibly below with *correct punctuation* and *phone number*. Circle each word to be bolded, if any. (\$1.00 extra per word)

**CHOOSE THE CATEGORY:**

- |  |   |   |  |   |   |
|--|---|---|--|---|---|
| <input type="checkbox"/> Aerators                    | <input type="checkbox"/> Dredges                | <input type="checkbox"/> Levels & Transits        | <input type="checkbox"/> Positions Wanted    | <input type="checkbox"/> Root Control             | <input type="checkbox"/> Trailers- Vacuum/Tanker    |
| <input type="checkbox"/> Blowers                     | <input type="checkbox"/> Excavating Attachments | <input type="checkbox"/> Locators                 | <input type="checkbox"/> Pressure Washers    | <input type="checkbox"/> Safety Equipment         | <input type="checkbox"/> Trucks (dump/septic/misc.) |
| <input type="checkbox"/> Bucket Machines             | <input type="checkbox"/> Excavating Equipment   | <input type="checkbox"/> Miscellaneous            | <input type="checkbox"/> Pumps-Dredge        | <input type="checkbox"/> Septic System Components | <input type="checkbox"/> TV Inspection              |
| <input type="checkbox"/> Businesses                  | <input type="checkbox"/> Hand Tools             | <input type="checkbox"/> Parts & Components       | <input type="checkbox"/> Pumps-High Pressure | <input type="checkbox"/> Septic Tanks             | <input type="checkbox"/> Vacuum Loaders             |
| <input type="checkbox"/> Business Opportunities      | <input type="checkbox"/> Hazardous Waste Units  | <input type="checkbox"/> Pipeline Rehabilitation  | <input type="checkbox"/> Pumps-Submersible   | <input type="checkbox"/> Septic Trucks            | <input type="checkbox"/> Vanes                      |
| <input type="checkbox"/> Cable Machines              | <input type="checkbox"/> Hydroexcavation        | <input type="checkbox"/> Portable Toilets         | <input type="checkbox"/> Pumps-Vacuum        | <input type="checkbox"/> Service/Repair           | <input type="checkbox"/> Vehicle Tracking           |
| <input type="checkbox"/> Computer Software           | <input type="checkbox"/> Jetters-Trailer        | <input type="checkbox"/> Portable Toilet Tanks    | <input type="checkbox"/> Pumps - Washdown    | <input type="checkbox"/> Slide-In Units           | <input type="checkbox"/> Wanted                     |
| <input type="checkbox"/> Dewatering                  | <input type="checkbox"/> Jetters-Truck          | <input type="checkbox"/> Portable Toilet Trailers | <input type="checkbox"/> Pumps-Water         | <input type="checkbox"/> Sludge Applicators       | <input type="checkbox"/> Wastewater Transfer        |
| <input type="checkbox"/> Drainfield Restoration      | <input type="checkbox"/> Jet Vacs               | <input type="checkbox"/> Portable Toilet Trucks   | <input type="checkbox"/> Rodding Machines    | <input type="checkbox"/> Tanks                    | <input type="checkbox"/> Waterblasting              |
| <input type="checkbox"/> Drain/Sewer Cleaning Equip. | <input type="checkbox"/> Lease Financing        | <input type="checkbox"/> Positions Available      | <input type="checkbox"/> Roll-Off Containers | <input type="checkbox"/> Tools                    |   |

**CHOOSE THE PUBLICATION(S):** (Deadlines are for the month preceding issue)

- |   |   |  |
|---|---|--|
| <input type="checkbox"/> <b>CLEANER</b><br>Deadline: 1st of the Month                     | <input type="checkbox"/> <b>PUMPER</b><br>Deadline: 10th of the Month           | <input type="checkbox"/> <b>PRO</b><br>Deadline: 17th of the Month |
| <input type="checkbox"/> <b>MUNICIPAL SEWER &amp; WATER</b><br>Deadline: 1st of the Month | <input type="checkbox"/> <b>ONSITE INSTALLER</b><br>Deadline: 17th of the Month |  |

**CLASSIFIED AD RATE:**

\$1.00 per word, per month, with a 20-word minimum or \$20.  
[\$1.00 extra per bold word (key words only)]

**ADVANCE PAYMENT REQUIRED:**

No billing for classified ads. Payment must be received in advance before publishing.

**CALCULATE THE AMOUNT DUE:**

\_\_\_\_\_ words X \$1.00 = \_\_\_\_\_ X \_\_\_\_\_ Publications X \_\_\_\_\_ Months = \$ \_\_\_\_\_  
(*\$20 minimum*)      # of publications checked above      # of months to run the ad      Total Amount Due

(Example: 25-wd. ad x \$1.00 per word = \$25.00;  
\$25.00 x 2 publications [Pumper & Pro] = \$50.00;  
\$50.00 x 2 months to run the ad = \$100.00 Total)

**FILL IN COMPANY AND PAYMENT INFO:**

COMPANY NAME: \_\_\_\_\_  
 ADDRESS: \_\_\_\_\_ PHONE: \_\_\_\_\_  
 CITY: \_\_\_\_\_ STATE: \_\_\_\_\_ ZIP: \_\_\_\_\_

**MAIL** this completed form with payment to:  
COLE Publishing Inc., PO Box 220, Three Lakes, WI 54562

**FAX** this completed form to: **715-546-3786**

**ONLINE** forms at: [www.cleaner.com](http://www.cleaner.com)  
[www.pumper.com](http://www.pumper.com)  
[www.promonthly.com](http://www.promonthly.com)  
[www.onsiteinstaller.com](http://www.onsiteinstaller.com)  
[www.mswmag.com](http://www.mswmag.com)

**QUESTIONS: CALL 1-800-257-7222**

PLEASE FILL OUT CREDIT CARD INFORMATION COMPLETELY INCLUDING V-CODE (3-DIGIT NUMBER FOUND BY YOUR SIGNATURE)

CREDIT CARD NO.: \_\_\_\_\_ V-CODE: \_\_\_\_\_ EXP. DATE: \_\_\_\_\_

CARDHOLDER NAME: \_\_\_\_\_ PHONE: \_\_\_\_\_

**WE ACCEPT:**

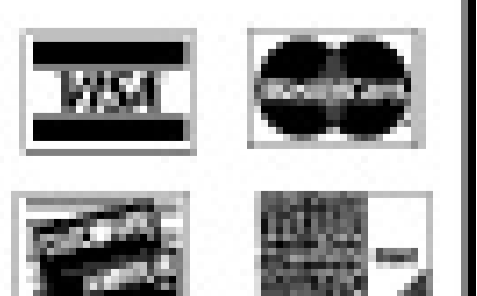

## Refrigerator MAGNETS

500 Minimum -  
Call for pricing



2-color Imprint - Quantity Discounts

### Custom Built High Flow Jetters

**Trailers, Van Kits, Portables**

13-180 HP  
4-42 GPM @ 4000 PSI  
4-72 GPM @ 2000 PSI

**AmericanJetter.com**  
**866 9HI-FLOW**

## "CUACLAW"

A Simple Solution for Slippery PVC Pipe -  
**The Right Wheels**

CALL JERRY AT 714-697-8697  
web: [www.cua-claws.com](http://www.cua-claws.com)

## Need Drain Cleaning Tools?

Economical, Fast Delivery!  
[www.plumbmatetools.net](http://www.plumbmatetools.net)

## We Make Trades Pipe Bursting Equipment

FINALLY AN EASY-TO-USE SYSTEM

SEWER • WATER • GAS LINES

Install Any Type of Pipe 1/2" to 30'  
Component Based & Light Weight  
Rugged Full Power 20-, 30-, 40-Ton Units

**New and Used Equipment**

Email: [sales@pipegenie.com](mailto:sales@pipegenie.com)  
[www.pipegenie.com](http://www.pipegenie.com)

Call Toll Free 877-411-7473

## ERICKSON Tank & Pump

**WE TAKE TRADES**

**509.785.2955**

CALL FOR UPDATED LIST OF USED EQUIPMENT

**Masport®**

PUMPS & QUALITY COMPONENTS

800 Rd. P.5 S.W. / Quincy, WA 98848  
fax: 509.785.3770  
e-mail: [sales@ericksonstank.com](mailto:sales@ericksonstank.com)  
"TANKS" FOR YOUR BUSINESS!

## T&T TOOLS T&T Tools

800-521-6893  
800-521-3260 FAX

E-mail [sales@tandttools.com](mailto:sales@tandttools.com) • [www.tandttools.com](http://www.tandttools.com)

Mighty Probe™	Handy Hook™
Sludge Hoe™	Water Probe
(insulated)	Curved Spud™
Sludge Spud™	Top Popper™
Manhole Hook	Ground Buster™
Tommy Hook™	Smart Stick™
Striking Head™	(standard)

[www.tandttools.com](http://www.tandttools.com)

## CONFINED SPACE ENTRY PACKAGE

ONLY \$3,195

The best package on the market includes:

- 4-Gas Air Monitor (3 Year Sensor Warranty)
- 7' Tripod
- 3-Way Fall Protection
- Work Winch
- Full Body Harness

Add a Blower with 15' of duct for only \$ 300!

Other Equipment Available

- Sewer Maintenance Tools
- Magnetic Lid Lifters
- Camera Systems
- Smoke & Dye Testing Items
- Blowers / Ventilators
- Vacuum Pumps and Acc.
- Aluminum Folding Ladders
- PPE
- High Pressure Water Jetters

**MTECH** 800.362.0240  
[www.mtechcompany.com](http://www.mtechcompany.com)

## Waterblaster Rentals

Houston, Texas

**Boatman Industries**

1K to 50K psi  
60 hp to 1000 hp  
Waterblasters & Accessories  
Used Equipment Sales

713-641-6006  
[www.boatmanind.com](http://www.boatmanind.com)

## CLEAN MORE FOR LESS

The "Hydro Tornado" Revolving Sewer Nozzle

- 3 Interchangeable forward jets
- 2 Revolving Jets
- 5 Rearward Jets
- 5 Thread Sizes available  
1/4" 3/8" 1/2" 3/4" & 1"
- Available from 3 thru 80 GPM

Call for prices or see our complete line of nozzles, skids and root cutters on the web at [www.breakthrumfg.com](http://www.breakthrumfg.com)

Call Toll Free 1-866-415-4655

Break Thru Manufacturing  
P.O. Box 87893  
Canton, MI 48187

## Complete Jetter Package

Plumbers - Let us improve your bottom line

13HP  
4000 PSI

**\$1,499**

Free Freight

COMPLETE DETAILS AT [www.amazingmachinery.com](http://www.amazingmachinery.com)

1-800-504-7435

## ATTRACT ATTENTION

Marketplace ads are available in color.

Call today to get started 800.994.7990

# Jetter Hose

Parker/Dayco-Piranha-Aeroquip

- 1/8" - 3000, 4800 psi
- 1/4" - 3000, 4400, 5000, 10,000 psi
- 3/8" - 3600, 4000, 5000 psi
- 1/2" - 3500, 4000, 5000 psi
- 5/8" - 4000 psi
- 3/4" - 2500, 3000 psi
- 1"-1-1/4" - 2000, 2500, 3000 psi



Call for Price & Delivery

Nozzles, Root Cutters, Clamps, Swivel Joints, Ball Valves, Hose Guides, etc.

Call for Catalog & Prices  
 Cloverleaf TOOL CO. 800.365.6583

www.cloverleaftool.com

# Save your back with the "SEWER SNAKE HANDLER"



- Electric sewer snake leader
- It is fast rugged and dependable
- Field tested for over 5 years
- Loads to curb or street
- Works with most snakes
- EZ to install for side door applications, still leaves plenty of room for access
- Locks snake secure for transport

\$1,195 plus shipping & handling batteries not included

PHONE 707-643-6002

demo video on our website  
 sewersnakehandler.com/petez2

• PIRANHA® JETTER HOSE  
 • STAINLESS NOZZLE TIPS  
 • SEWER HOSE GUIDES  
 • SWIVELS & ADAPTERS

ONE CALL AWAY...

**CAPITAL RUBBER CORP**  
 (800) 258-3000

WWW.CAPITALRUBBERCORP.COM

The **WEDGE** SE *New!*

**Trenchless Service Line Replacement!**

- Single cutting edge, reduces resistance and improves cutting capabilities!
- Minimizes property damage and street disturbance.
- Can be used with a backhoe, winch or truck.

Splits Old Copper and PE Pipe  
 While New Line is Pulled In

For More Information Call  
 1-888-737-3668

For Full Product Line Visit:  
 www.footagetools.com

**Footage TOOLS INC.**

## HOSE WAREHOUSE

A DIVISION OF **UEMSI**

Call for pricing and availability on  
 Thermoplastic Sewer Cleaning Hose,  
 Hose fittings and TygerTail™ Suction Hose

**Parker EACN EVERFLEX**  
**PIRANHA HOSE PRODUCTS**

We Accept 1.800.666.0766  
 W137N5360 Williams Place  
 Menomonee Falls, WI 53051

## SEWER CAMERAS DUCT & CHIMNEY CAMERAS HYDRO-JETTERS

Sameday & Overnight Shipping Available 1 Year Warranty

- Affordable Sewer, Chimney & Duct Cameras
- Lengths From 30' to 400'
- 16 Models to Choose From
- We Make it Simple

**120' Color Camera Complete System w/Color Monitor/VCR \$2499**

Prices Start at \$1349

**800-688-0081**  
 www.southcoastequipment.com

# STOP!

DON'T ORDER ANY MORE BIOPRODUCTS UNTIL YOU FIND OUT ABOUT BioOne®'s REVOLUTIONARY TECHNOLOGY.

Drain Line, Grease Trap, Septic System Maintenance.  
 Profitable, Easy to Sell, Simple to Use.  
 There's nothing else like it.  
 Professional strength, EPA-recognized BioOne®.

**CALL FOR A FREE SAMPLE**

**BIO One**

**800-951-4246**  
 One Biotechnology • www.1biotechnology.com

# Sewer Cam BROKEN?

- We service push rod reels, cameras and command modules. We repair most brands.
- We are an authorized service center for General Wire, Rotech, Vision and Ridgid.

..... **Electronic Repair Co.** .....

8518 First Ave. N., Birmingham, AL 35206 • 205-836-0454 • part@servicewithasmile.com  
 servicewithasmile.com/sewercam

# TrakMats™

## Ground Cover Mats

- \* Tough, Lightweight
- \* Cleats for traction
- \* Light color prevents burnt grass
- \* Hand cutouts for lifting

**800-762-8267**  
 SVE Sales, Inc. www.trakmats.com  
 Charlotte, NC 28216 email: sales@trakmats.com

## NEW IN TRENCHLESS TECHNOLOGY!

**ACP Sag Correction System**

- Remove low spots from PVC sewer lines using pneumatic powered vibration.
- No excavation required. Machine assembles in manhole.
- For Pipes 8 inch and larger.
- Can remove sags of any length.

— Advanced Construction Products —  
 Toll free 866.359.4670 | www.rerounders.com

# 10K, 20K & 36K RENTAL FLEET

Flows to 120 GPM  
 Up to 500 HP

**TRY BEFORE YOU BUY!**  
 Waterblasters and engineered accessories.  
 Rental offices in TX, FL, CA & OH.  
 Everything to meet your cleaning needs!

**GD GARDNER DENVER WATER JETTING SYSTEMS, INC.**

**CALL TOLL FREE 800-231-3628**

WWW.ROOTERMAN.COM

Franchises available with low, flat fee  
 New concept. Call 1-800-700-8062.  
**FRANCHISE PACKAGE \$7,950.**

# WATER JETS FOR RENT



- Units from 4,000 to 40,000 psi, including convertibles
- 60-600 hp, diesel or electric
- Rent, buy or lease
- Branches in MI, TX, NJ, CA, LA

**NLB Corp.** 1-877-NLB-7996  
www.nlbcorp.com

## CLEAR COMPUTING & INSIGHT

### Total Activity Control & Street Eagle GPS

#### Software for Oil and Grease Collectors

- Profit by Work-Order
- Collection Reports
- Proof of Service Documents
- GPS Tracking
- Voice Directions
- FREE Imports

“20 Years of Excellence”  
Microsoft Certified

Try it Yourself Free...  
On the Web or Your PC

(888) 332-5327  
www.clearcomputing.com

## DYE TRACERS

Solutions for:

- Infiltration
- Septic Systems
- Cross Connection
- Leaks and more...



**BRIGHT DYES**  
Division of Kingsize Chemicals

www.brightdyes.com • FAX: 937-886-9300



FREE SAMPLE 1-800-394-0678

## DYNAMIC CABLE REPAIR

We Repair:  
Gen-Eye I, II, III, GL, Electric Eel,  
GatorCams, Ratech,  
Vision Intruders,  
Inspection Cameras, Locators,  
Command Modules and Cables

48-Hr. Turn Around Time

### INSPECTION CAMERAS ARE OUR ONLY BUSINESS!

973-478-0893

DYNAMIC REPAIRS  
40 Arnot St., Unit 20 • Lodi, NJ 07644

## I & I Solutions

### INSTALL IN CLEANOUTS & MANHOLES



- Cleanouts 4" or larger
- For low flow areas
- Monitor new housing developments
- Battery operated
- An ultrasonic level measuring device

**I & I SPY**  
VISIT OUR WEB SITE  
www.twiispy.com

toll-free: 1.800.820.1321  
e-mail: info@twiispy.com

## Simple Solutions DISTRIBUTING LLC

### Wolverine Brand Vent Filters

#### Stop the Stink Guaranteed!

UPC Certified AP400 Lab Tested Model #WLV-4

Odor Adsorption Filters For: Plumbing and Septic Vents, Lift Stations, Sewer Line Vents, Manholes and Industrial Applications

Introductory Price On WLV-4 Vent Filter  
Save 25% Per Case • Save 40% On 10+ Cases



Also Available, Manhole Odor Inserts



973-846-7817  
Toll Free: 866-667-8465

www.IndustrialOdorControl.com  
www.StopSepticOdor.com



# Cleaner Marketplace

advertising Cleaner Marketplace gives you nationwide exposure to thousands of industry professionals.

Layout and design is included **FREE**, and we can fax or e-mail you a proof for final approval!

Now Available In 4-Color or Spot Colors

Choose a size that works best for you!

## Call 1.800.994.7990

<p><b>Size A: \$309<sup>00*</sup></b></p> <p>1.875" W x 4.875" H</p> <p>This size is great for two photos!</p>	<p><b>Size B: \$209<sup>00*</sup></b></p> <p>1.875" W x 3.2" H</p> <p>Perfect size for one photo!</p>
--	---

**Size C: \$109<sup>00\*</sup>**

1.875" W x 1.5" H

A great value!

\*Black and white prices, call for 4-color pricing.

Send ad materials and payment to:  
**COLE PUBLISHING INC. • P.O. BOX 220 • THREE LAKES, WI 54562**

# Cables Connectors Pigtails

for all major TV Inspection Systems

Website under construction

Jim Fowler • Oceanquip

Phone/Fax:  
**504-738-7833**

### One Complete Package

cleaner.com	eq-mag.com
promonthly.com	pumpershow.com
mswmag.com	pumpetraders.com
pumper.com	septicyellowpages.com
on-siteinstaller.com	sewerpages.com

**COLE Publishing**  
1.800.994.7990 • 715.546.3346



# Cleaner<sup>®</sup> TRUCK STOP

see photos in COLOR at [www.cleaner.com](http://www.cleaner.com)



July



**Mud Dog Hydroexcavator 2008 Sterling 9500:** Cat C13, manual, full opening tail-gate, vacuum pump 3600 cfm, Triplex water pump 10 gpm, 2000 psi, 335° boom rotation. 3 units available!  
**800-252-0043** CB



**1990 Peterbilt:** Keith Huber liquid vacuum, double vac system, 660 cfm each, 2nd pump needs rebuilding. Ready to work!  
.....\$35,000  
**251-679-8688** CPB



**1998 GMC Cues TV System:** Approx. 1,700 L.F. of multi conductor cable, pan & tilt, Shorty transporter, washdown system, lots of storage. Good condition. Ready to work. Financing available. ....\$55,000  
**Kelly 608-279-2299** CBM



**1983 Mack:** 4,000 gal. carbon steel IME tank, no pump, 200K miles, willing to separate. ....\$12,500 As Is  
**Call Ryan for Details**  
**989-233-7650** CPM7



**Shower and Restroom Trailers:** Platinum and Gold Series, new and used available. Each with separate men and women sides.  
**CCI/Brian Touey 805-896-3777** CBM



**2001 VacCon:** 11 cubic yd., 3-stage fan, remote grease station, hydrostatic, 350 gpm pump off, 500' new hose, 2001 Sterling, MD30665P, Allison auto, 300 hp Cat, 65,988 hrs., Cummins 110 hp aux. engine, 684 hrs., 51,254 miles....\$78,000  
**Frankie @ 800-527-4469** CP7



**1999 VacCon:** 44,463 mi., 15-yd. debris tank, 3-stage fan, extendible boom, equipped for hydro excavation, 80 gpm @ 3000 psi, excellent condition. **2001 GMC CCTV** Pearpoint explosion-proof system, 45,863 miles, color video, printer, tractor, excellent condition. ....Both units \$99,500  
**Call Lee 770-560-0858** P6C7



**Vac-Con V350LHA Combo Truck on 1999 Sterling L7501:** 3-stage fan, 850 gal. fresh water storage, 5-yd. debris body, telescopic boom, articulated front hose reel, hand gun wash-down system. ....\$79,900  
**Owen Equipment Co. - 800-992-3656**  
[www.owenequipment.com](http://www.owenequipment.com) CP7



**1994 Vactor GMC White Cabover:** Cummins 6 cylinder x2, 1,000 gallons, 5 yards, dual fans, excellent condition.  
.....\$70,000 OBO  
**Contact Bill at 1-866-744-9921** CP7



**1995 Ford L-8000, Vac-Con V-390:** 8.3 Cummins, John Deere diesel upper, 3-stage blower, 9 cu. yd. debris body, 37,789 miles, 1,389 hrs. vac unit, 527 hrs. jetter. ....\$47,900  
**814-696-4343 - Hollidaysburg, PA** CPM7



**1963 Trinity Stainless Propane Tank:** 9,346 gallon, converted to MC307 Vac Tanker in 1990, new Watson air ride suspension, 5 manholes on top for easy cleanout. ....\$40,000 OBO  
**989-233-7650 - Ryan for Details** CPM7



**2008 SRECO Hydro Excavator Trailer:** 99 hp diesel, 1400 cfm, 1100 gal. sectional debris/water tank, pot holing system, hydraulic boom, hydraulic door, decant.  
.....\$93,500  
**800-421-6356 - Ask for Mark** CP7



**2002 Ford E450 Video Inspection Van:** 16' cube, 7.3L V8 turbo diesel, 101,500 mi., new tires, very well maintained. RST equip., 1,821 hrs. on computer, 5,749 hrs. on Onan Quiet diesel 8000 generator, OmniEye II & OmniEye II Zoom cameras w/mainline tractor. Computer: Windows XP Pro, WinCan 7 w/NASSCO Optibase MPEG. Ready to work. ....\$62,500  
**909-422-8990** P6C7



**1990 Vactor 825:** 1000 gal. water, 10-yd. debris, PD blower, hydraulic locks & door opener, variable flow, 240 hp Ford LNT8000, partial restoration, 90% primed, rebuilt pump. Other new parts to include 500' hose. ....\$32,000  
**Frankie @ 800-527-4469** CP7



**1984 Vactor 1200:** International chassis, diesel/diesel, 12-yd. debris tank, 1000 water. ....\$10,000  
**214-212-4604** CP7



**1997 Pipe Hunter:** 30 gpm, 3,000 psi, 600' 3/4" hose, new paint, new tires, rebuilt pump. ....Make Offer  
**518-857-7420** CP7

## LMK Receives Patent for No-Dig CIPP Lateral Lining

LMK Enterprises Inc. has received a U.S. patent for its CIPP lateral lining through a cleanout without the need for digging or cutting. Lining is positioned within a translucent bladder and vacuum impregnated, inverted through the cleanout and directed by a guide shoe. The process includes the use of a camera port, which allows a lateral push camera to be inserted inside the translucent bladder, providing visual verification of liner placement prior to curing. The system allows for installation from one access point, typically from a cleanout. The liner can be cured at ambient temperatures or accelerated with steam, and remains inflated throughout the curing process. When cured, the bladder is re-inverted and removed from the pipe. For more information on the process, call 888/433-1275 or visit [www.performanceliner.com](http://www.performanceliner.com). ■

### It's black and white.

In each issue of *Municipal Sewer & Water*™, you'll read about sanitary sewer, stormwater, and water system professionals just like you. You'll discover who the innovators are and how they make their decisions. What tools and technologies drive them, and where they find the latest equipment and advice.

### No gray area here.

*Municipal Sewer & Water* has what you need. And it's **FREE**. Start your subscription today at [mswmag.com](http://mswmag.com) or call 800-257-7222.

## FSI FLUID SYSTEMS, INC.

Specializing in Parts & Service for High Pressure Water Pumps  
Used on Sewer & Catch Basin Cleaning Units



PARTS FOR PISTON & PLUNGER POWER PUMPS  
INQUIRE ABOUT PUMP TRADE-IN PROGRAM  
SHOP OR FIELD SERVICE

**1-800-880-5800**



FAX: 812-428-7061



E-MAIL: [don@fluidsystems.net](mailto:don@fluidsystems.net) • WEB SITE: [www.fluidsystems.net](http://www.fluidsystems.net)



Ever wonder why you keep "blowing" toilets and making all those little old ladies mad? We can show you how to avoid these "messy" situations, and clean more footage at the same time. Call KEG for help with your sewer cleaning tools before the news gets "splattered" all over town...not to mention all over your customers!

**Our Nozzles Don't Blow It  
When Cleaning Your Sewer Lines!**

# KEG Technologies, Inc.



Tel: 866.595.0515 Toll Free

**The Difference Is Performance!**

P.O. Box 3067  
Madison, MS 39130

[www.kegtechnologies.net](http://www.kegtechnologies.net)



What you **learn** on these pages could be worth **\$1,000s.** It's all yours for **\$1 a month\*.**

That's right. Some **25,000** of your industry peers welcome **Cleaner** every month for the value it brings to their business. Each issue shows you:

- **New tools** to help you win jobs and earn more profit.
- **Ways to save** on office expenses, supplies, advertising, taxes.
- **Money-saving** deals on equipment.
- And much **more.**

Best of all, you'll learn from **other successful business owners** – how they did it, and how you can, too.

Don't miss an issue – **subscribe today!**

\*US customers \$16 for 1 year, \$26 for 2 years, \$36 for 3 years

**Cleaner**

DEDICATED TO THE LIQUID WASTE INDUSTRY

- 1 Year (12 issues) ... **\$15.50**  
 2 Years (24 issues) ... **\$25.00**  
 3 Years (36 issues) ... **\$35.00**  
 (U.S. rates only. Call for intl. rates)

Start my subscription to Cleaner magazine.

Signature (required) \_\_\_\_\_ Date \_\_\_\_\_

Attention \_\_\_\_\_

Company Name \_\_\_\_\_

Mailing Address \_\_\_\_\_

City \_\_\_\_\_ State \_\_\_\_\_ Zip \_\_\_\_\_

Phone \_\_\_\_\_ Fax \_\_\_\_\_

E-Mail \_\_\_\_\_

**METHOD OF PAYMENT (please check one):**

- Check enclosed (payable to COLE Publishing Inc.)  
 Charge to VISA \_\_\_ MasterCard \_\_\_ Discover \_\_\_

Card # \_\_\_\_\_ V-Code \_\_\_\_\_

Cardholder Name \_\_\_\_\_ Exp. Date \_\_\_\_\_

**What is your company's primary function?** \_\_\_\_\_

**What else does your company do?** (circle letters below):

- |  |  |
|--|--|
| A TV/Video Inspection                      | M Manufacturer of _____                    |
| B Pipeline Rehabilitation/Sewer Repair     | N Septic System Design                     |
| C Drain/Sewer Cleaning (Rooting, Jetting)  | P Plumbing/Heating/Cooling                 |
| D Dealer/Distributor of _____              | Q Excavation/Grading                       |
| E Grease Pumping/Disposal/Treatment        | R Refuse (Solid Waste) Hauler              |
| F Septage or Sludge Disposal/Treatment     | S Septic Tank Service-Pumping/Maintenance  |
| G Government/Municipality/POTW             | T Portable Toilet Rentals                  |
| H Hazardous/Industrial Liquid Waste Hauler | V Industrial Plant Service Vacuum/Cleaning |
| I Septic System Installation/Repair        | W High Pressure Waterblasting              |
| J Non-Hazardous Liquid Waste Hauler        | Y Hydroexcavation                          |
| K Directional Drilling/Boring              | Z Equipment Rental Center                  |
| L Consulting                               | Other _____                                |

**Fax** this form (with payment option selected) to 715-546-3786

**Mail** this form (with payment option selected) to  
 COLE Publishing, P.O. Box 220, Three Lakes, WI 54562

**Phone** 800-994.7990 **Online** at [www.cleaner.com](http://www.cleaner.com)

C07



## A Truck Body Designed for Technician Productivity

By Ken Wysocky

**A** crammed, unorganized service truck is the bane of any technician. Wasting time searching for a part or tool and traveling back to the shop cuts into profits and causes frustration.

The Hackney Performer DC/2000 service body (P/2000 for plumbers) is designed to help create an organized and efficient environment. "With flat-rate pricing, you must have as much inventory onboard as possible," says Mike Pearson, national sales manager of special applications for Hackney, a division of VT Specialized Vehicles Corp. (VT SVC). "That way, you won't need to make extra trips and lose your profit on the job."

Measuring 84 inches wide and 12 1/2 feet long with 75 inches of headroom, the DC/2000 makes efficient use of space. The shelving setup frees space in front of the truck for larger items such as sewer machines or jettors. It can be ordered with a roll-up side door for access to hose reel storage. Two sections in the rear allow for water tank storage.

Full-width, double swing-out rear doors, which include spring rod retainers that hold them open at 90 degrees, offer easy access to storage

shelves. The shelves, 18 inches deep for drain cleaners and 23 inches deep for plumbers, are mounted on aluminum tracks and are infinitely adjustable.

"All you have to do is loosen four bolts and you can move a shelf wherever you want it," Pearson says. "Plastic storage trays rest inside the shelves like drawers in a dresser, with a one-inch retainer lip on the aisle side. Each tray has adjustable dividers that allow for up to nine compartments. There's no wasted space."

Above the shelves on each side, pipe and ladder racks provide room for 10-foot pipe sections and ladders. The truck comes with removable exterior 20-foot pipe racks. Three 7-inch dome lights provide interior lighting. A translucent ceiling is available.

"We went to a lot of trouble to make it easy to get in and out of the vehicle," Pearson says. A drop frame at the back of the chassis creates a three-step entrance. The drop frame also creates

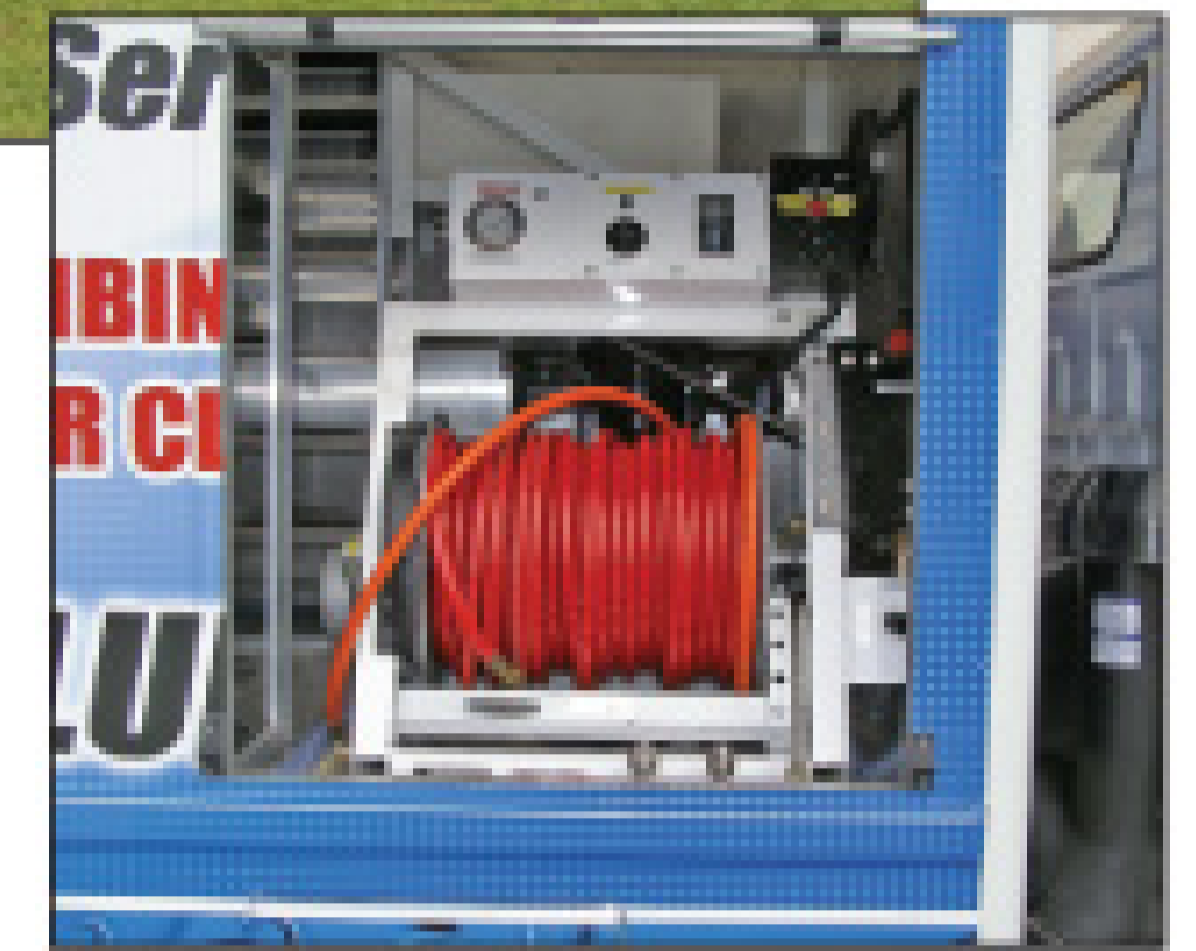

space to store a slide-out, non-skid ramp for moving heavy items.

The all-aluminum remountable body is corrosion resistant and has double-wall construction for the sides and a double-layer roof with insulation. Smooth, flat exterior side panels offer unobstructed room for graphics. "People who buy these trucks are very image conscious, so it's designed to look great going down the road, with space for real nice graphics," Pearson notes. "It's a rolling billboard."

**For information: 800/763-0700 or [www.hackneyplumbing.com](http://www.hackneyplumbing.com).**



### RIDGID Introduces Cordless Pressing Tool

The RIDGID RP 330 pressing tool is designed for compressing 1/2- to 4-inch joints and is compatible with all standard RIDGID pressing jaws. Available in both a corded (RP 330-C) and battery-powered (RP 330-B) version, the tool has a 270-degree jaw rotation and a flattened top for easier access in confined spaces. An audible signal lets the user know when the pressing cycle is complete. The cordless model

utilizes an 18-volt lithium-ion battery. Both versions come with a three- or six-jaw kit. The cordless unit also includes two batteries and charger. **For more information: 800/769-7743; [www.ridgid.com](http://www.ridgid.com).**

### Water Cannon Offers Skid-Mounted Pressure Washer

The Gator skid-mounted pressure washer from Water Cannon is available with a water tank, ranging from 50 to 200 gallons in size. The unit includes automatic engine oil level



shutdown, thermal pump protection, first-pull starting, fuel-efficient overhead valve engine, automatic decompression, lifetime aluminum frame, high-quality triplex ceramic plunger design and more. Options include a tank feed kit with external bypass assembly, drain kit, tank auto fill shutoff kit, and hose reel choices from 100, 200 and 250 feet, as well as 250-foot painted or stainless steel kits. **For more information: 800/333-9274; [www.watercannon.com](http://www.watercannon.com).**

### CUES Designs Backpack Mapping System

The CUES GPS Backpack Mapping Kit features a "hands-free" portable PC that enables field users to collect sub-meter accurate GPS coordinates, conduct asset inspections and perform data entry. The kit is designed to work with Granite XP software or an optional Granite XP ESRI module. The unit enables users to display/record sewer (manhole and lateral assets), storm, fiber and gas pipeline coordinates from a GPS receiver and transfer data to Granite XP and map their location. A Trimble ProXT receiver is included. **For more information: 800/327-7791; [www.cuesinc.com](http://www.cuesinc.com).**

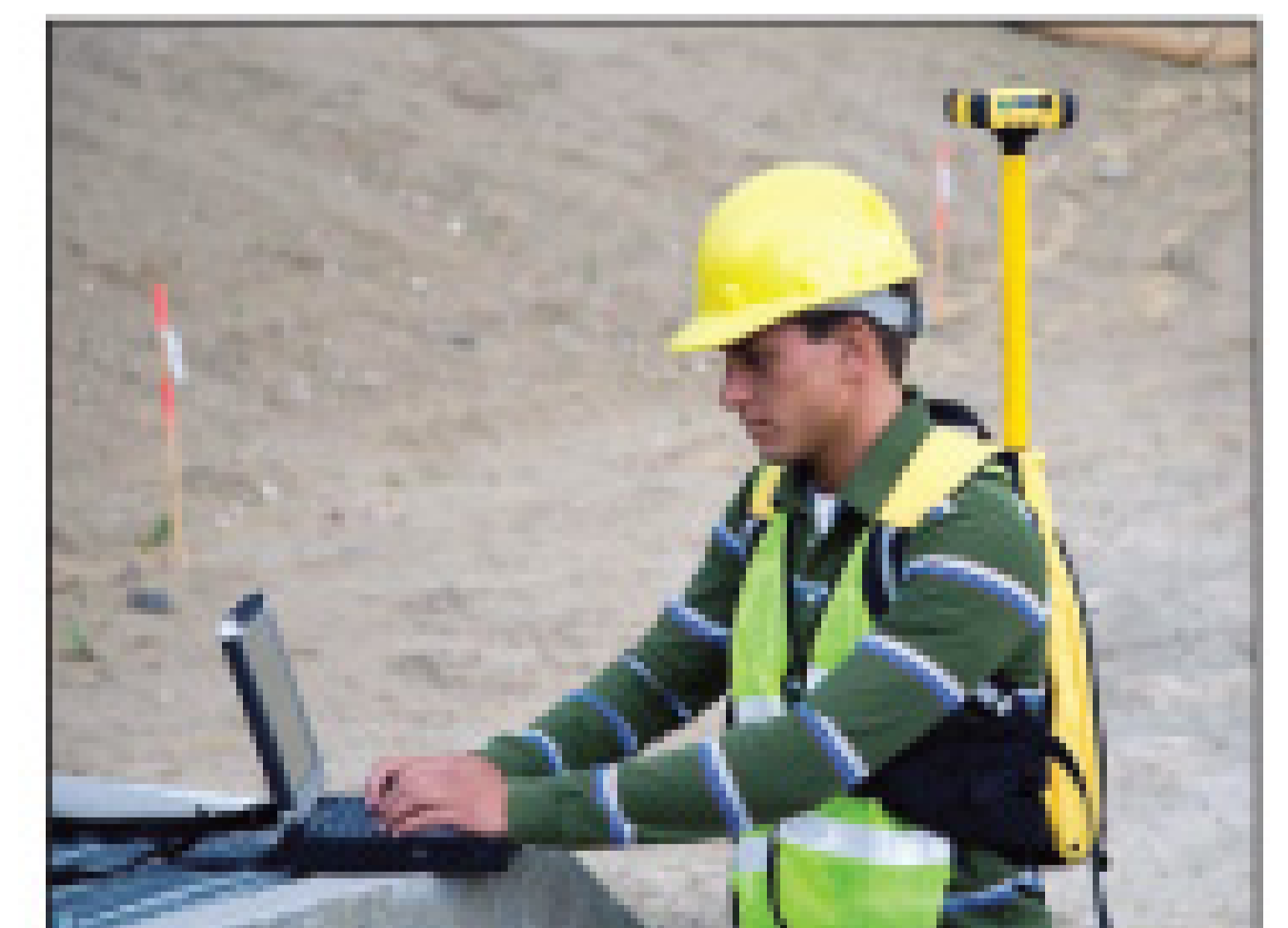



## VacAll Provides High-Performance Catch Basin Cleaners

The VacAll VC model vacuum catch basin cleaner features a 16,500-cfm blower, designed to pull muck, debris, rocks, bottles and large volumes of water from catch basins through a

rugged 12-inch diameter vacuum hose. Equipped with a 120-hp engine at 2,200 rpm, the unit delivers 372 foot-pounds of torque and has a heavy duty, two-stage air cleaner with restrictor indicator. Available in 16-, 13- and 10-yard capacities, the unit offers a 12-inch vacuum tube on all models, coupled with a hydraulically controlled rear boom with 1,000-pound lift capacity. Optional front-mounted booms are available. **For more information: 800/382-8302; www.vacallindustries.com.**

## Radiodetection Launches RD7000, RD8000 Locators

The RD7000 and RD8000 pipe and cable locators from Radiodetection are ergonomically designed, lightweight and energy efficient. The receiver and transmitter feature a high contrast, backlit LCD screen for optimal viewing in any light condition. Model RD800, with an advanced Bluetooth link and SurveyCERT reporting capability, is designed for multiple applications, while the RD7000 is designed for an industry specific application. Both models are Centros enabled. **For more information: 877/647-9495; www.radiodetection.com.**



## General Pipe Introduces Metro-Rooter Cutting Machine

The Metro-Rooter cutting machine from General Pipe Cleaners features 75 feet of 5/8-inch Flexcore wire rope center cable, engineered to handle roots and other tough stoppages in 3-inch through 6-inch lines, or can be switched to 100 feet of 1/2-inch cable for smaller jobs. The narrow profile of the lighter, compact unit facilitates handling in tight places, on stairs and during loading onto trucks. The root cutter includes a fold-down handle, truck-loading wheel and tough, lightweight frame on 10-inch semi-pneumatic wheels for easy transport. **For more information: 800/245-6200; www.drainbrain.com. ■**



35,000 OF YOUR COLLEAGUES  
READ *MUNICIPAL SEWER & WATER*™ EVERY MONTH. DO YOU?

Municipal and utility maintenance professionals rely on it for vital information on caring for vital infrastructure. Join them today.

**A subscription is FREE.**  
[www.mswmag.com](http://www.mswmag.com) or 800-257-7222



Inspiration

Information

Education

Motivation

Reprints  
Available  
Of All Cleaner® Articles

Any quantity  
Laser- or photo-quality  
8-1/2" x 11" size up to poster-size  
Electronic files

Summaries of past articles  
available at [www.cleaner.com](http://www.cleaner.com)

E-mail [sherryd@colepublishing.com](mailto:sherryd@colepublishing.com)  
or call **800/257-7222**

# SETTING THE STANDARD

MANUFACTURING THE WORLD'S MOST ADVANCED HYDRO-EXCAVATION AND INDUSTRIAL VACUUM EQUIPMENT



HV56 HydroVax



MC Series 508



MC Series 1510

RUGGED  
VERSATILE  
EFFICIENT  
DURABLE  
RELIABLE

*For Specs, check us out on the web...*



[www.gapvax.com](http://www.gapvax.com)

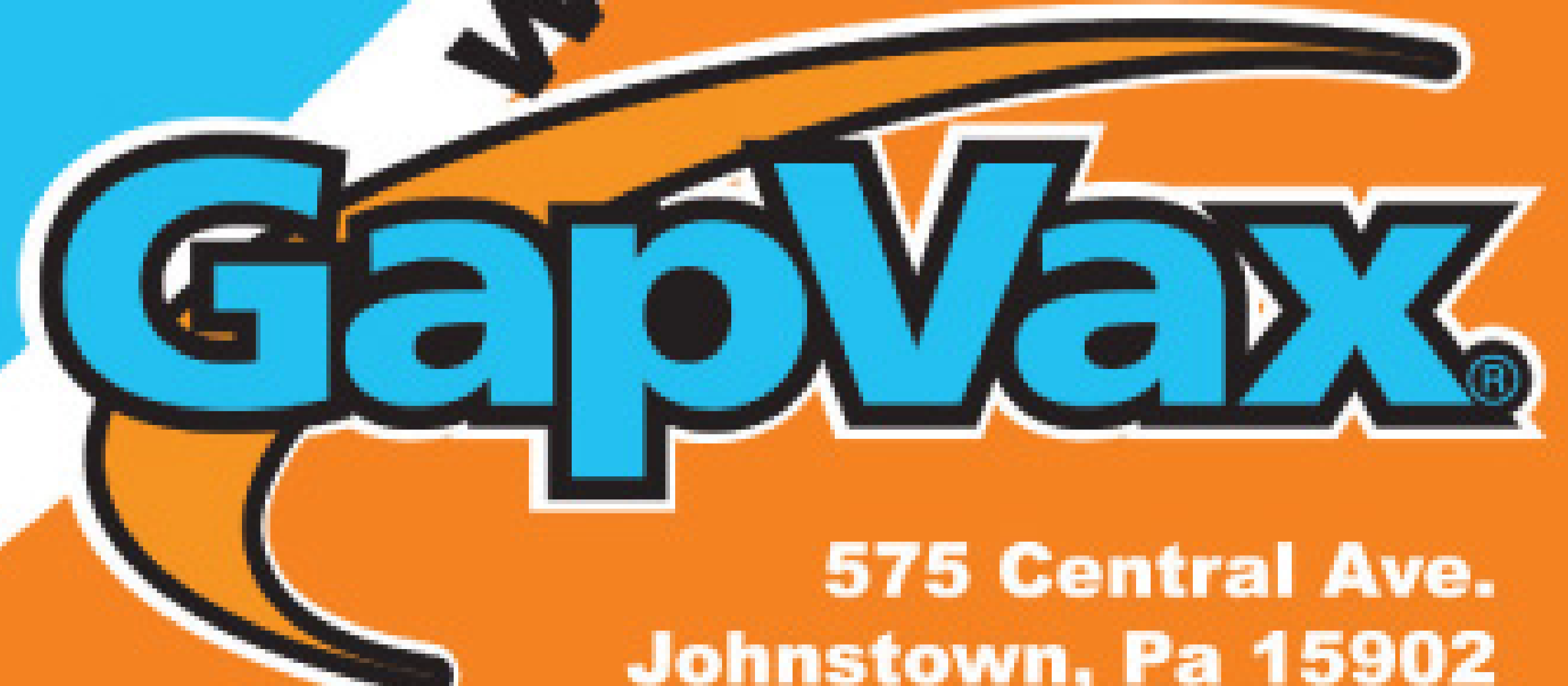

575 Central Ave.  
Johnstown, Pa 15902

toll-free U.S./Canada 888-442-7829 or 814-5235-6766/fax 814-539-3617

# NEW Model CT Drain Cleaner

# **MAXIMUM**

## Cable Control

**UNIQUE Variable Speed Motor Feature** gives the operator maximum cable control and exceptional cleaning power from 75 to 350 RPM with constant torque.

- The New Model CT Drain Cleaner is professionally engineered to clean 3/4" to 2-1/2" diameter drain lines up to 50 Ft.
- **Standard unit features a hand tighten Jacobs Chuck.** The CT is also available with a 2-way auto cable feed that keeps hands off rotating cable as it advances and retrieves cable with the push of a lever, and helps keep work area clean.
- Heavy-duty housing protects motor and internal wiring.
- Rugged stainless steel cable drum will not rust and resists denting.
- Well balanced, heavy-duty steel tubular frame allows for versatile two position operation.
- Built-in GFCI on 20 Ft. line cord protects operator from electrical shock.
- Air operated foot switch and cord assembly for ease of operation.
- Runs 1/4", 5/16" and 3/8" cable.



Patent Pending



The Counter-Top Drain Cleaner You Can Count On For Top Performance!

**1-800-833-1212**

# Electric Eel®

Drain Cleaning Tools for Professionals [www.electriceel.com](http://www.electriceel.com)

# THE WARRIOR STANDS ALONE.



**SPARTAN**  
FOR TOUGH CUSTOMERS.  
SINCE 1943

From the most trusted name in the business comes the industry's sleekest, quietest trailer jet ever. Spartan's new, fully enclosed, 4,000 PSI Warrior features exclusive soundproofing technology for engine noise below OSHA's strict standard for mandatory hearing protection. And when it comes to packing in all the power and performance you need to conquer your toughest jobs, there is no competition.



**Pop the hood:** Uncover all the hard-hitting features and specs at [spartantool.com](http://spartantool.com).

CONTACT US TODAY | 800.435.3866