

Cleaner

FOR RESIDENTIAL, MUNICIPAL AND INDUSTRIAL CLEANING CONTRACTORS



New Name, Same Face

A small-town contractor makes adjustments after taking on a national drain-cleaning franchise

PAGE 44

TECH PERSPECTIVE

The value of smoke and dye testing

READER PIPELINES

Adapting to changes in the industry

MONEY MANAGER

Keeping tabs on cash flow

Gen-Eye GL™

Pipe Inspection Location System

✓ **Check it out.**



- ✓ Self-Leveling color camera keeps the water at the bottom of the screen.
- ✓ DVD Recorder provides a crisp picture with jitter-free freeze frame.
- ✓ Gel-Rod® protects against moisture damage if rod is cut or abraded.
- ✓ Built-in full keyboard titler with eight pages of text easily shows your company name and job location.

And there's lots more; including an AC/DC converter so you can operate just with truck power, built-in voice over unit, an on-screen distance counter, and a date and time stamp.

The Gen-Eye GL system gives you all the options you need to inspect lines from 2" through 10", depending on your choice of push rod and reel size. If you're looking for a more compact monitor to fit a smaller space or budget, we've got that, too.

All this, and an honest two-year warranty as well. For more information, see your wholesaler or call the Drain Brains® at 800-235-6200 or 412-771-6300, or visit www.drainbrain.com/geneye.

General
PIPE CLEANERS
www.drainbrain.com

The toughest tools down the line.™

DO YOU HAVE THE MOST POWERFUL COMBINATION?



THE MOST POWERFUL EQUIPMENT RENTAL SOURCE NOW OFFERS
THE MOST POWERFUL COMBINATION SEWER CLEANING MACHINES WITH
HYDRO-EXCAVATING CAPABILITIES.

**Ring Power® now rents the industry-leading combination sewer cleaner made by Vac-Con.
Each comes with these great features and MORE:**

- Latest Truck Model Chassis
- 60,000 GVW/Tandem/Axles
- 300 hp Automatic Transmission
- 3-Stage Centrifugal Compressor
- Hydrostatic Blower Drive (No Clutches, Transfer Cases Or PTO's)
- 12 Cubic Yard Debris Body (2400 Gallons)
- Hydraulic Door Grabber and Locks
- 1300 Gallon Water Capacity
- High Pressure Water System (80gpm/2000psi.)
- 2000 psi. Hydro-Xcavating Package w/ 50' Retractable Handgun Reel, Extendable Wand And Rotating Nozzle
- 10' Telescoping Boom (over 26' of reach)
- Hydraulic Pump-off (400 Gpm With Gravity Drain To Front)
- 180 degree Front Mounted Articulating Hose Reel w/ 500' of 1" Hose (2500 psi)
- Debris Body Flush Out and 50' Retractable Hand Gun Hose Reels
- DOT Arrowboard, Strobe Lights

Daily, weekly, monthly rentals available. Rent today and see for yourself why Ring Power® and Vac-Con deliver one powerful combination.



Jacksonville, Florida 904-714-3517
St. Augustine, Florida 904-201-7464

ENGINEERED TO LAST

We Train Installers

We Sell Tools



MR. MANHOLE

MANHOLE LEVELING SYSTEM



PHONE: 419-229-3015 WWW.MRMANHOLE.COM

Pipeline Cleaning & Maintenance Equipment



for



JETTERS & JET VACS

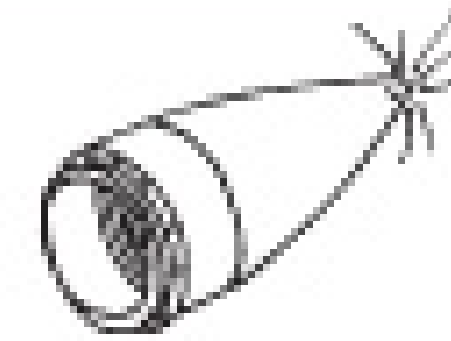

Penetrators

1/4"-15°	\$31.00
3/8"-15°	\$36.00
1/2"-25°	\$41.00
1/2"-25°LT	\$44.00
3/4"-12°	\$48.00
3/4"-12°LT	\$56.00
1"-12°	\$61.00
1"-12°LT	\$72.00



Aluminum Grease

3/4" or 1"-17° ...\$105.00

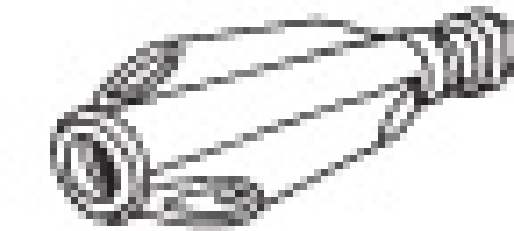

Truder

1"\$315.00



Shark

1"\$435.00
1" Big Shark.....\$555.00



Radial Bullet

1/4"-30° or 40°	\$18.75
3/8"-30° or 40°	\$21.75
3/4"-18° or 35°	\$44.00
3/4"-18°/24°	\$46.00
1"-18° or 30°	\$59.00
1"-15° or 30°	\$55.00
1-1/4"-18 or 35°	\$85.00

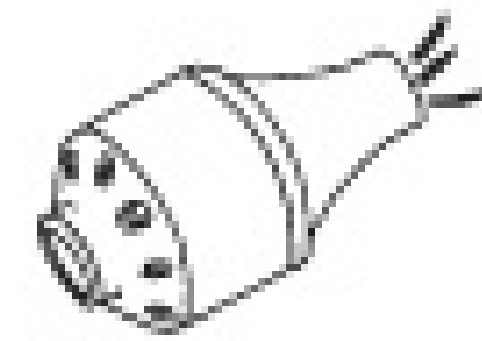

Aluminum Sand

3/4"-24°	\$125.00
1"-17°/24°	\$138.00
1"-24°	\$125.00

Stainless Steel Nozzles

1/8"	\$26.00
1/4"	\$28.00
3/8"	\$34.00
1/2"	\$48.00
3/4"	\$52.00
1"	\$92.00

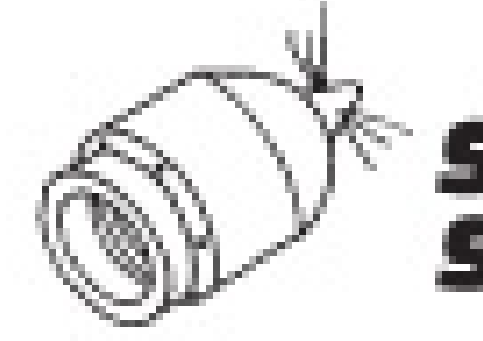

Steel Sand

1"-12°\$59.00

NEW Storm/Culvert Floor Cleaner Nozzles

MANY OTHER STYLES, SHAPES & SIZES AVAILABLE

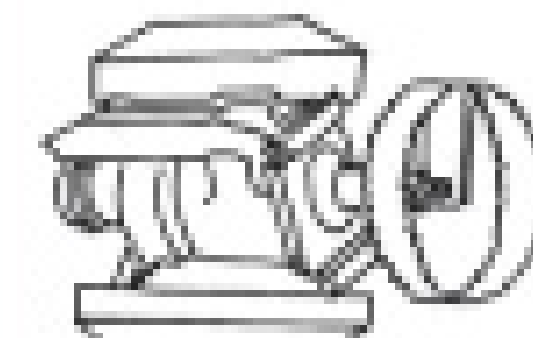

Sewer Hose Guides

TigerTail™ Style

3" x 36"	\$42.00
2" x 36"	\$34.00

with 24' rope

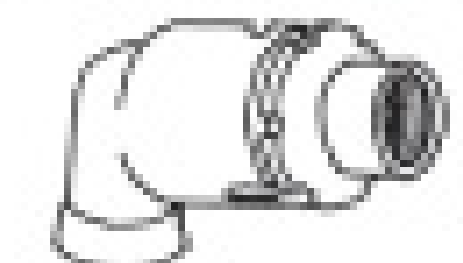

Swivel Joints

T-M® Style

90° or Straight, 6000 psi	
3/4" & 1"	\$169.00
1-1/4"	\$174.00
1-1/2"	\$432.00
2"	\$547.00

Root Cutter Assemblies

Skid Mounted	
w/flat blades	\$815.00
w/concave blades	\$850.00
w/spiral blades	\$850.00
Donut Mounted	
w/flat blades	\$790.00
w/concave blades	\$835.00
w/spiral blades	\$835.00
Lateral Mounted	
w/flat blades	\$762.00
w/concave blades	\$825.00

Assemblies come with one ea. of 6, 8, 10 and 12" blades, saw blades, hub, skids, etc.



Clamps

Power Clamps

8"\$11.00

3"-6" available

King Clamps

8"\$24.00

4"-6" available

Bandlock® Clamps

8"\$18.00

3"-6" available

Quick Clamps

8"\$21.00

3"-6" available

Ball Valves

Dyna Quip® Style, Stainless Steel, 3000 psi	
1"	\$145.00
1-1/4"	\$190.00

Hycon® Valves

2 & 3-way Ball Valves	
5000 psi	
1/2" 2-way	\$65.00
3/4" 2-way	\$89.00
1" 2-way	\$119.00
1-1/4" 2-way	\$226.00



Saw Blades

4"-18"

NEW Chain Root Cutters
4"-48", All Stainless Steel, No Lubrication



HD Washdown Gun

25 gpm @ 850 psi
1/2" Inlet\$140.00

Parker & Piranha Jetter Hose
1/8"-1-1/4"

Pipe/Sewer Plugs • Hose Reels • Aluminum Intake Tubes
Kanaflex™/Rubber Debris Hose • Full Line Of Warthog Nozzles



Toll Free: 800-365-6583
www.cloverleaftool.com

Full Catalog Online with Prices

SARASOTA, FLORIDA • PHONE: 941-739-0707 • FAX: 941-739-0001



CALL FOR OUR COMPLETE CATALOG WITH PRICES



MODEL JE-15
PORTABLE JETTER

MODEL JG-30
PORTABLE JETTER

MODEL 3010
TRAILER JETTER

www.triplerspecialty.com

For more info call:
800.356.9661

**We can handle any
jetter configuration!**

Triple R Specialty

P.O. Box 60671 • Jacksonville, FL 32236 • F: 904.786.0911

It Doesn't Compete on Price.

(Though You'd Be Forgiven for Thinking Otherwise.)

Rather, VeriSight™ delivers smart features to make you more efficient, like storage for 45 hours of MPEG4 video, multi-frequency SONDE, USB connectivity, and self-leveling head.

Despite these technological advantages, VeriSight's™ rugged design ensures dependable performance. Its welded stainless steel frame, shock absorbers and splashproof ABS controller withstand the punishment of everyday use, and its Kevlar/epoxy-reinforced push rod maintains a 4000-lb break strength.



Controller: 8" color LCD • 60 GB drive with 45-hr MPEG capacity • screenwriter with 16-page memory & QWERTY keyboard • USB 2.0 connectivity • Ni-MH battery, plus mains & vehicle power input • onscreen foot/meter counter • splashproof ABS housing



Reel: welded stainless steel construction • Kevlar/epoxy-reinforced rod with 4000-lb break strength • 3-frequency SONDE (512Hz, 640Hz, 33kHz) • available 3-frequency locator • wheels with spring shock absorbers • telescoping tow handle • 12 or 10mm rod, either 200' or 100' long

OWNER ADVANTAGE

- ▶ \$1000 EnviroSight Credit with Every System†
- ▶ 1-Year Warranty
- ▶ 7-Day Return Guarantee
- ▶ Walk-In and 24-Hour Service Plans Available
- ▶ Largest Network of Regional Service Centers

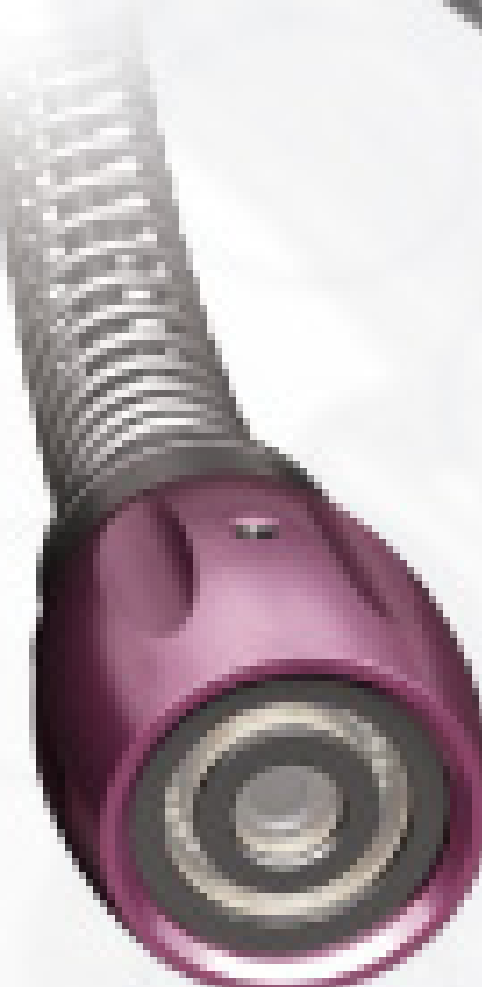

Camera: shadowless, dimmable LED array, 20% brighter than competition • self-leveling for always-upright view • stainless housing with scratchless sapphire window • 1.8" diameter with 2.4" detachable skid (4-8" adjustable skid optional) • 1.3" camera also available

VeriSight™

†Credit can be applied toward future purchases. VeriSight excluded. Offer valid until 1/1/09. The VeriSight and EnviroSight names and logos are trademarks of EnviroSight, LLC. ©2008 EnviroSight, LLC. All rights reserved. Specifications subject to change without notice.

www.envirosight.com • (866) 936-8476 • fax (973) 252-1176
Headquarters: Randolph, New Jersey • Sales & Service Offices Worldwide

EnviroSight LLC
SPECIALISTS IN PIPELINE INSPECTION



ARTICLES

44 NEW NAME, SAME FACE

By Erik Gunn

On the cover: Allen Lewerer, co-owner of Mr. Rooter Plumbing of St. Croix Valley in New Richmond, Wis., had to make adjustments when he took on the national franchise. Here, he and Kim Hudson prepare to clean a drain with a cable machine after inspecting with a MyTana push camera system. (Photography by Casey Lake)

28 BETTER BUSINESS: CHANGE IS GOOD

Here is some practical advice on how you can make your business prosper, even when the market or economy is changing and times are hard.

By Anne Houlihan

34 SUBTERRANEAN SLEUTH

Locating and inspection devices help a suburban Boston contractor solve customer's sewer pipe mysteries and build up profitable lines of business.

By Erik Gunn

60 TECH PERSPECTIVE: BRINGING LEAKS TO LIGHT

Smoke and dye testing give contractors simple yet effective tools to help communities and commercial customers find system defects.

By Scottie Dayton

REGULAR FEATURES

10 FROM THE EDITOR: BEST FACE FORWARD

Cleaning and service contractors share the logos they've developed to make an impression on customers and be top-of-mind in the market.

By Ted J. Rulseh

16 SAFETY FIRST: RISKY BUSINESS

Teaching employees to break the cycle of at-risk behavior begins with the business owner.

By Gary A. Higbee EMBA CSP

22 MONEY MANAGER: MASTERING CASH FLOW

A key to success in business is managing what comes in and what goes out. These tips can help you keep monthly income ahead of operating expenses.

By Ty Freyvogel

COMING IN MAY

Residential and Commercial Maintenance

- The latest innovations displayed at the 2008 Expo
- Profile: A \$49.95 Any Sewer or Drain Inc., Howard Beach, N.Y.
- Profile: Red Lilly Plumbing and Heating, Los Angeles, Calif.
- Safety First: Developing a fleet safety program
- Better Business: Reaching contacts with the power to say yes

72 BRAINSTORMS: GREAT GRAB!

By Jim Kneiszel

80 DEEP RECONNAISSANCE

A pipe inspection camera does duty in the follow-up to a mine disaster.

By Scottie Dayton

Subscribe to Cleaner.

... the only trade publication entirely dedicated to the sewer and drain cleaning industry, and you will be listed on www.sewerpages.com for FREE!

800-257-7222 or www.cleaner.com

68 READER PIPELINES: THEN AND NOW

Contractors explore how the industry has changed and how those changes affect the way they operate their businesses.

By Mary Shafer

82 TOUGH JOB: BESIDE THE ROAD

Horizontal directional drilling and special pipe enable installation of a new water main along a busy highway while keeping traffic flowing to businesses.

By Scottie Dayton

84 INDUSTRY NEWS

92 PRODUCT NEWS

Product Spotlight: Space-saving features mark camera inspection system.

By Ken Wysocky

Cleaner

FOR RESIDENTIAL, MUNICIPAL AND
INDUSTRIAL CLEANING CONTRACTORS

www.cleaner.com

Published monthly by
COLE Publishing Inc.
1720 Maple Lake Dam Rd.
PO Box 220
Three Lakes WI 54562

© Copyright 2008 COLE Publishing Inc.
No part may be reproduced without
permission of the publisher.

U.S. or Canada call toll-free 800-257-7222
Elsewhere call 715-546-3346
E-mail: info@cleaner.com
Web: www.cleaner.com
Fax: 715-546-3786

Office hours 7:30 a.m. - 5 p.m.
Central Time, Monday-Friday

SUBSCRIPTION INFORMATION: A one year (12 issue) subscription to *Cleaner* in the contiguous 48 U.S. states costs \$15.50 (24 issues for \$25; 36 issues for \$35). Subscriptions to Canada or Mexico cost \$27.50 per year (24 issues for \$52). Subscriptions to all other foreign countries cost \$80 per year. Subscribers are guaranteed monthly delivery of the paper. To subscribe, send company name, mailing address, phone number and check or money order (U.S. funds payable to COLE Publishing Inc.) to the address above. MasterCard, VISA and Discover are also accepted. Supply credit card information with your subscription order.

CLASSIFIED ADVERTISING: RATE: \$1 per word, per month. Minimum of 20 words or \$20. All classified advertising must be PAID IN ADVANCE. **DEADLINE:** Classifieds must be received by the first of the month for insertion in the next month's edition. **PHONE-IN ADS ARE NOT ACCEPTED.** Ads may be faxed only when charging to MasterCard, VISA or Discover. Please supply all credit card information with faxed ads. Be sure to include your phone number (with area code) in your ad. Make checks payable to COLE Publishing Inc. and mail with classified ad to the address above. **CLASSIFIED ADVERTISING APPEARS NATIONWIDE AND ON THE INTERNET.** Not responsible for errors beyond first insertion.

DISPLAY ADVERTISING: Call 800-994-7990 and ask for Jeff, Jim, Kim or Winnie. Publisher reserves the right to reject advertising which in its opinion is misleading, unfair or incompatible with the character of the publication.

CIRCULATION: Circulation averages 27,150 copies per month. This figure includes both U.S. and international distribution.



PUMPER & CLEANER ENVIRONMENTAL EXPO INTERNATIONAL

Education Day: Feb. 25, 2009
Exhibits Open: Feb. 26-28, 2009

Kentucky Exposition Center
Louisville, Kentucky
www.pumpershow.com

New!

MORE AMMUNITION FROM THE MAKERS OF ROOTX



Arm your crews with Grease-X to keep your pipelines FOG-free

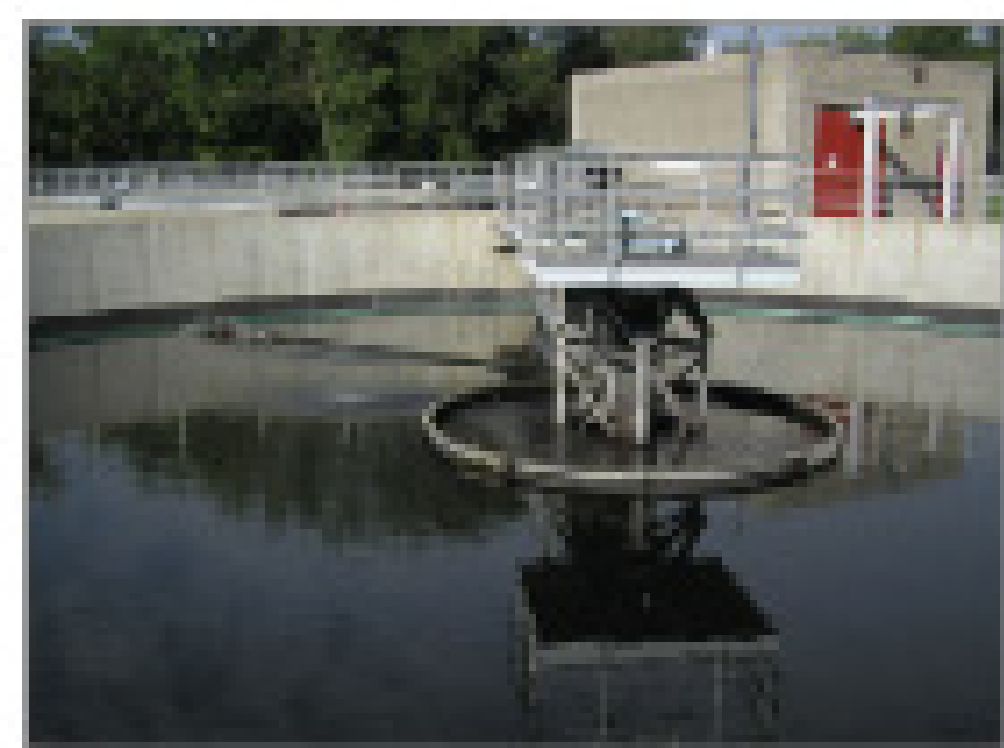

Grease-X reduces the load on your wastewater treatment plants.

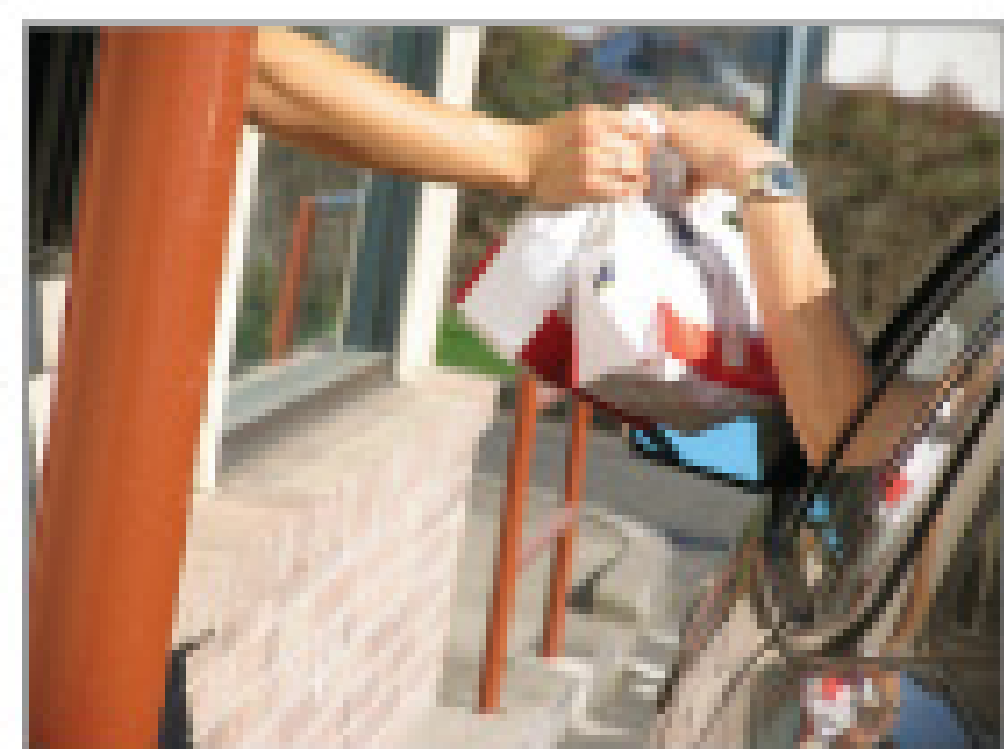

Regular treatments with Grease-X can help prevent FOG buildups—important in problem areas such as near fast-food restaurants.

Introducing Grease-X®—four powerful weapons in the battle against the fats, oils and grease (FOG) that can clog municipal wastewater systems. Grease-X gives you the power to clear FOG-choked pipelines and lift stations, prevent FOG buildup and eliminate pipeline odors using your own crews and equipment.

- **Grease-X Emulsifier**—Non-caustic, non-polluting formula penetrates and softens FOG to clear blocked lift lines.
- **Grease-X Jet**—Fast-acting emulsifier specially formulated for your jetting equipment to open blocked pipelines.
- **Grease-X Biozyme**—Highly concentrated microorganisms break down and digest FOG to keep pipelines clear.
- **Grease-X Biodeodorizer**—Digests odor-causing wastes to eliminate pipeline odors at the source.

Complete sewer system maintenance from a name you trust

You can count on Grease-X to be easy to use and effective because it comes from the makers of RootX®. Together, RootX and Grease-X



It takes just 30 minutes to treat a 400-ft. mainline with RootX.















RootX kills roots on contact and keeps them from coming back.

give you all the ammo you need to keep your wastewater system flowing smoothly.

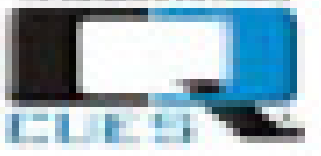
Both RootX and Grease-X are non-caustic and non-polluting—so they won't harm pipes or wastewater treatment operations. And both are easy to apply. Your crews can treat a 400-foot mainline with RootX in 30 minutes or less. FOG-choked pipelines can be cleared by simply adding Grease-X Jet to normal jetting operations. Plus, Grease-X Biozyme comes in convenient, water-soluble bags, making it easy to keep your pipelines FOG-free.

Don't wait for FOG or roots to back up your sewer system. Arm your crews with RootX and Grease-X.

**Call 800-844-4974 or visit
www.rootx.com to learn more.**

	A
Advanced Infrastructure	83
Allan J. Coleman Co.....	31, 55
Almetek Industries, Inc.	71
Amerik Engineering	73
	
Aqua Mole Technologies.....	30
	
Aries Industries, Inc.	48-89
Arthur Products	26
	B
Bowman Tool Co. & Systems	47
Bright Dyes/Div. of Kingscote	67
	C
Cable Center, The	27, 74
Cam Spray	71
	
Central Oklahoma Winnelson	52
Chem Tech Products	26
Chempure Products Corp.	18
Cloverleaf Tool Co.	4
	
Cobra Technologies	37
	
CUES, Inc.	91
	D
Drainables Direct	69
	
Duracable Manufacturing Co.	25
Dyna-Vac Equipment	64
	E
Electric Eel Mfg.	95
Environmental Products	38
	
Envirosight, LLC	5, 15
	
ENZ USA, Inc.	58

	F
Fluid Systems, Inc.	42
Flush Quip	56
	
FS Solutions	32, 33
	G
GapVax Incorporated.....	94
Gardner Denver Waterjetting	46
	
General Pipe Cleaners	2, 43
Global Pipeline Systems	75
Gorlitz Sewer & Drain, Inc.	85
Granite Leasing Co.	56
	
Guzzler Mfg. Inc.	19
	H
Hannay Reels	84
Heffernan Insurance Brokers	20
Hi-Vac Corp./Aquatech.....	63
Hurco Technologies, Inc.	81
	J
Jack Doherty Supplies, Inc.	57
	
Jetstream of Houston	17, 84
	K
KEG Technologies Inc.	42
Ken-Way Corp.....	71
KMH Equipment, Inc.	38
	L
LaPlace Equipment Company	80
Lansas Products Mfg.	52
	
Lenzyme Inc./Trap-Clear	42
Liberty Financial Group Inc.	50
Lindhorst Workhorse Nozzles	50
	M
Mongoose Jetters	53
Mr. Manhole	4
Mr. Rooter Corp.	70
	
MyTana Mfg. Company, Inc.	39
	N
NLB Corp.	41
	
Northcutt Co./Scooter Video	23

	NozzTeq
NozzTeq, Inc.	69
	P
Pat's Pump & Blower.....	58
	
Pearpoint/Radiodetection	56
	
Perma-Liner Industries, Inc.	13
	
Pipe Genie Manufacturing	65
Pipe Tools Inc.	28, 93
Piranha Hose Products	18
Poly-Flow	83
	
PrimeLine Products, Inc.	40
	
Prototek Corp.	26
	
Pulsar 2000	40
	R
RABCO	16
	
Ratech Electronics Ltd. 67, 69, 71, 73	
	
Rausch Electronics USA, LLC ...	12
Relining Technologies, LLC	9
RIDGID	21, 59
	
Ritama Technologies, LP	80
	
RootX Root Control Corp.	7
	
RS Technical Services	32
Rush Sales	14
	S
Safety Corporation of America ...	30
Sewer Equip. Co. of Florida, Inc. 30	

Sewer Equipment & Supplies	73
	
Shamrock Pipe Tools, Inc.	62
Snake Handlers	36
Soil Surgeon	73
	SPARTAN
Spartan Tool, LLC	96
Speedway Drain Cleaning Prod. ...	66
SRECO-FLEXIBLE Inc.	55
StoneAge, Inc.	24, 25
Super Products LLC	11
SVE Sales, Inc.	47
	T
T&T Tools, Inc.....	14
Toolup.com	89
Triple R Specialty	4
TRY TEK Machine Works, Inc. ...	93
	U
UEMSI	74
US Jetting, LLC	29
	
USB Sewer Equipment Corporation	12
	V
Vac-Con, Inc.	3
	
Vactor Manufacturing	51
Vacuum Sales, Inc.	20
	
Vision Technology Design & Mfg. 50	
Vivax Corp.	62
	W
Water Cannon Inc.	72
Western Sales LLC	84
Westmoor Ltd.	24
	
WinCan America, Inc.	47
WMI, Inc.	67
Wolf Creek Co., Inc.	20
Classifieds	76-79
Marketplace	86-88
Truck Stop	90



35,000 OF YOUR COLLEAGUES READ MUNICIPAL SEWER & WATER™ EVERY MONTH. DO YOU?

Municipal and utility maintenance professionals rely on *Municipal Sewer & Water*. They get vital information on caring for vital infrastructure: sanitary sewer systems, storm drainage systems, and drinking water distribution networks. Join them today. Stay current with the latest tools and methods for cleaning, testing, inspection, surveying, repair and rehabilitation.

A subscription is FREE.
www.mswmag.com or 800-257-7222



PLUMBING CONTRACTORS



INCREASE YOUR BOTTOM LINE.

With An **Easy Liner** System, Offering CIPP Lining Services to Your Customers Has Never Been Easier or More Profitable!

Relining Technologies, the national distributor of Easy Liner CIPP products and equipment provides contractors complete turn-key solutions to get involved in the fastest growing and greatest profit generating segment of the plumbing market.

- Rehab 2" to 12" diameter lines
- Applied from the clean out
- Minimal disruption
- Cures in just over 1 hour
- Installed within 1-2 hours
- Custom-built lining rig to fit your needs and budget
- Retrofits of your existing equipment available
- Financing available

Since adding 2 Relining Technologies trucks to our fleet, we've increased our revenue over \$600,000 per month.

-- Jeff Stanley, President
Rapid Plumbing Inc., California

Let Relining Technologies show you how to achieve similar results. Call today.



 **Relining
Technologies**

CONTACT: 800 496 1498

www.reliningtechnologies.com

NO franchise or territory fees!!!

Best Face Forward

Cleaning and service contractors share the logos they've developed to make an impression on customers and be top-of-mind in the market

Ted J. Rulseh



American eagles, exploding toilets, poker hands, elephants, chess pieces, even plumber caricatures. That's what we got after asking cleaners last December to share their company logos. It's clear there is no shortage of creative talent in the industry.

The owners say these logos help them stay top-of-mind with customers. That's the whole idea — a symbol customers not only recognize when they see it on a passing truck but remember when they need help and are cruising the Yellow Pages. Here is a closer look at several of the logos sent our way.

Federal Piping Co. Inc., Freedom, N.H. David Boyd set up his business in Freedom in 1991, a newcomer competing mostly with one-man shops having close ties to the community. His eagle logo helped him get noticed and, after half a dozen years, gain a strong foothold in the business. A separate version for his sewer and drain division shows the eagle holding a bucket and plunger.

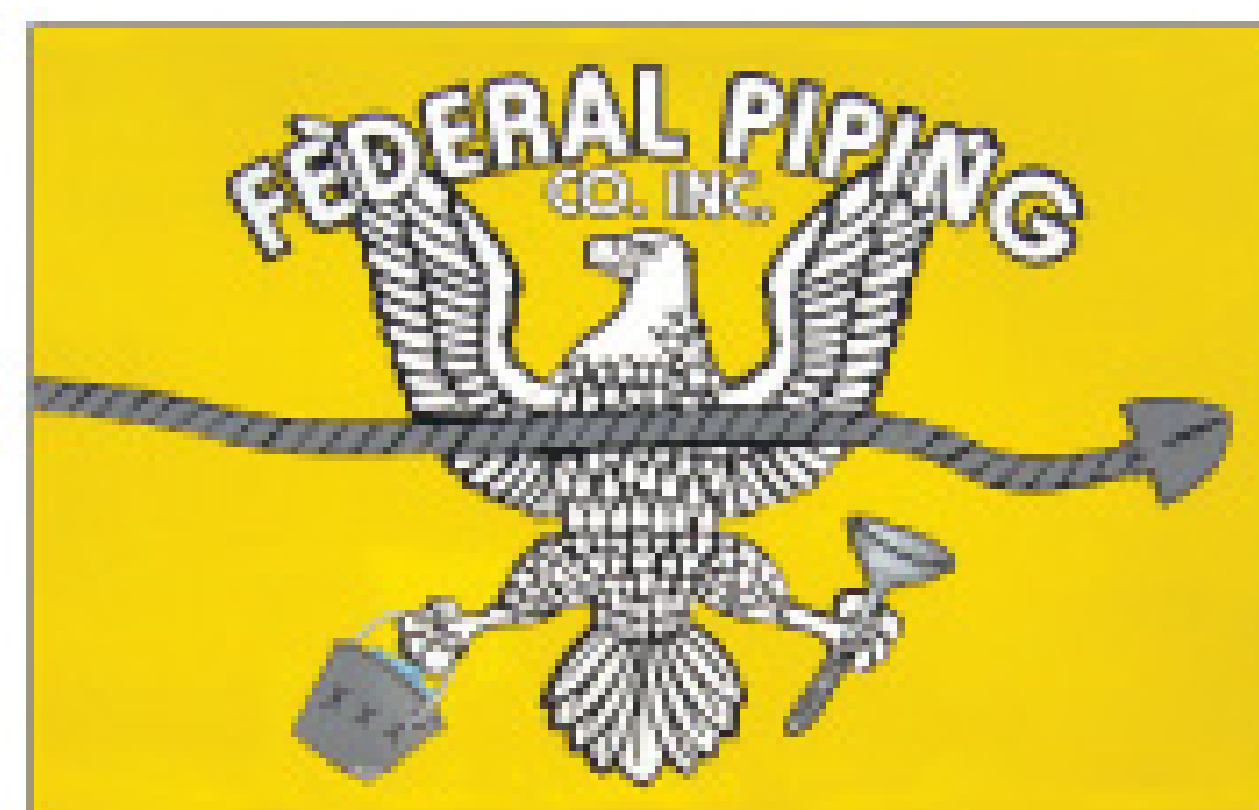

Boyd, who used to make pen-and-ink drawings of wildlife as a hobby, designed and created the logo himself. "I wanted something that would say, 'America,' he says. Today, the logo, displayed in yellow on black trucks, is widely recognized.

When In Distress...



Call

DrainXpress
Sewer and Drain Cleaning

24/7 Emergency Drain Relief

1-877-DRAIN-01

DrainXpress, Philadelphia, Pa. Owner Donat Houle (pronounced da-NAY HOOL), came up with the logo with help from his wife, Mary, and a local graphic designer. When they started in business in June 2006, they just used the DrainXpress name underlined by the cleaning tool. Last January they added the spouting privy.

"We offer 24-hour emergency drain relief, and we wanted to convey that idea to our customers," Houle says. "I came up with the exploding toilet and took it to a graphic designer to give it a professional touch." The presentation clearly displays a toll-free number that should be easy for customers to remember.

Royal Flush Plumbing Inc., Seekonk, Mass. You can almost guess the slogan a company by this name would use. "A royal flush beats a full house" — ever hear that one before? This company takes a clever and more interesting approach.

Its slogan, "The Best Hand in the Game," relates back to the company name and the hand of cards held by the pipe wrench. But it also speaks to professionalism: Call this company and an expert comes to your house. Royal Flush has been in business since 1992.

Company representative Jane Watson says the firm created the new logo last year, with help from a graphic designer.



Scheer Inc., Grafton, Wis. A logo for a drain cleaning company doesn't have to show nozzles, snakes, toilets or drains to be effective. It just has to get attention and be memorable in some way. This logo, in bright blue and red, certainly catches the eye.

"We are a home repair and maintenance company that does many sewer, drain cleaning, and sewer televising jobs," says company representative Jason Scheer. "We started with two trucks and an enclosed trailer, and we are now setting up a box truck dedicated to just sewer and drain cleaning and televising." You can bet that truck will carry the Scheer logo.

Royal Rooter Sewer & Drain, Coventry, Conn. Owner Jeff Harrell observes, "My tagline has been, 'We clean your drain, NOT your wallet,'



**ROYAL ROOTER
SEWER & DRAIN**

WE CLEAN YOUR DRAIN...
NOT YOUR WALLET.

"We offer 24-hour emergency drain relief, and we wanted to convey that idea to our customers. I came up with the exploding toilet and took it to a graphic designer to give it a professional touch."

Donat Houle
DrainXpress
Philadelphia, Pa.

"When you create an identity, you have to stay with it," says Boyd. He gives T-shirts bearing the logo to regular customers. A few have sent him pictures of themselves wearing the shirts in front of tourist landmarks.

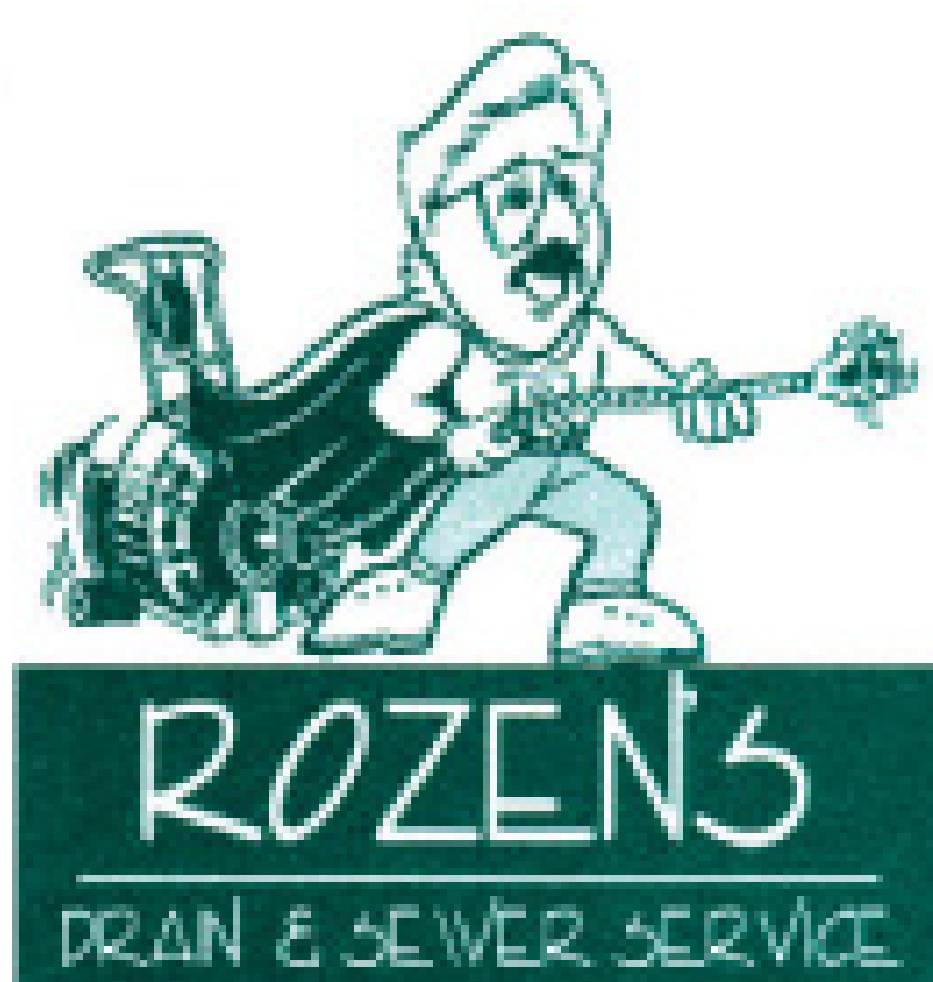

"WE CLEAN OUT YOUR DRAINS...
NOT YOUR POCKETS!"

Rozen's Drain & Sewer Service, Binghamton, N.Y. Residents of Binghamton may recognize the superhero plumber — its owner Hershey Rosen himself. Those who see the emblem may also remember what Rozen's does and doesn't clean. John Bon Fed, a friend of Rosen who is a caricaturist, created the logo, which the company has used for years. "The only difference is that my hair is gray now," Rozen says.

“They put the word ‘drain’ in blue for water and the word ‘medic’ in red for emergency. “Then they put the EKG trace across the top. When we saw that, we were hooked.”

Greg Arnold
Drain Medic
Levittown, Pa.

for seven years, and my customers love it.”

Drain Medic, Levittown, Pa. Owner Greg Arnold knew emergency service as a volunteer firefighter for 13 years. His wife is a nurse. So when it came time to start his drain cleaning company just over a year ago, the name Drain Medic was a natural.



had in mind a red cross with a plunger across it. Knowing he needed help, he sought out a logo company on the Internet.

“They put the word ‘drain’ in blue for water and the word ‘medic’ in red

“We wanted a logo that would stand out,” he says. “We wanted it to be professional, not cartoony.” Arnold

for emergency,” says Arnold. “Then they put the EKG trace across the top. When we saw that, we were hooked.”

A-K Underground, Tinley Park, Ill. This company’s logo says “vacuum power.” The look on that elephant’s face tells you he means business. A-K specializes in pipe cleaning, vacuuming and jetting, and its brochure prominently features a green combination truck with the logo emblazoned on the sides. “We have had this logo for several years, and it seems to work for us,” says owner Al Kulig. “The credit for it has to go to my son, Greg.”

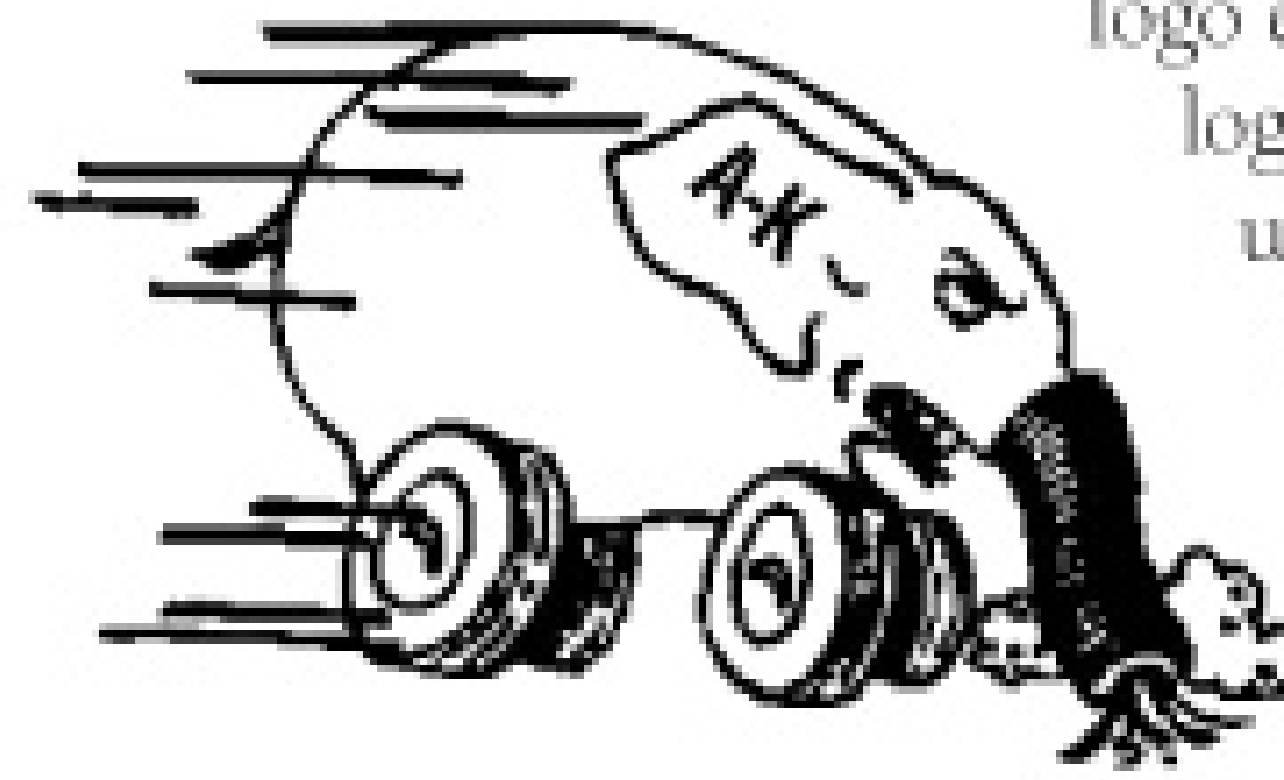

So, there’s an assortment of logos from independent cleaning companies. Each has its merits. Maybe each could be improved in some way. The important thing is that they seem to serve their purpose: to make the company stand out from competitors.

Perhaps you’ve learned a tip or two from these creative business owners. And maybe one key take-away is that you yourself don’t have to be creative — there are plenty of good design shops available, wherever you may be.

The real lesson, though, is more basic. If you don’t have a memorable image for your business, start now to create one. Give your customers a way to remember you. ■



You Can See The Results

Super Products

Worldwide Vacuum Technology
Since 1973



Camel®
with Camera option



800-837-9711
www.superproductscorp.com

YOU DESERVE THE BEST!

RAUSCH Pipe Inspection Equipment!

The most unique combo on the market!

Mainline & Lateral inspection with Lateral jetting launching from the Mainline - using the same system!

- Most cost efficient system on the market: one man operation!
- Both mainline & lateral cable drums are synchronized and motorized!
- Low maintenance cost!
- Most versatile system on the market today!

RAUSCH offers a wide variety of system combinations based on your changing business demands.

PLUS optional upgrades and customized installations.

For more information call our office or visit our website at www.rauschtv-usa.com.



- Mainline & Lateral Inspection
- Lateral Jetting
- Point Repair
- Pressure Testing
- Profiling

Thanks for visiting us at the
2008 Pumper & Cleaner Show!



TSS200 Lateral Jetter

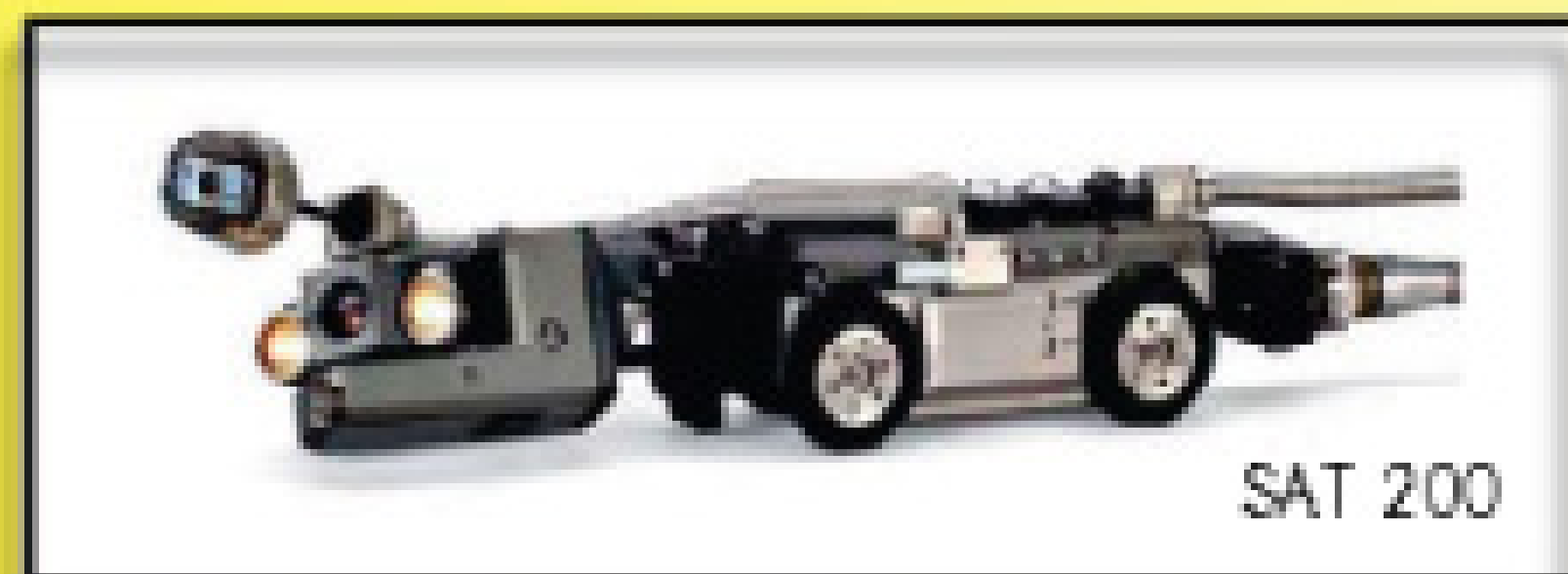

SAT 200

RAUSCH Electronics USA, LLC (REUSA)

370 New York Avenue

Chambersburg, PA 17201

Email: reusa@rauschtv.com

Call (877) 728-7241



High Quality SEWER CLEANING EQUIPMENT

Your **JETTER** comes to **LIFE** with our **UNRIVALED EQUIPMENT!**

USB-SEWER EQUIPMENT CORPORATION proudly DEVELOPS and DISTRIBUTES innovative, unrivaled sewer cleaning equipment, precision manufactured in Germany and The Principality of Liechtenstein to the highest technical standards. These products are leaders in the industry and include **NOZZLES, TURBO CHAIN CUTTERS, MILLING CUTTERS, SPECIALTY TOOLS** and **ACCESSORIES** for the municipal and industrial markets.



USB-SEC NOZZLES

with Optimized
3D Hydro Mechanics™

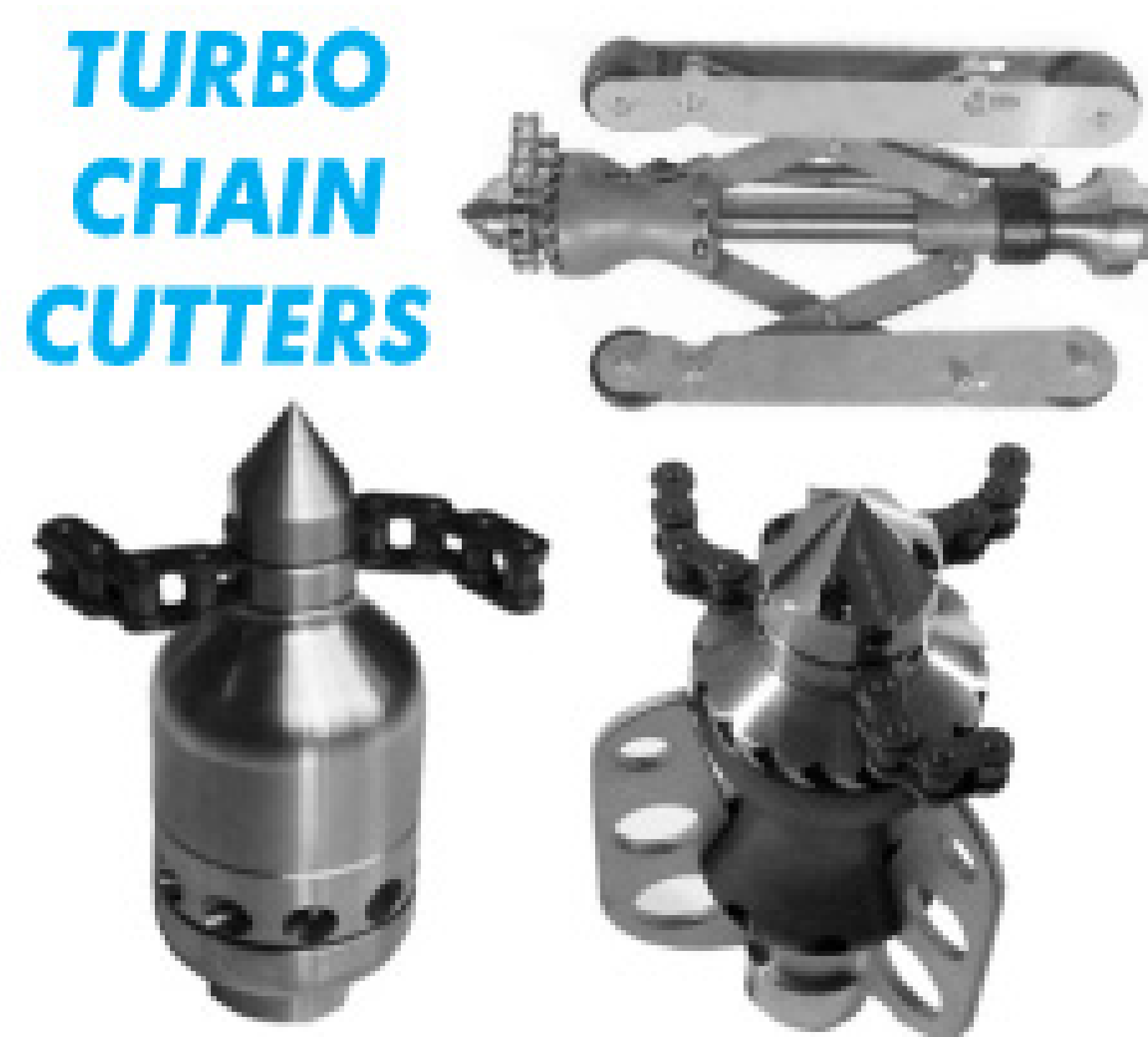

TURBO CHAIN CUTTERS



MILLING CUTTERS



SPECIALTY TOOLS



FOR A DISTRIBUTOR NEAR YOU, PLEASE CONTACT:

USB-Sewer Equipment Corporation

1700 Enterprise Way • Suite 116 • Marietta, GA 30067 • PHONE 770-984-8880 • FAX 770-984-2802

EMAIL info@usbsec.com • WEB www.usbsec.com

PERMA-LATERAL™ LINING SYSTEM

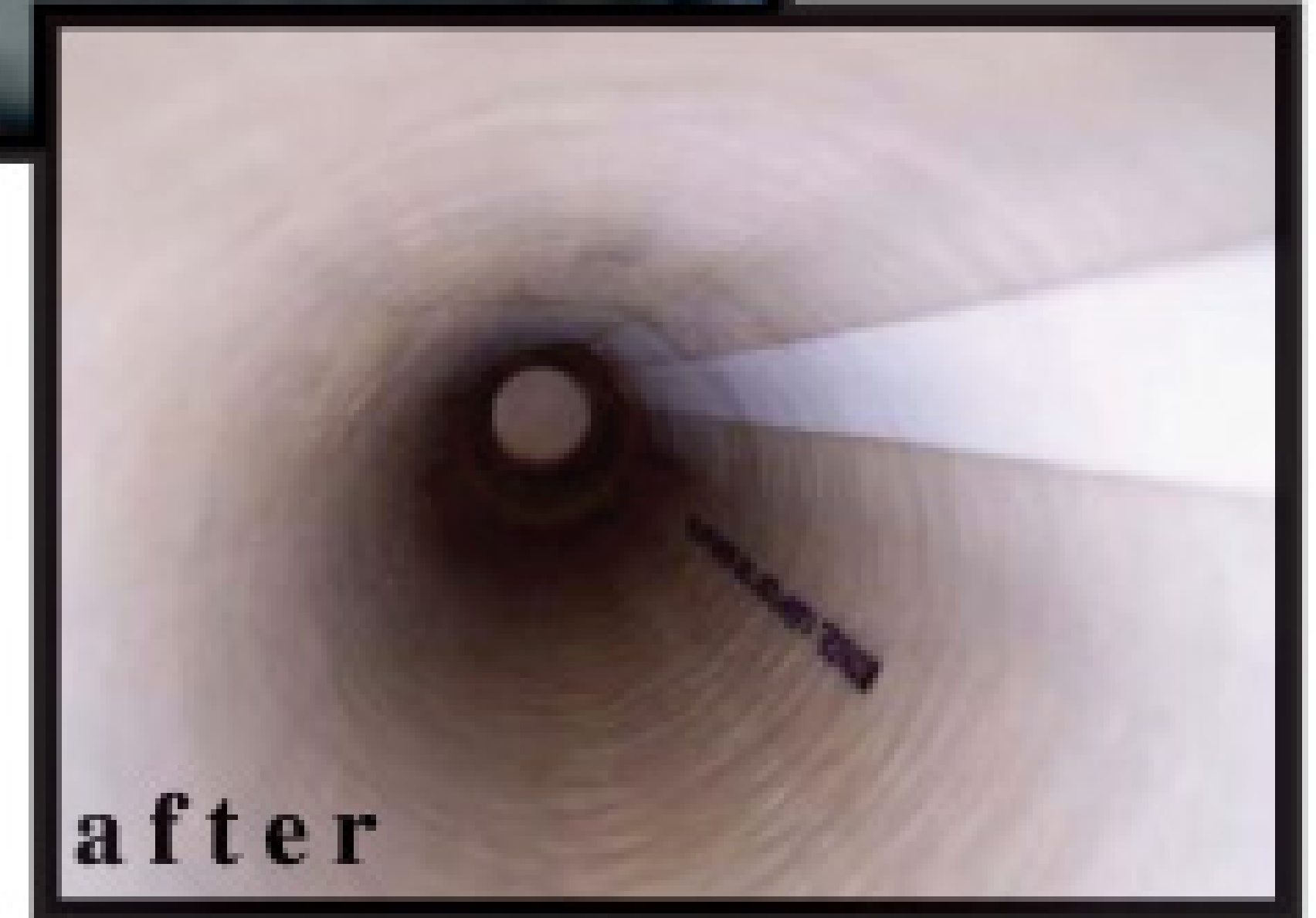
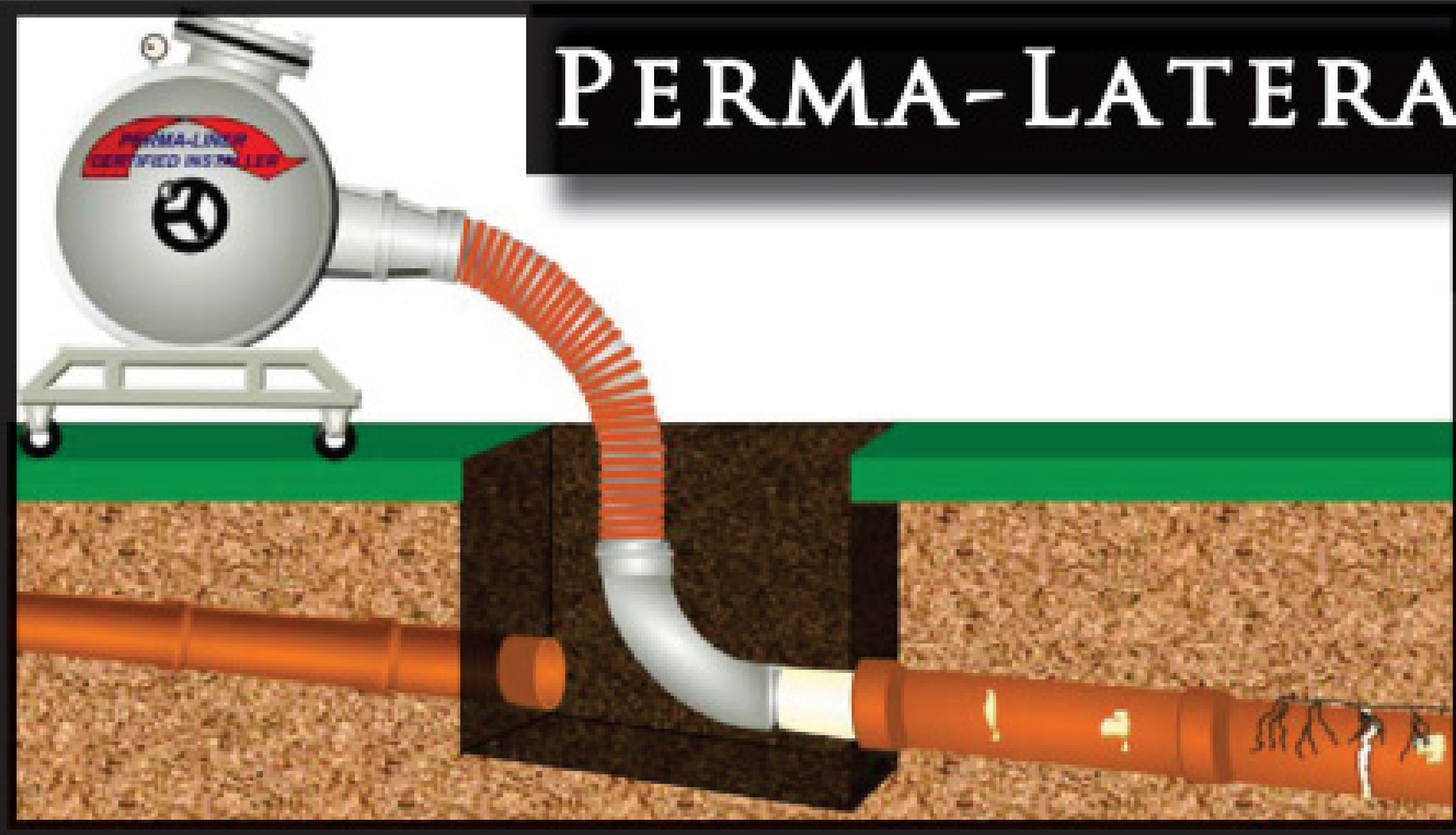

- Liner Cures Without External Heat Source
- NSF and IAPMO Certified
- Permanently Stops Root Intrusion
- Seamless/Jointless From Beginning to End

WWW.PERMA-LINER.COM

COME VISIT US FOR OUR OPEN HOUSE: MAY 14TH, 15TH & 16TH



VISIT US ON THE WEB TO LEARN
MORE ABOUT OUR "TURN-KEY"
TRAILERS

PERMA-LINER™
INDUSTRIES, INC.

1-866-336-2568 TOLL FREE

1-727-507-9749 INT'L

1-727-507-9849 FAX

RUSH



SALES



ALUMINUM TRANSPORT TRAILERS



350 CFM STEAM UNITS

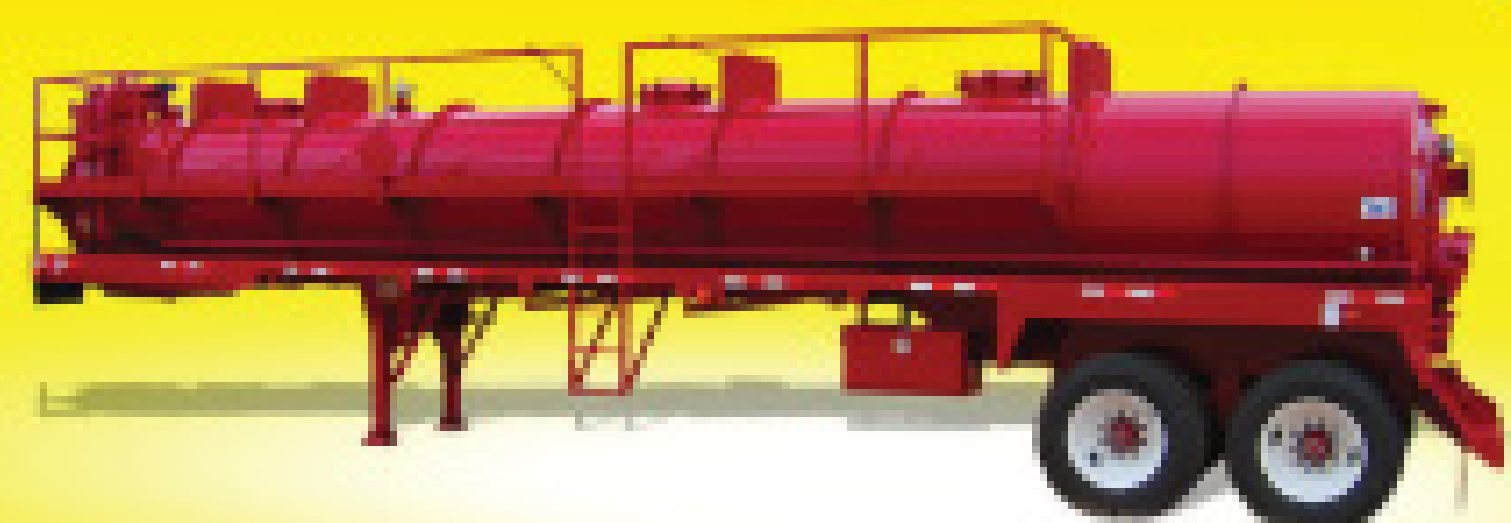

ASME CODE VACUUM TRAILERS

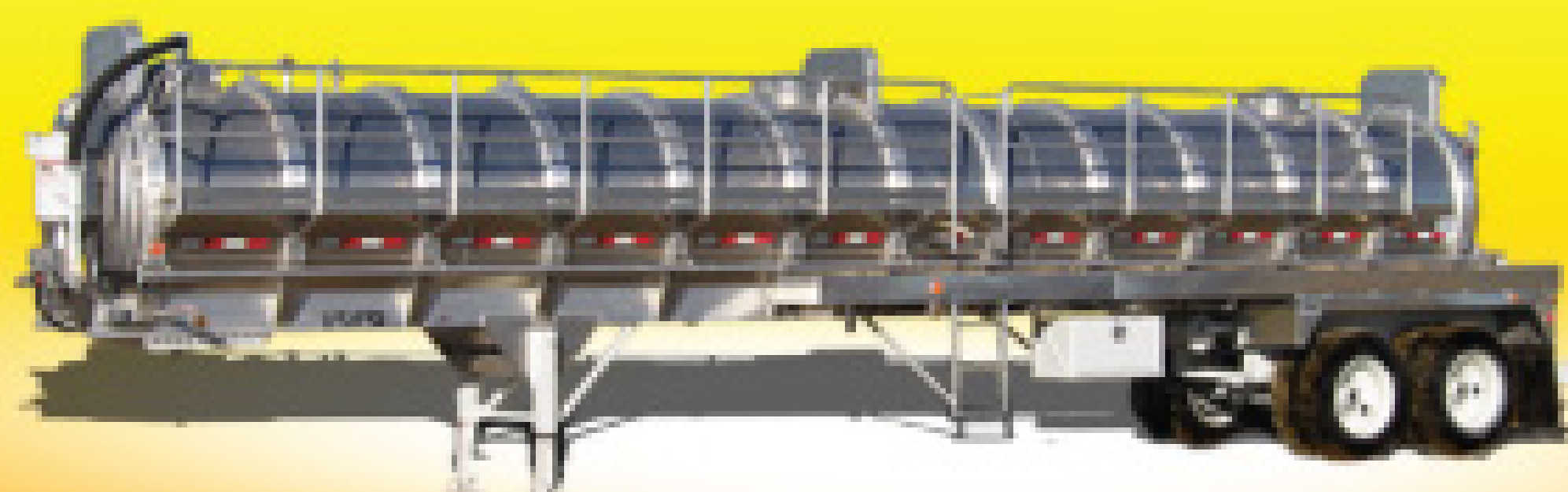

ALUMINUM VACUUM TRAILERS



INVERSION UNIT

2700 EAST I-20 ODESSA, TEXAS 79766 WWW.RUSHSALES.COM TOLL FREE: 800.489.2397

T&T TOOLS

T&T TOOLS, Inc.

FAX: 800.521.3260 | EMAIL: sales@TandTtools.com

800.521.6893

www.TandTtools.com

CALL FOR A FREE CATALOG!

CALL FOR A FREE CATALOG!

PROBES...

Insulated, standard, and specialty soil probes. Special 3/8" metal alloy shafts. Threaded and hardened tips.

HOOKS...

Specially designed Top Poppers make opening manhole covers a cinch. Try the Handy Hook for opening septic tank covers.

Don't Settle for Either/Or.

ROVVER Offers Video Inspection and Side-Scanning in a Single System, Which Means ROVVER Users Can Expand Their Capabilities As Business Requires.

If you're considering side-scanning to boost the efficiency and detail of pipeline inspection, demand a system that handles pipe of any material, condition and size (down to 6"). DigiSewer for ROVVER is the only side-scanner that adapts to real-world conditions while reaching speeds up to 70 fpm.

If you're looking for traditional video inspection, keep in mind that ROVVER—the industry's most agile, versatile crawler—lets you upgrade to side-scanning at a fraction the cost of competing systems.

Best of all, DigiSewer for ROVVER offers this versatility while remaining the leading innovator in side-scanning, offering features like virtual pan/tilt, inclination graphing, joint/tap auto-recognition, PACP color-coding, and full WinCan integration.

Adjustable camera height ensures centerline view and even illumination.



For special applications, rent larger or smaller ROVVER crawler bodies to work with your system.



Interchangeable wheels address a broad array of pipe sizes, materials and conditions.

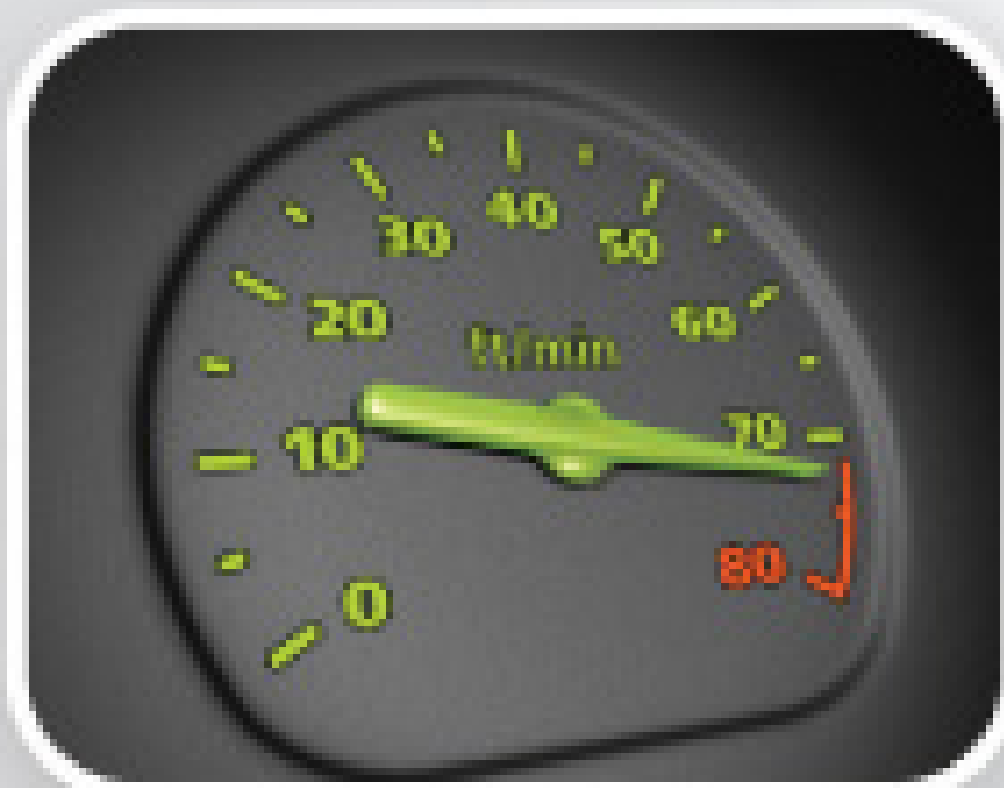

Side-scanning at speeds up to 70 fpm.



Virtual pan/tilt with no cable in view.



Side-scanning and video inspection in a single system.

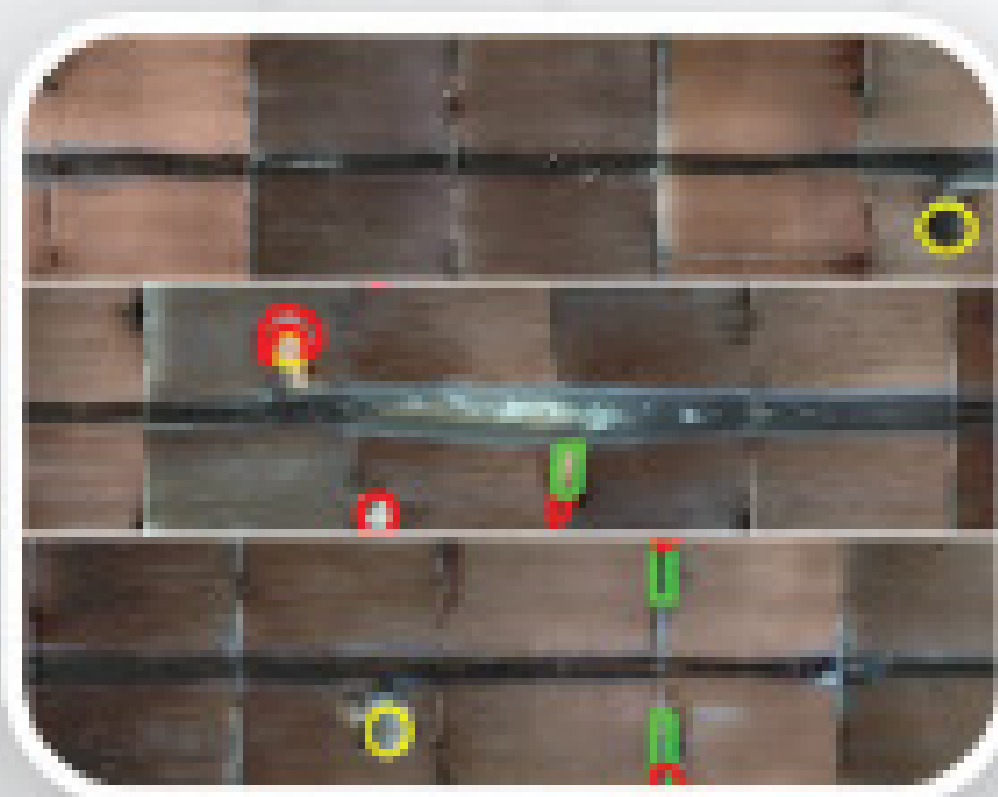

Quick analysis of entire section with PACP color-coding.



Comprehensive WinCan integration.

OWNER ADVANTAGE

- ▶ \$1000 EnviroSight Credit with DigiSewer Purchase*
- ▶ Camera Trade-In Options
- ▶ Discount Privileges
- ▶ Largest Network of Regional Service Centers Across North America

www.envirosight.com • (866) 936-8476 • fax (973) 252-1176
 Headquarters: Randolph, New Jersey • Sales & Service Offices Worldwide

Envirosight LLC
 SPECIALISTS IN PIPELINE INSPECTION



DIGISEWER

Side-Scanning for **ROVVER**™

*Credit can be applied toward future purchases. DigiSewer excluded. Offer valid until 1/1/10. DigiSewer, ROVVER, EnviroSight and their respective logos are trademarks of EnviroSight, LLC. ©2008 EnviroSight, LLC. All rights reserved. DigiSewer camera patent 7,164,476. WinCan is a trademark of CD-Lab.

Risky Business

Teaching employees to break the cycle of at-risk behavior begins with the business owner

By Gary A. Higbee EMBA CSP

When an employee is injured or experiences a near miss, perhaps you have asked yourself: Why did he do that? What was he thinking?

Or maybe you have wondered why you did something you wished you hadn't. We all take risks. Even as a safety professional, it wasn't until a

prevent potential injuries. The list isn't long. Only four errors are responsible for more than 90 percent of all the acute injuries people suffer. They are:

1. Eyes not on task; or moving hands, feet, or body without looking first.
2. Mind not on task.
3. Being in or moving into the line of fire.
4. Losing balance, traction or grip.

State of mind

None of us make these errors on purpose. Our state of mind greatly affects the efficiency and safety of our work. Errors occur when we are in one of four states:

Rushing. This doesn't mean just going fast. It means going faster than normal, which increases the risk of injury significantly. One

example is trying to finish in 10 minutes a job that takes 15 minutes under the best conditions.

Frustration. When things don't go well, emotions run high. The nut won't break loose, so you jerk on the wrench; it slips off, and you scrape your knuckles. Maybe some penetrating oil would have solved the problem, but once frustration sets in, clear thinking is ruled out.

Fatigue. Our society is suffering a sleep deprivation epidemic, but extended work hours, high exertion, boredom, and a host of other factors also can cause fatigue.

Complacency. We become numb to hazards.

Other states like depression, illness, and panic can take your mind and eyes off the task, but these four are most likely to cause trouble on a day-to-day basis.

the first three critical errors, but has limited effectiveness on complacency.

Analyze close calls and small injuries to prevent big ones. Learning to trigger on the state of mind takes time and practice, so while you're improving your safety skills, don't miss the opportunity to learn from mistakes. Analyze those errors and close calls to see what states were involved. If it wasn't a state, maybe a habit needs changing.

Observe others for state-to-error patterns. Here is where we find the most help with complacency. For example, when we see people driving erratically while trying to read a map or use a cell phone, we know something serious could happen. Avoiding them may be the best defense against injury. The driver is obviously very complacent.

Notice and intervene

It's always easier to spot the state-to-error pattern in co-workers, family, and friends. Noticing it creates a great opportunity to intervene before someone is injured, and it helps avoid complacency.

Changing habits and improving personal safety skills takes work. One thing business owners should stress to employees and do themselves is to look before moving and check the footing. Moving your eyes before you move your body (or car) is the best defense against injury.

Recognizing at-risk patterns helps you defuse those situations. As you practice, you will become more aware of these patterns in yourself. Try it, and see how the risk of injury at work or at home can be significantly reduced.

Gary Higbee founded Higbee & Associates Inc., a full-service safety training and consulting firm in Johnston, Iowa. He also is the Senior U.S. Safety Consultant for SafeStart and SafeTrack North America. For information on SafeStart, call 515/270-6623 or visit www.higbeeandassociates.com. ■

Acute injury pattern

Making one of the four basic errors increases the likelihood of injury, no matter where you are or what you are doing. It's fine to tell people to be careful, follow directions, and watch what they're doing, but that doesn't increase safety skills.

So what can business owners do about it? A few basic skill development techniques can help prevent injuries. While they are more effective when taught through a comprehensive course, you can learn a great deal about yourself and your personal safety skills by practicing these techniques, then teaching them to your team.

Self-trigger on the state of mind to prevent or avoid making the error. Many of us do this already. When frustrated, we stop and walk away from the task to regain our composure. But without practice, we may not trigger soon enough or at all. Learning to trigger when in a state of rushing, frustration, or fatigue can prevent us from making one of the four errors that get us hurt. Even when forced to rush, we can use that realization to increase alertness and focus extra hard on the task. This technique works well on

Safety FIRST

few years ago that I began to understand risk and why people take it.

Learning to recognize risk should be a part of every business owners' safety program. It allows you or co-workers to intervene and

UNIVERSAL ROLLER SKID

PROTECT YOUR INVESTMENT · STAY ABOVE THE WATER LINE · WORKS WITH MOST CAMERAS



NEW
TrapMaster
Negotiates a 4" Trap

URS1
• Patented Spring-Loaded Design Automatically Centers in 6-12" & Larger Pipelines, No Extra Parts Tools or Manual Adjustments Required.
• Provides Mounting for Auxiliary Lighting.

URS4
Ideal for 4-6" Lines

UNIVERSAL ROLLER SKIDS

- EASILY NEGOTIATES 90° BENDS.
- REDUCES WEAR & TEAR ON YOUR CAMERA HEAD.
- CONSTRUCTED OF SUPER TOUGH COMPOSITE NYLON.
- LIGHTWEIGHT AND DURABLE, WILL NOT CORRODE.
- DESIGNED FOR EASY MAINTENANCE.

TEST DRIVE THEM

RABCO www.Rootersupply.com
Tel: 203-230-1693 · 800-237-2467
Fax: 203-230-2956 · 800-535-3332

Healing Power

It's time to turn to Jetstream. Again

Jetstream, the name that made believers everywhere with the world's first waterblaster to provide a true 10k to 40k conversion ...

Jetstream, the name that gave you peace of mind with its simplicity and power ...

Jetstream is ready to heal your pain.

No more short accessory life due to dirty water. With the Jetstream X-Series, you have new reason for faith—a water tank system that's nothing short of miraculous. By filtering early, the Jetstream X-Series frees water of dirt and contaminants before it reaches the pump, increasing the life of your pump, hose and accessories.

No more trips to the shop to change pressure.

Jetstream X-Series units can be converted in the field from 10,000 or 20,000 psi to 40,000 psi.

And the healing power of Jetstream keeps the pain at bay—with ease of operation, ease of service, increased fuel efficiency and greater productivity.



Join us where the water flows pure. Come to Jetstream. Experience the healing power of the X-Series.

*For a demonstration, call **1-800/231-8192** or visit **www.waterblast.com**.*

Jetstream[®]
Subsidiary of Federal Signal Corporation

©2007 Federal Signal Corporation, listed on the NYSE by the symbol FSS.



QUALITY SERVICE VALUE

VALUE SERVICE QUALITY

PIRANHA

QUALITY SERVICE VALUE

VALUE SERVICE QUALITY



PIRANHA SEWER HOSE PRODUCTS

SP SEWER HOSE: 2,500 PSI
Orange Cover: 5/8", 3/4", 1", and 1 1/4"

HP SEWER HOSE: 3,000 PSI
Blue Cover: 3/4" and 1"

SHP SEWER HOSE: 4,000 PSI
Black Cover: 1/2" and 5/8"

LATERAL LINE: 4,000 PSI and 5,000 PSI
(Safety Green Cover) (Red Cover)
1/8", 3/16", 1/4" and 3/8"

HALF INCH SEWER HOSE:
3000 PSI, 4000 PSI and 5000 PSI

ASK US ABOUT
ARMOR BELT™
THE NEW STANDARD FOR SEWER HOSE
(available thru select distributors)

Call for a distributor near you

1-800-250-5132

Tel: 231-779-4390

Fax: 231-779-4399

sales@piranhahose.com

www.piranhahose.com

This Is The Nozzle You've Been Waiting For

Patented Root Rat®

MADE IN THE USA

root cutter nozzle



1/2" 7-35 gpm/1500-10,000 psi

3/4-1" 40-160 gpm/1500-4000 psi

"I specialize in root extraction and own 2 sizes of Root Rats and have found them to be superior in performance. I am happy to recommend the Root Rats to anyone who cleans drains."

Jeff, Jasco Inc



3/8" 3-10 gpm/2000-7500 psi

"The Root Rat is the easiest and most versatile root cutter nozzle I have ever used. The Root Rat works where other nozzles fail."

Tim Jones, owner of Eastern Sewer Jetting



Chempure's Hot Box

This Hot Box turns a cold water jetter into a hot water jetter to de-ice, to dissolve grease, etc. depending on the flow rate it can heat the water up to 185° F.

Custom Built Jetters

Hot or cold water jetters from 4gpm at 4000psi to 12gpm at 4000psi, skid or cart frames or small trailer systems.

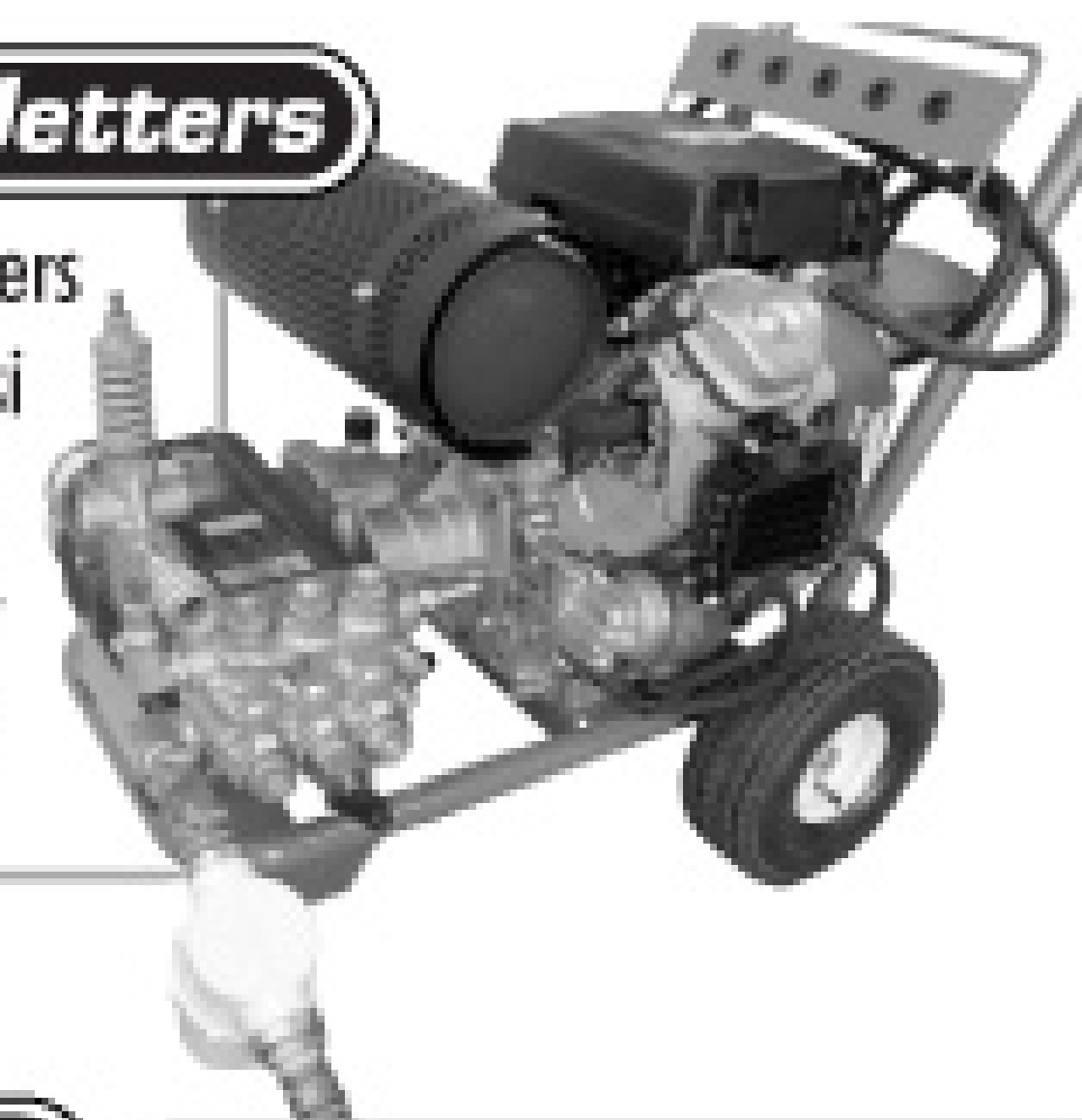

Root Rat Combo Kit

3/4 - 1 inch root rat combo kit. Use a reducer adapter to go from 1 inch to 3/4 inch.

"I bought the 3/8" Root Rat combo kit to use on my 4 gal at 3000 psi jetter, I cleaned out 100 ft of roots in a drain, WOW what a nozzle thanks to you and your company for a great product."

K.W., Mile High S&D Co

- WE SELL AND SERVICE COLD WATER JETTERS •
- WE SELL PARTS, PUMPS, UNLOADERS, HOSES, JET TIPS, ETC. •

CHEMPURE PRODUCTS INC.

1-800-288-7873 • 330.874.4300

www.chempure.com

Visa, Mastercard, Discover, Amx Accepted



Thank you for visiting us



WE DELIVER MORE THAN JUST A SHINY NEW TRUCK...

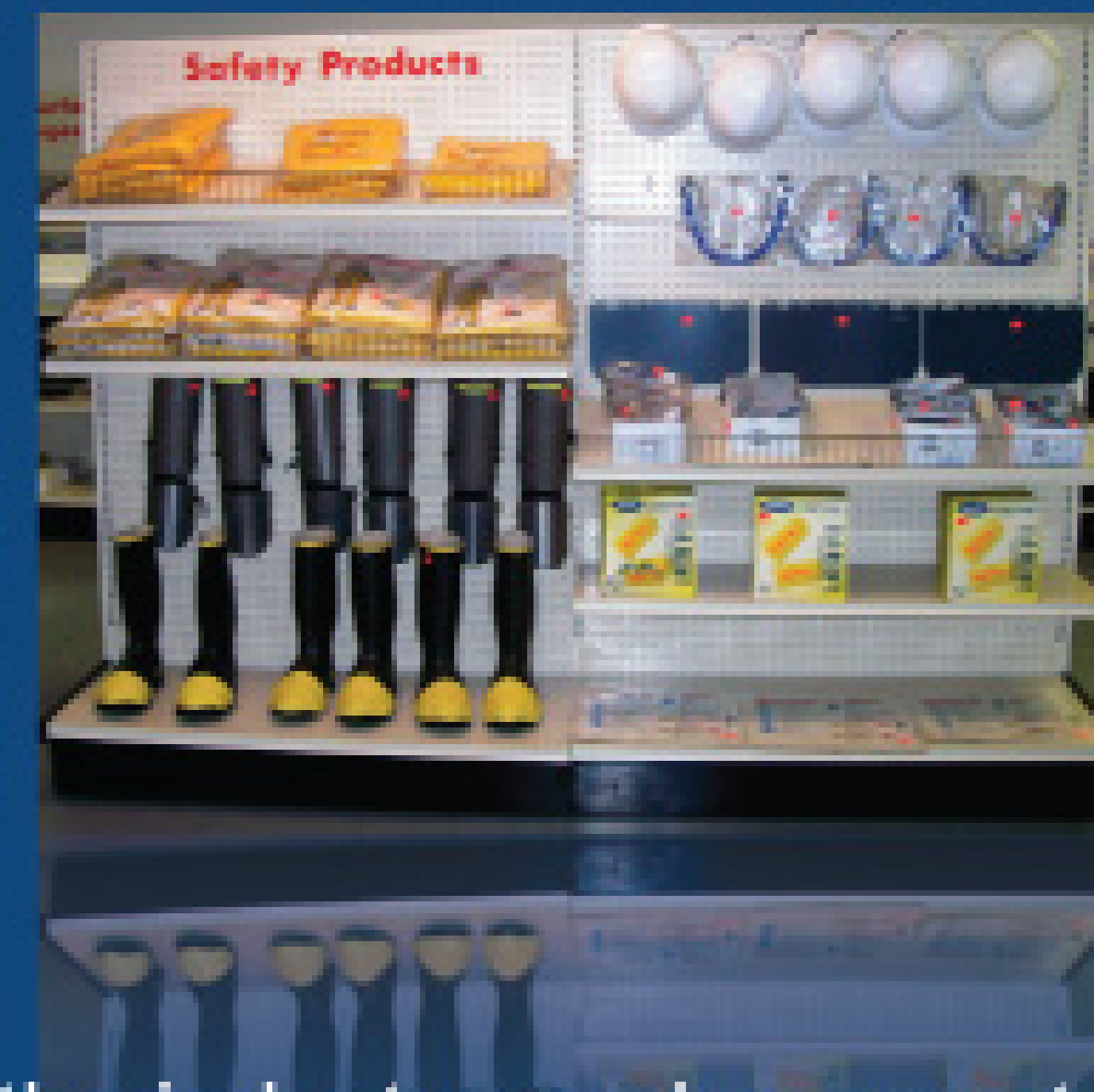
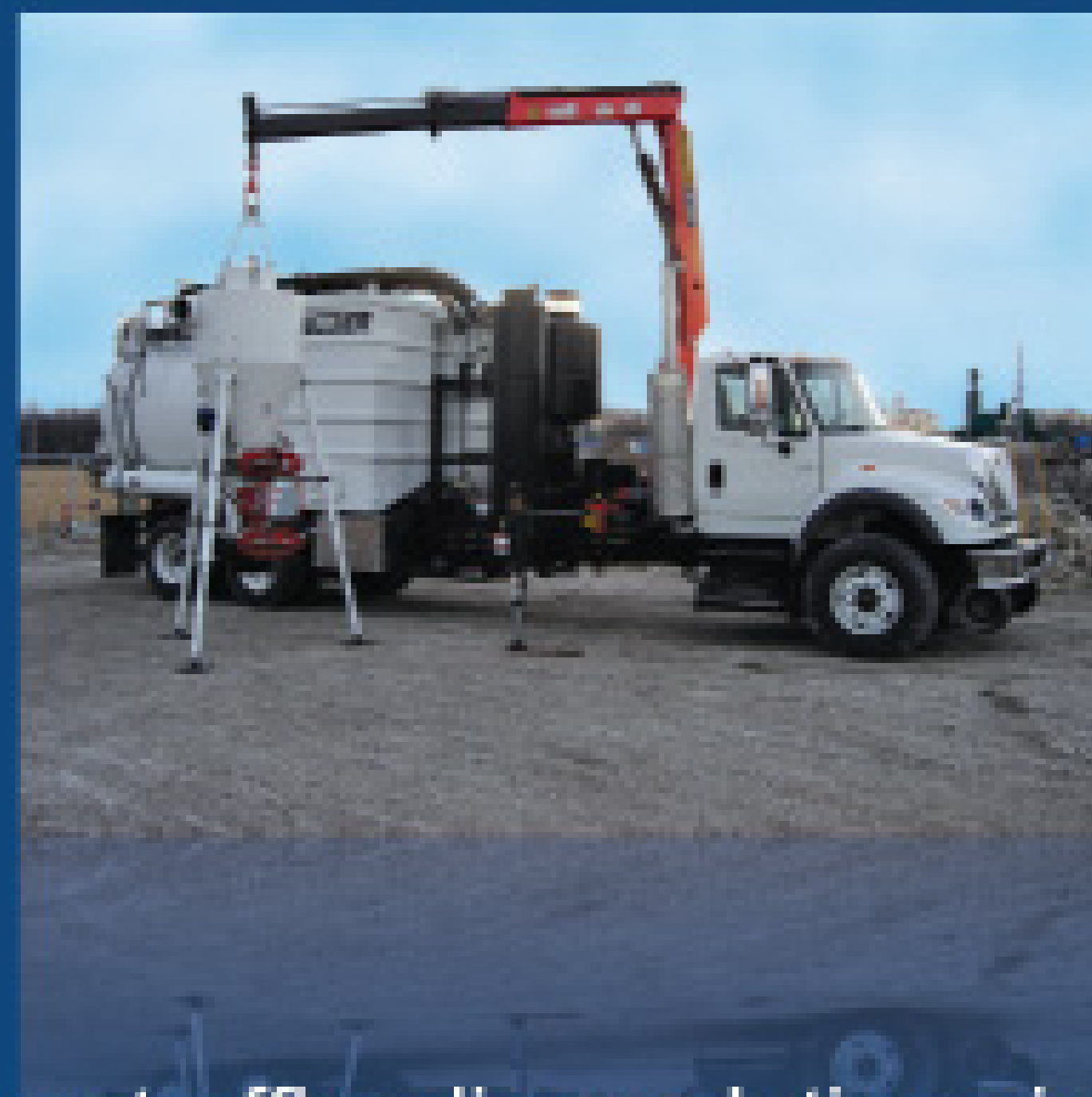
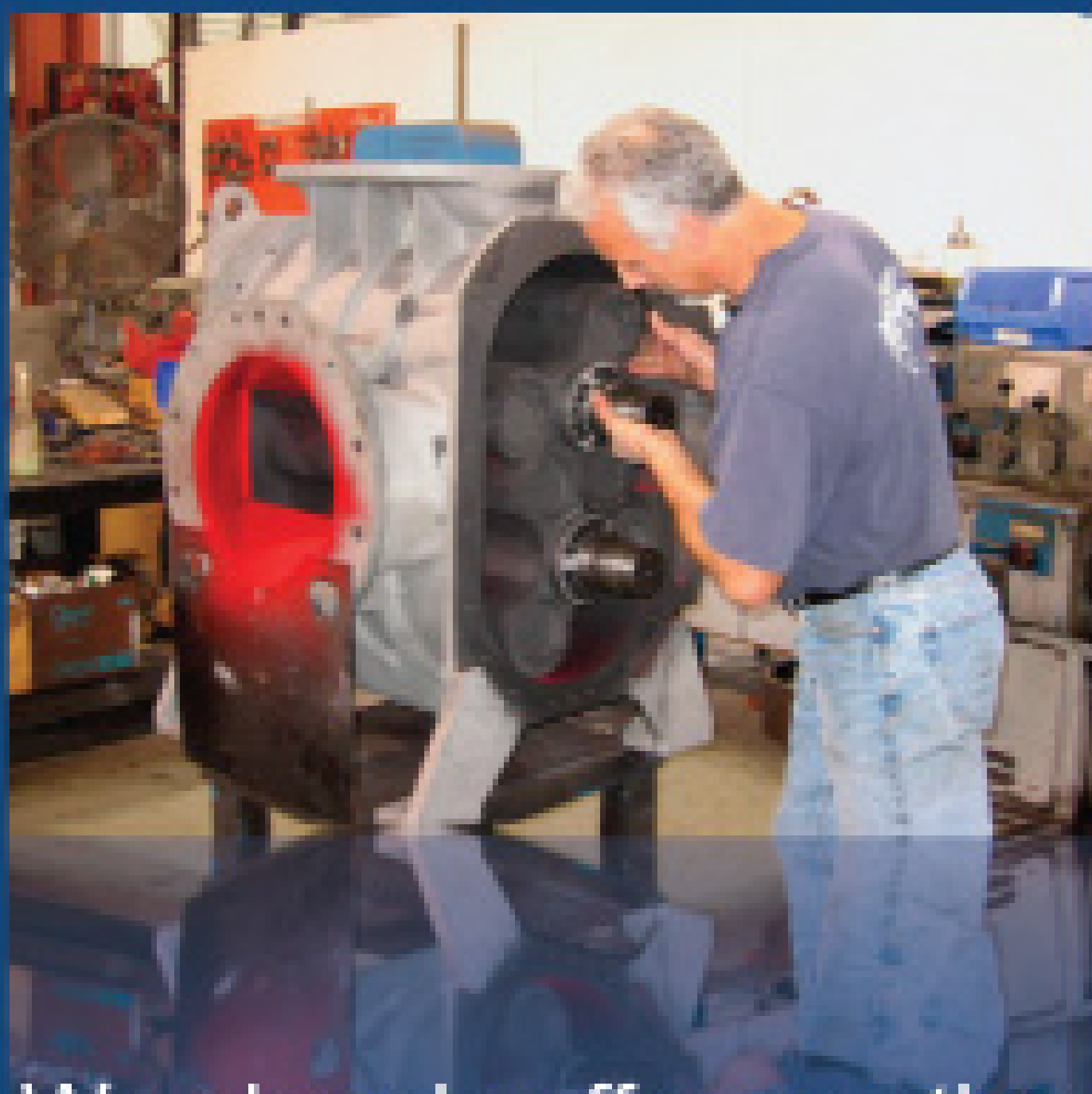

We already offer you the most offloading solutions in the industry, and can custom build our vacuum loaders to suit your exact needs. We can help you find financing. And, with our Right Start program, we personally deliver the keys, provide operator and safety training and give you all the information you need to be more productive from the very beginning.

Beyond that we support your new or hard-used old trucks with fast access to genuine Guzzler parts and a toll-free number you can call for application expertise. We also have regional FS Solution service centers that can provide anything from minor repairs and refurbishing to total rebuilds.

And because we want your business to shine as much as a new truck we will pass along customer referrals every chance we get.

For a demo of a shiny new truck*, go to www.guzzler.com today, or call 1-800-627-3171

*Some qualifications apply.

©2008 Federal Signal Corporation. Listed on the NYSE by the symbol FSS.

GUZZLER
Subsidiary of Federal Signal Corporation

VSI

VACUUM SALES, INC.

51 STONE RD. • LINDENWOLD, NJ 08021

Low Interest Rate Financing Available!



Stock # 13234 Pipehunter Truck mounted jetting unit, 3,000 psi at 50 gpm with a 1,000 U.S. gallons water tank, rear mounted hose reel with a Jet Eye Camera system mounted on a 2006 GMC TC6500 cab & chassis. Less than 6,000 miles. **Special Pumper & Cleaner Environmental Expo Pricing \$179,000**



Stock # 4648V 2003 Sterling Model LT9513 Cab & Chassis with a Vac-Con Model VPD4216LHA/1300 combination vacuum loader & high pressure sewer cleaning system. Less than 95,000 miles. **Special Pumper & Cleaner Environmental Expo \$169,000**

888.VAC.UNIT
(888.822.8648)

www.VacuumSalesInc.com

Sales, Parts & Service

Wolf Creek Co.

Original Bauer

Portable Piping

Bauer Fittings

Polybarb™ Pipe & Tails

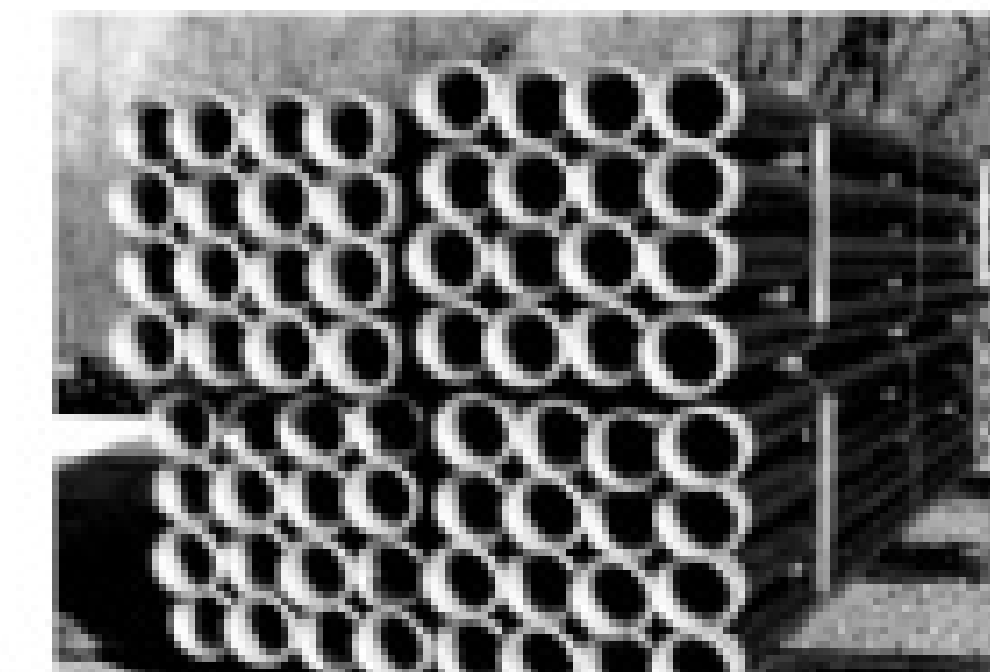

Polybarb™ HDPE pipes and fusible tails available in 4" to 12" diameters up to 40' in length.

Available in weldable, hose insert, and flanged connections. Fittings available from 2" to 12".

Industrial Vac Tubes

We can fabricate aluminum vacuum evacuation or suction tubes per your specifications. Using the Bauer Coupler or Anfor Coupler.



Bauer Pipe

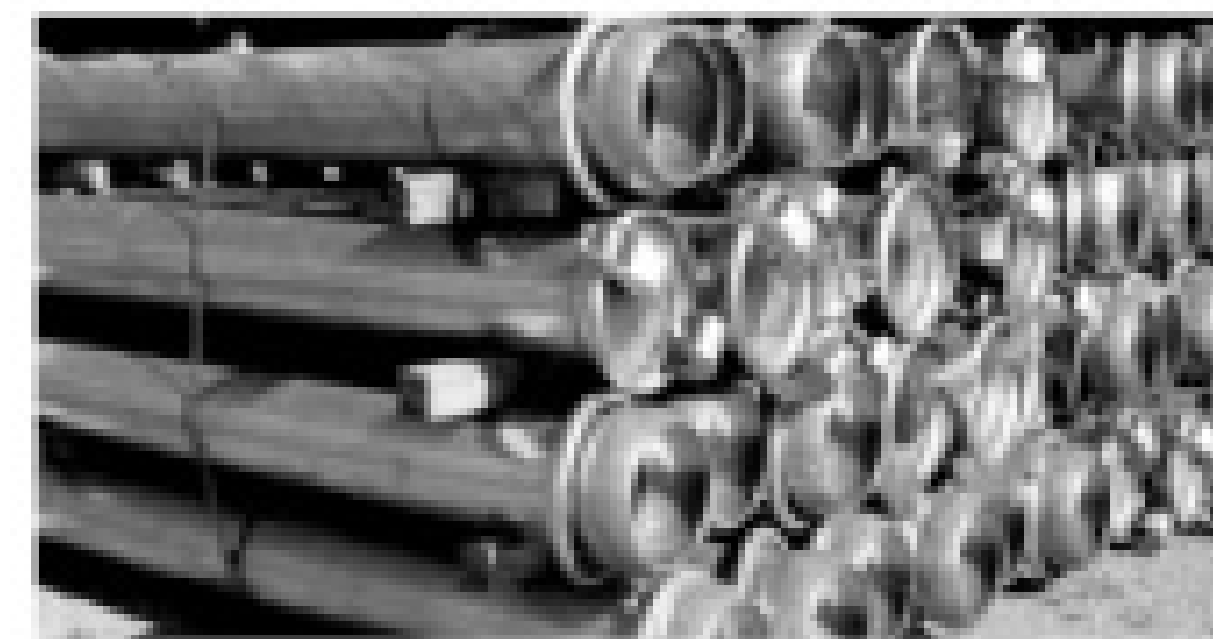

Galvanized piping available in 2" to 12"

800.488.7305 • www.wolfcreekcompany.com

NEW INSURANCE PROGRAM FOR SEWER & DRAIN LINE CLEANERS

AVAILABLE IN 28 STATES



HEFFERNAN INSURANCE BROKERS

11TH LARGEST INDEPENDENTLY OWNED PROPERTY & CASUALTY BROKER IN US

Providing liability, property, auto, and umbrella coverages for:

- ❖ Line Cleaning
- ❖ Industrial Cleaning
- ❖ Hydro-Excavating
- ❖ Portable Restrooms
- ❖ Grease Trap Cleaning
- ❖ Septic System Install

Mark Herring,
CRM, CIC, LUTCF
Vice President

Phone 800-208-6912
Fax 800-215-0147

...For the Last 10 Years!

The Emerson logo is a trademark and service mark of Emerson Electric Co. © 2008, RIDGID, Inc.



GOES ANYWHERE YOU GO.

The RIDGID® K-400 — The Most Portable Drain Cleaner Of Its Kind.

This new, heavy-duty drain cleaner for 1-1/2" to 4" lines is designed specifically for easy maneuverability to, from and on the job site. Its innovative features include a wheeled cart for portability; built-in, telescoping handle for easier transport and storage; and an integrated stair climber design for use in multi-story buildings. Get the K-400 and get going...anywhere you want.

Learn more and schedule demonstrations: 800.769.7743 or www.RIDGID.com.

We Build Reputations™

RIDGID®

EMERSON.
Professional Tools

DIAGNOSTICS

PRESSING

PIPE & TUBE TOOLS

DRAIN MAINTENANCE

POWER TOOLS

Mastering Cash Flow

A key to success in business is managing what comes in and what goes out. These tips can help you keep monthly income ahead of operating expenses.

By Ty Freyvogel

Your success as a business owner comes down to whether you can pay your bills and still turn a profit. That may seem obvious — and yet achieving a healthy balance between monetary intake and output is an art that confounds many entrepreneurs.

It is no exaggeration to say that your ability to manage cash flow can make or break a business. Otherwise-successful business owners have crumbled under the stress of poorly managed cash flow. Likewise, owners have flourished under a well-structured, well-maintained accounting system.

Fortunately, it's not necessarily difficult to stay on top of the money coming into and going out of your company. Here are some practical insights:

Assume that your estimates are wrong — and save for a rainy day. No matter how carefully you plan for all potential cash-related scenarios, you can never accurately predict the weather of your operating environment. At any moment, a storm front or even an unexpected sunny day could appear out of nowhere.

It's a good idea to make rough estimates for your cash flow. Just be sure to give yourself a healthy margin for error and expect the unexpected. Keep a nice cushion of money in your account for surprise bills. Yes, entrepreneurship is based on taking risks, but where cash flow is concerned, err on the side of conservatism. Remember: Cash is king. Cash flow determines what you are able to do with your business.

Don't underestimate the value of a good customer. You have the choice to run your business as you see fit, but no matter how successful and powerful you become, remember that your customers are the reason you exist. The loss of a steady customer means loss of reliable income that can be very difficult to replace.

So be good to customers. One company may spend thousands or tens of thousands of dollars on your services over the years. If you're a consumer company, even one homeowner person can be worth thousands of dollars over the span of your business relationship. Never let success change your mission of giving all customers the royal treatment. They are the source of cash that you need to pay rent, taxes and other expenses, and provide a healthy profit.

Keep tabs on your expenses. Don't rely on your memory to know when to pay your bills, order new supplies or bill your clients. Even if you

run a very small business, you won't be able to pay everything on time if you don't have a system in place to help you keep track.

Choose some reliable method to help you track your bills and their due dates. Your system can be as simple as a notebook where you document when to write checks and when to deposit funds that come in. Far better, use computerized accounting software. Being well organized will ensure that your supplies are always in stock, your power never goes out, your employees get paid, and you make money.

Be firm but kind with clients. It is important to run your business in a manner that tolerates a certain amount of leniency — but don't let customers walk all over you. If you establish yourself as a pushover, even clients with the best intentions will take advantage of you.

On the other hand, you don't need to run your company with an iron fist. Find a happy medium that keeps you in business and keeps

Don't be afraid to politely call a customer who hasn't paid a bill and remind him or her that it is overdue. They understand that you have provided a service and that it requires a payment. You can preserve your client relationship and get your money by treating customers with integrity.

your clients happy. Don't be afraid to politely call a customer who hasn't paid a bill and remind him or her that it is overdue. They understand that you have provided a service and that it requires a payment. You can preserve your client relationship *and* get your money by treating customers with integrity.

At the bare minimum, break even. You have to at least break even each month in order to survive. In hard times, strive to break even — and then get back on track. Engrave your break-even number in your mind or sticky-note it to the front of your computer, and see that you surpass that number each month — by a healthy margin in all but the toughest times.

Here's a quick tip: If you are having problems breaking even, and if that means you may be late

in paying vendors, let them know. Don't keep them in the dark. No one likes surprises, especially your bank.

Be honest with the man. Never try to improve cash flow by cheating the taxman. Some (supposedly) clever people have filtered out money from their business and kept it out of the government's grasp — but usually only for a while.

You may get away with hiding money, under-reporting income, or fudging your write-offs, but the odds are against you. Uncle Sam has gone to great lengths to set up systems that keep this from happening easily. In general, the rewards of cheating do not justify the risks.

Why taxes are good — really! Many businesses try to show a very small profit at year's end so they can cut their tax liability. But if you keep your business account so low that you don't have enough cushion to pay an unexpected bill, cash flow is damaged.

Instead of taking tax avoidance to extremes, get out there and try to make more money. If you think about taxes in the right way, you won't view them as such a bad thing. In the end, paying more taxes is a sign that you are doing very well.

Keep away from credit cards if possible. Credit cards are necessary, but that doesn't mean that you should run up a mountain of debt. Businesses shut down because of factors like credit card debt, so swipe with caution if you have to swipe at all. Don't max them out, by any means. If you find that you have to max out a credit card, your business may already be in trouble and it is time to seek alternate funding.

Don't worry if managing your cash flow seems difficult and even overwhelming at first. After a few months, you will embrace your monthly monetary obligations. You may even find a sense of comfort in the ebb and flow of money. Like the tides and the seasons, cash flow has a natural rhythm that keeps you grounded and helps you make sense of your place in the business world.

Before you know it, you will use cash flow as a gauge of your ability to take risks. That knowledge will help you make the kinds of smart decisions that help your company grow and flourish. ■

Ty Freyvogel owns the consulting firm Freyvogel Communications and is author of *It's Not Your Smarts, It's Your Schmooze* and *Seize the Century!* He can be reached through his web site, www.EntrepreneursLab.com.



"Simplify your life!"

SCOOTERS ARE EASY TO USE,
TOUGH AND DEPENDABLE.
DON'T LEAVE THE SHOP WITHOUT ONE.



Prototek
Line Locating Tools - We
Feature the Finest!



COLOR
Video Inspection Systems
Complete from **\$4,595**

Black & White
Video Inspection Systems
Complete from **\$3,295**

FEATURES:

- Diffuser lighting
- Flexrite gooseneck
- Quick change cameras
- Ultra tough pushrod
- Lightweight/compact
- Solid state lights
- One Year warranty

OPTIONS:

- Image inverters
- Voice over
- VCR/monitors
- Locators
- Carrying cases

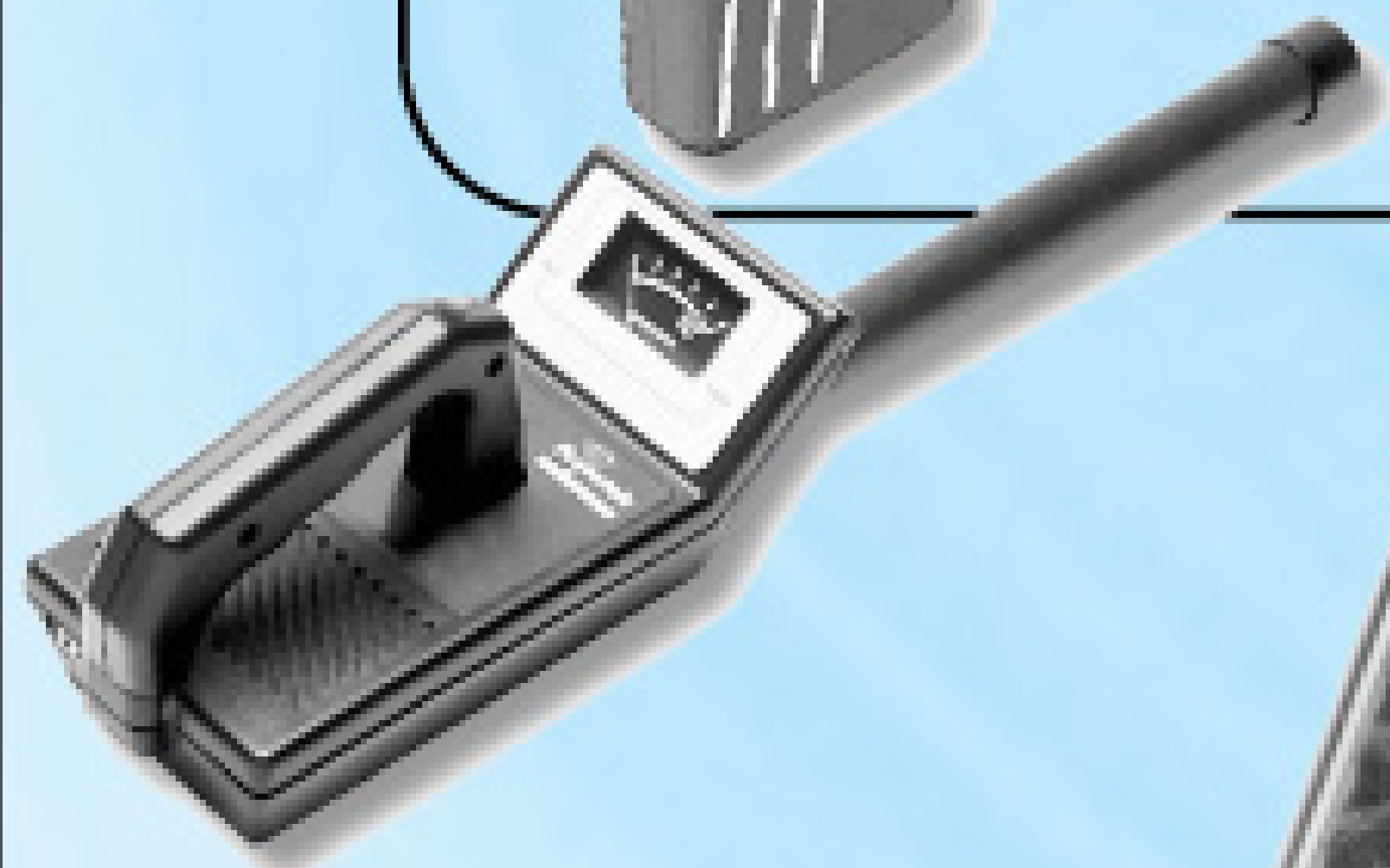

**Now
with
DVD!**

The New Attaché Monitor
Lightweight & Compact!

VCR combo can be ordered with any Scooter system!

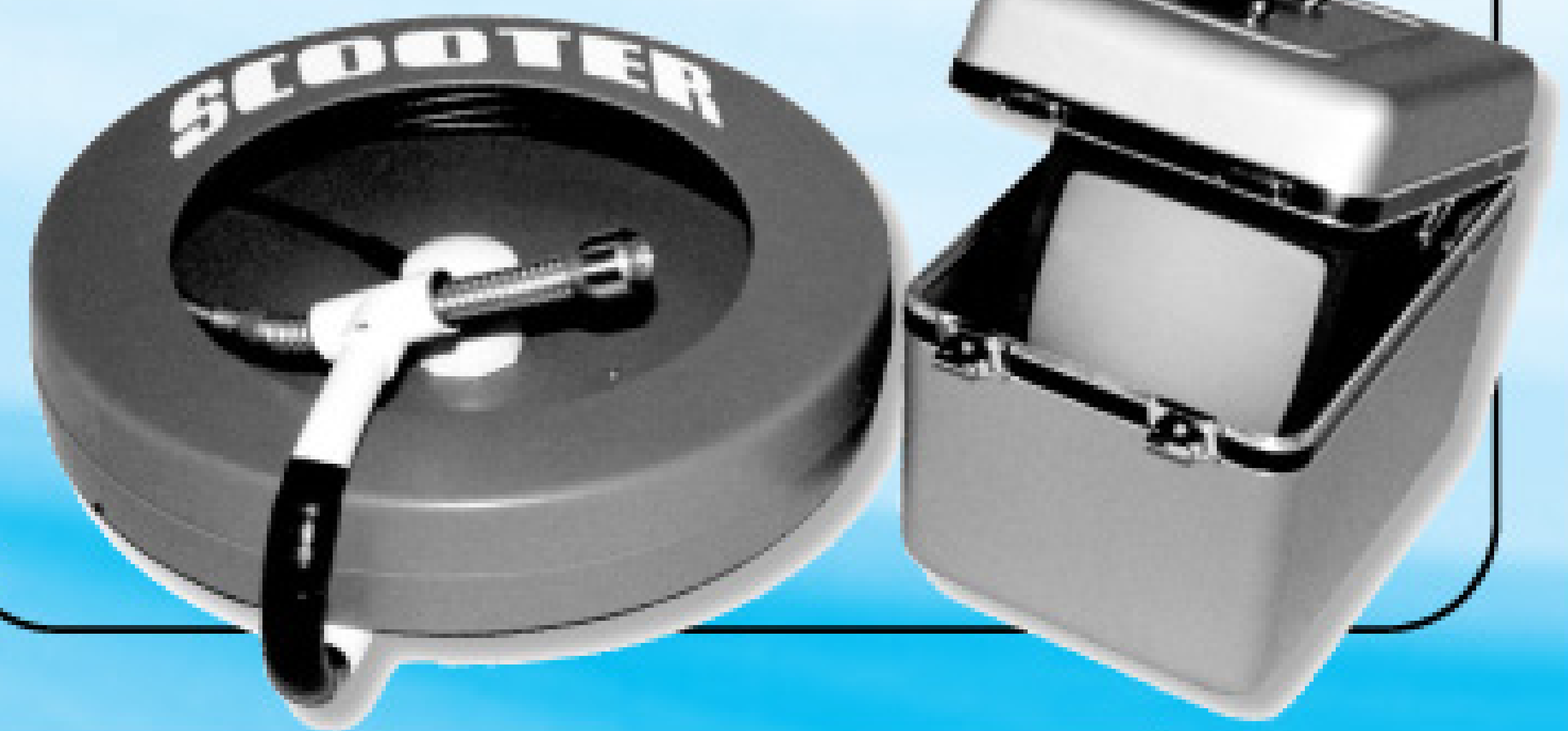

SCOOTER

VIDEO
INSPECTION SYSTEMS

20843 Santa Lucia • Tehachapi, CA 93561 • Fax: 661.822.8917

TM



800.772.6165 www.tvinspection.com

Why rely on StoneAge® equipment?

Superior Tools and Outstanding Service



Precision Engineering

We provide our customers with high quality, innovative tools. Our manufacturing facility features state-of-the-art machining and production equipment, resulting in the finest waterblast tools available today.

Quality Control

Every swivel, every nozzle, and every assembly is carefully inspected to ensure our customers receive the highest quality jets and rotating assemblies. Our customers believe the results are worth the extra effort.

Assembly and Testing

We know how important it is to have tools that work right out of the box. For that reason all **StoneAge**® tools are tested at operating pressures before shipping, guaranteeing both performance and customer satisfaction.

Over \$3 Million in Inventory

Reducing down-time is critical. That's why we stock over \$3 million in tools and parts, so our customers can receive new assemblies and replacement parts right away. Eighty percent of our orders are expedited for next day delivery.

Live Technical Specialists

We promise to have a live person handling your inquiry. Our customer service specialists have decades of waterblast experience and are here to help. The result matches the right tool options with your expensive pump, enhancing productivity.

 **STONEAGE**
WATERBLAST TOOLS

Toll Free: 1.866.795.1586 • Phone: 970.259.2869 • Fax: 1.970.259.2868 • 466 S. Skyline Dr. • Durango CO 81303 • www.stoneagetools.com • www.sewernozzles.com

PRO  **WAG**
INDUSTRIAL PUMPOUT STATION

There is no substitute for professional pumping equipment

- Ideal for grease trap pumping
- Extremely maneuverable, can go just about anywhere
- Pumps fast, 60 GPM, 60 gal. capacity
- Will not blow 15 amp breakers
- Will not overflow
- Has odor control technology
- Comes complete with everything needed for pumping
- Factory direct with factory support

Call today for complete information and specifications on the industries' most complete portable pumpout unit.



Toll Free
Westmoor Ltd.

800-367-0972

P.O. Box 99
Sherrill, New York 13461

NOW 30% More Power!



On The Web At: www.westmoorltd.com, e-mail: pumps@westmoorltd.com

"Warthogs Work for Me"

CALL FOR NEW CATALOG!



Dave Runyan
Brunswick, GA

"The Only Nozzles I Use Now!"

"After meeting the **StoneAge** crew at the Pumper and Cleaner Show in Nashville I decided to try one of the **WARTHOG** nozzles. My first purchase was a **WH-1/2** and it was a big investment for only one nozzle. However, the first time I used it I found it not only unstopped the line, after several passes it cleaned the line wall to wall.

Over the years I have added 2 more **WS-1/2**'s and a **WT-3/8** as well. **WARTHOG** nozzles are the only one's I recommend now for efficient root, grease and loose scale removal. Our policy is not just to unstop drains and sewers, but to clean them as well."

Dave Runyan

The **WARTHOG**® - 5 Models • 2k - 8k psi

- Handles Everything from 3" Lines to 36" Culverts
- Optional Accessories - Descaling Heads & Super Centralizers
- Durable Construction • Simple Maintenance • Superior Results

Distributors Worldwide
Visit sewernozzles.com
For the One Nearest You



WS-1/2

US Patent
5,964,414



466 S. Skylane Dr. • Durango, CO 81303 • www.sewernozzles.com • 1.866.795.1586

SEWER NOZZLES

NEW Website! NEW Machines! NEW ProClean Labels!

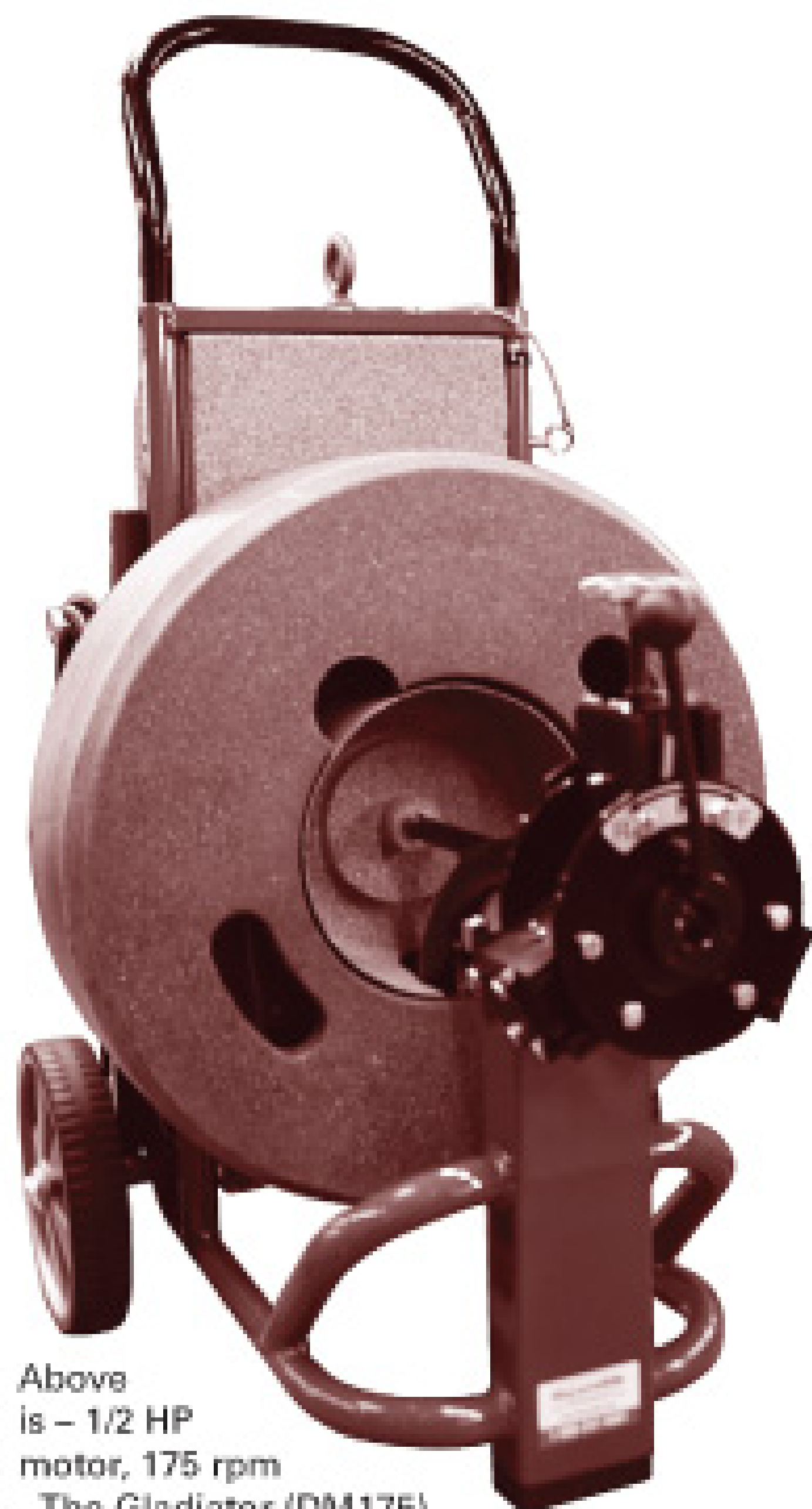

Above is - 1/2 HP motor, 175 rpm - The Gladiator (DM175) upright machine!



Above is - 1/4 HP motor, 230 rpm - The Esquire (DM138) machine!

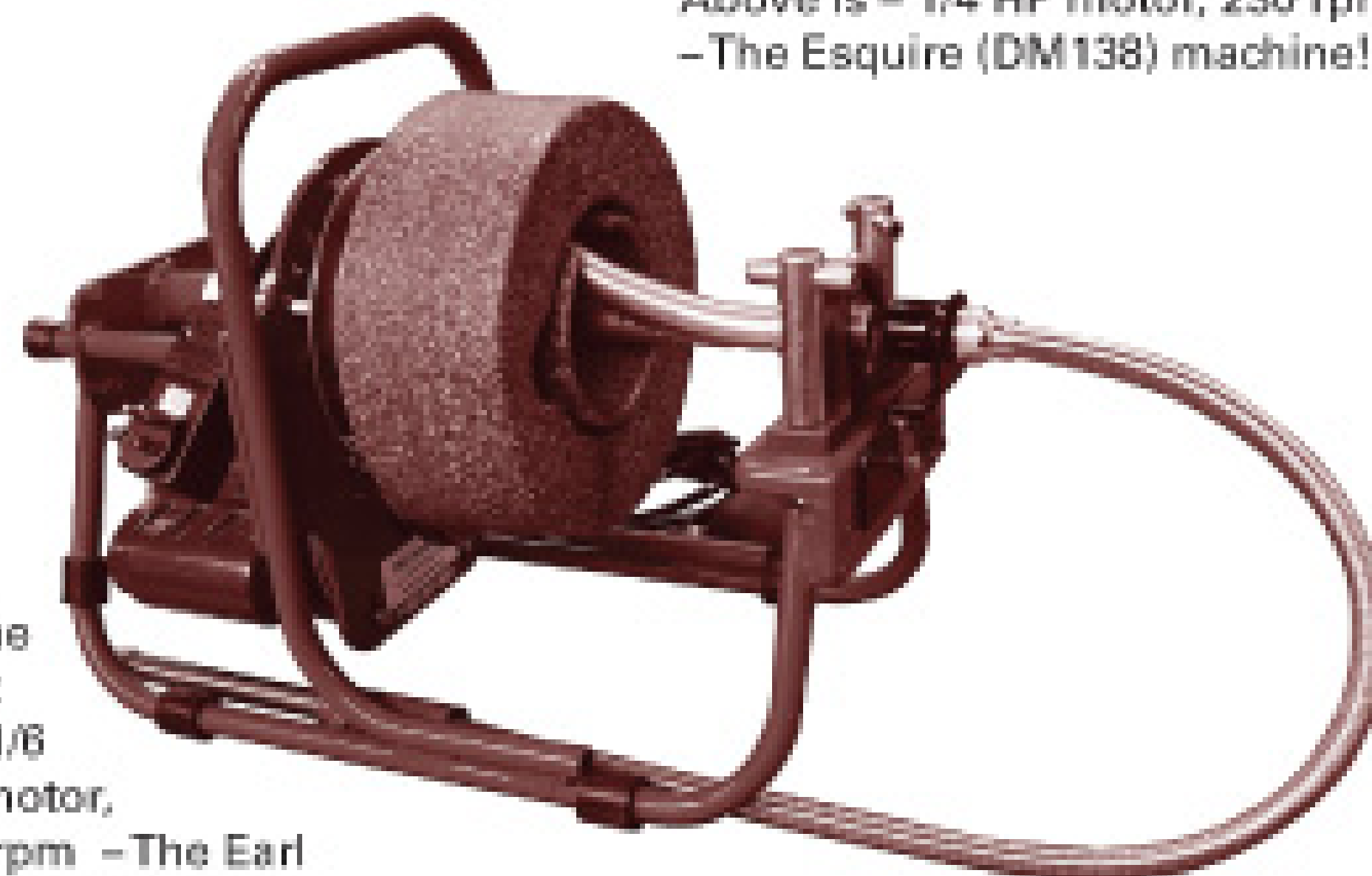

To the right is - 1/8 HP motor, 230 rpm - The Earl (DM125) machine!

Duracable®

Manufacturing Company

877-244-0556

www.duracable.com

sales@duracable.com



Duracable® Machines

Ends

ProClean® Drain Care

Blades

DuraFlex® Cable

PROTOTEK TOOLS ARE A BLUEPRINT FOR SUCCESS.



Whether you're 'down home' or 'downtown' a locating job is enough of a challenge without the added hazard of disturbing other utilities while you're servicing a sewer line. No need to call in extra help—Prototek's LineFinder 2100 is the tool for all purposes.

Prototek's LineFinder 2100

- AS A SONDE LOCATING TOOL, locate a 512 Hz sonde or camera with speed and precision. It also works with 16 Hz sondes for locating in steel or ductile iron lines. See our orange LMJ-6 below.

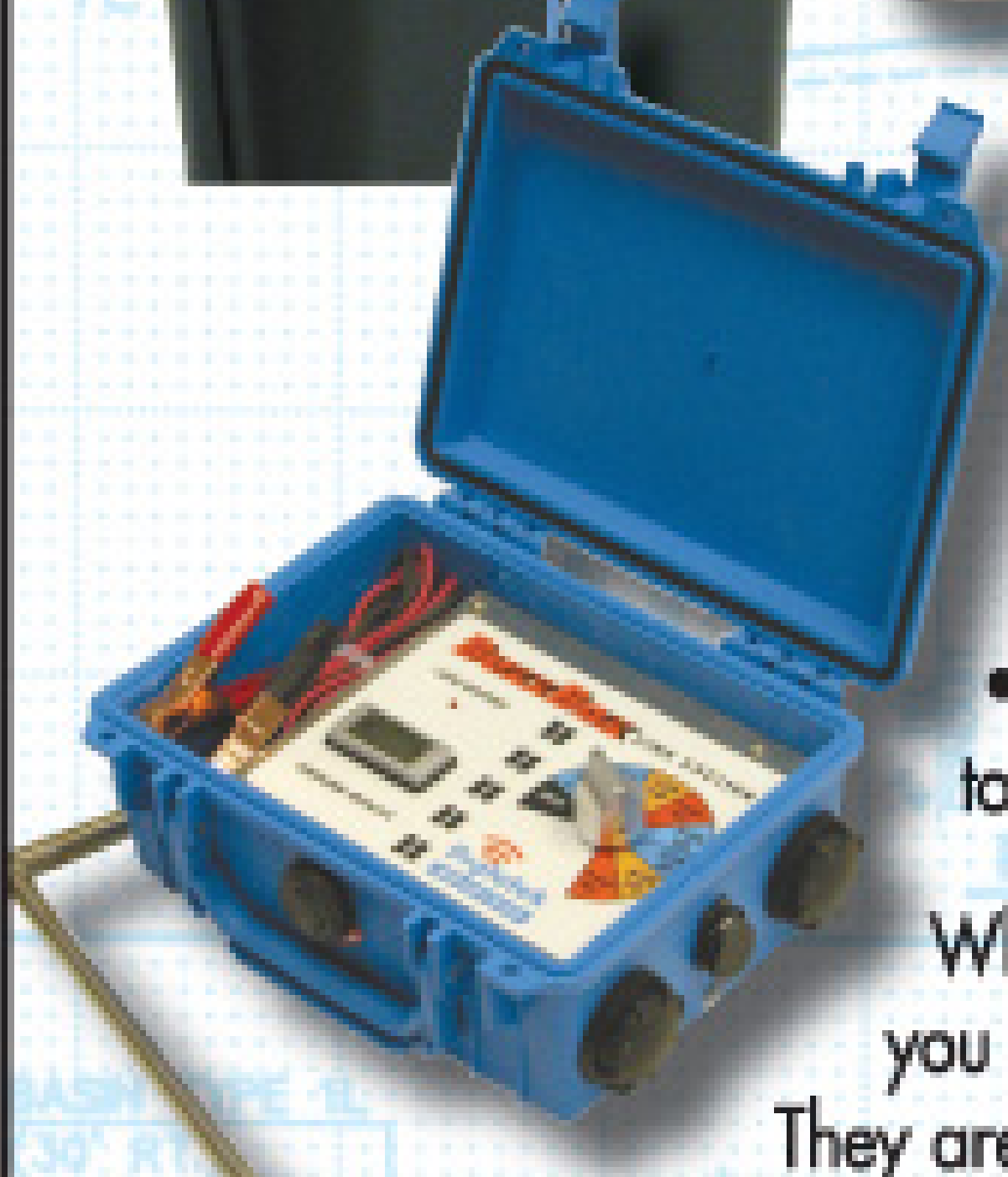

- AS AN ACTIVE LINE TRACING TOOL, detect and map underground utilities so you know where *not* to dig by teaming it with the Blue BuzzBox for conductive or inductive tracing at 4 standard frequencies.
- USE AS A PASSIVE LINE TRACING TOOL to trace energized 60 Hz power lines.

Whether it's pipe locating or line tracing you need, you can depend on Prototek tools. They are well designed, made to last, and easy to learn. You can depend on Prototek service, too. Call us today and let us show you how easy success can be.



Prototek

BREAKING NEW GROUND UNDERGROUND

800-541-9123



www.prototek.net Email: prototeksales@prototek.net



ARTHUR PRODUCTS CO.

an LSQ Mfg Company



"BUY DIRECT FROM THE MANUFACTURER"

Call 1.800.322.0510

Fax: 1.330.722.2698

E-Mail: jmsales@apclsq.com



Thank you for visiting us

www.arthurproducts.com

"All nozzles CUSTOM drilled"

CT 2000™

CITRUS GREASE EMULSIFIER/DRAIN MAINTAINER

NO OTHER PRODUCT WORKS FASTER OR HARDER ON GREASE.

WE GUARANTEE IT!

CT 2000 is:

- Environmentally safe
- Safe on all pipes
- Non acid, non caustic
- Non toxic
- Leaves drains citrus fresh
- Super concentrated – 1 gallon makes 5 gallons



Thank you for visiting us

TREAT YOURSELF TO BIG PROFITS!
TREAT DRAINS WITH CT 2000!

Mention This Ad and Receive 10% Off Your First Order!
Free Brochures With All Orders.



1815 E. Wilshire Ave. | Santa Ana, CA 92705

tel: 866-803-3466

fax: 714-835-3570

www.ct-2000.com



THE CABLE CENTER • 1-800-257-7209



**24 HOUR TURNAROUND - MIDWEST'S LARGEST FACTORY AUTHORIZED
REPAIR CENTER FOR GATORCAM, GEN-EYE & SEESNAKE**



Gen-Eye GL™

Basic Unit Machine Only

- Self-Leveling color camera keeps the water at the bottom of the screen.
- DVD Recorder provides a crisp picture with jitter-free freeze frame.
- Gel-Rod® protects against moisture damage if rod is cut or abraded.
- Built-in full keyboard titler with eight pages of text easily shows your company name and job location.

FREE DELIVERY

General J-2512 Typhoon™ Trailer Jet

Big cleaning power in a tough new package.



Blow away blockages in big lines and long runs. The Typhoon delivers 12 gpm at 2500 psi to blast lines clean of grease, sediment and debris.

- A 200-gallon holding tank carries enough water to handle remote applications where access to water is limited.
- 400 ft. capacity jet hose reel and 150 ft. capacity supply hose reel.
- Electric brakes, safety strobe light, rear fold-down stabilizer jacks, retractable hose guide arm, and antifreeze system

CALL FOR PRICING!

FREE DELIVERY

Compatible with Electric Eel® Connectors

1 1/4" x 8' - \$51.00
1 1/4" x 10' - \$56.00

BUY 3 GET 1 FREE!

Compatible with Ridgid® Cables

5/8" x 7.5' - \$21.00
7/8" x 15' - \$43.75
1 1/4" x 15' - \$68.25



Close Out Sale

Limited Quantities

Gen-Eye Junior™ Micro

- 100' of Micro-pushrod for 1-1/2" to 4" lines.
- AC/DC power supply.
- Picture Inverter.
- Built-in text writer.
- Light dimmer control
- Built-in on-screen distance counter - in feet or meters

- Built-in dual frequency transmitter (512 hz & 87 hz) that reduces interference.

\$2300

FREE DELIVERY



Mini-Rooter XP™

Basic Unit Machine Only

\$485

FREE DELIVERY

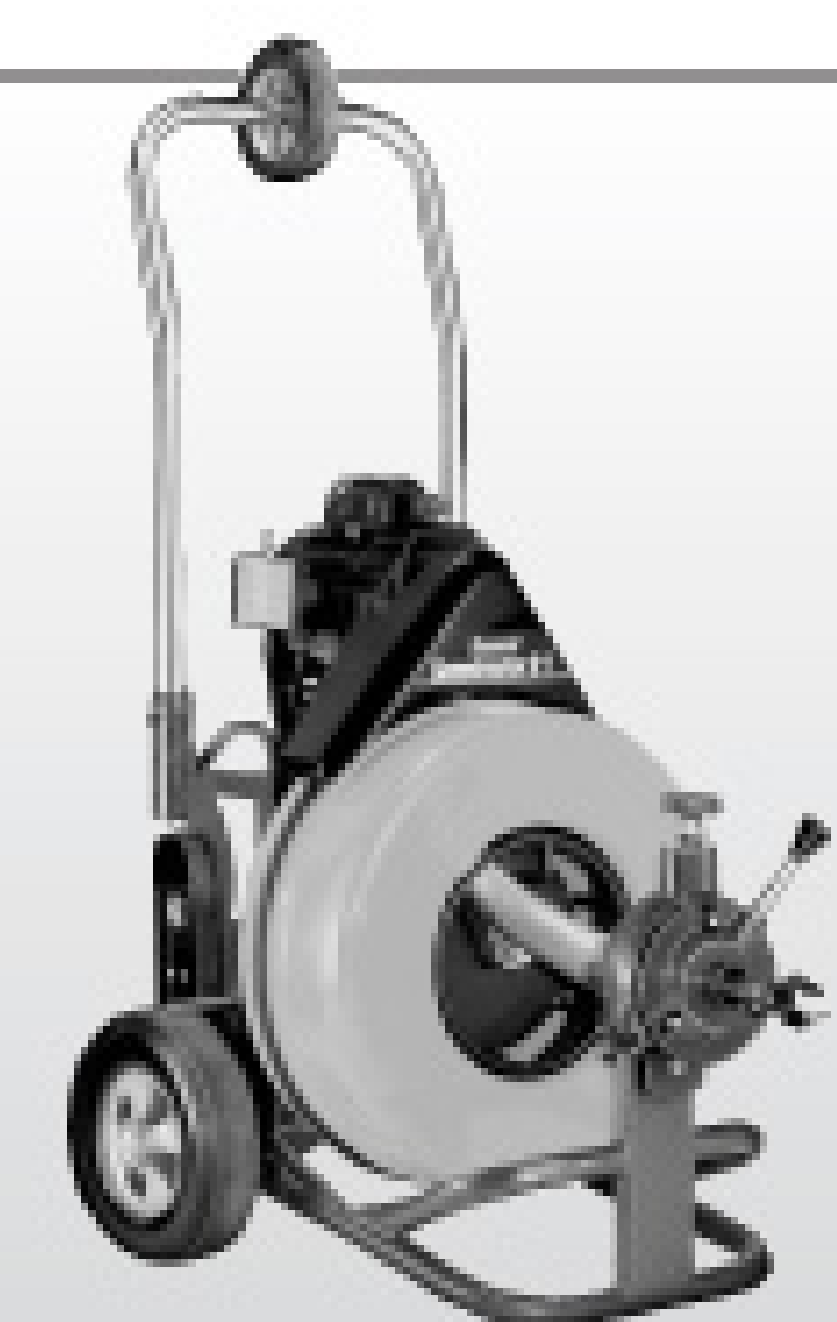

General Speedroooter 91™

Basic Unit Machine Only

\$1010

FREE DELIVERY

THE CABLE CENTER • 8318 OLIVE BLVD. • ST. LOUIS, MO 63132 • 314-993-3099

Change is Good

Here is some practical advice on how you can make your business prosper, even when the market or economy is changing and times are hard

By Anne Houlihan

Many business owners and managers feel their industry is changing rapidly, and they think it's more difficult to do business today than it was just a few years ago.

Certainly, the nightly news is full of stories about industry after industry facing financial setbacks, employee shortages, and increased competition. But just because some companies are struggling to get ahead, the same doesn't have to happen to you.

In fact, if you take a new look at your company and your situation, you may find many opportunities for growth and success. The key is to embrace rather than dread the change that is happening around you.

Let's face it: Change is scary. Life is simpler when everything remains the same: same customers, same orders, same processes, and same routines. But hidden within sameness are mediocrity and complacency — the two enemies of growth and success. If you want to come through a changing economy unscathed, you need to view your company, customers, and processes in a whole new light. To do so, consider these five guidelines for making the most of any economic challenge.

1. Focus on what you already have. Your existing customers are your No. 1 asset. Therefore, survey them and talk to them about their needs. Is there an unmet need you can fulfill? Can you make their business easier to run in some way?

A simple way to find out is simply to ask. You may discover that they have a need for an addi-

tional service you provide. Even though they've been your customer for years, they may not be familiar with all you offer.

Most of the time we sell people the same product or the same service line. In a changing economy, you need to find out what else your customers do or what else they need. Since their industry is likely changing too, they're probably changing the way they do business to stay competitive. You may just be the perfect supplier for their growing needs. But until you ask them, you'll never know.

2. Do a sales analysis on your current customers and clients. Organize your client or customer database by category. Then do a little research to determine:

- Which sectors are still growing in the changing economy?
- Which sectors are down?
- What opportunities do you have with your clients that are growing?
- How can you help clients that are struggling?

3. Examine your infrastructure. Chances are there are many inexpensive ways for you to improve and streamline your company for more efficiency. However, in the past you've simply been too busy to take notice. Now that times are changing, make sure you and your employees are using your proper procedures.

If necessary, have a meeting or training session so everyone is up to date with the efficient systems. Review each department's responsibilities and eliminate tasks that are no longer necessary.

4. Fine-tune your marketing. If you want to attract new customers, and retain current ones, you have to let them know you exist. How is your company's marketing exposure? Do you stand out from the competition? Are your customers aware of your full range of services?

A changing economy is an ideal time to tweak all your marketing messages, including your web site, your brochures, your sales letters, and even your

Anne Houlihan is president of Satori Seal and founder of Golden Key Leadership, where she combines more than 25 years of corporate experience and coaching to help companies of all sizes. She can be reached at www.GoldenKeyLeadership.com or 951/235-5405.



business cards. Granted, during a slow time many companies don't have expendable cash.

Realize, though, that you don't need to do everything yourself or start from scratch. Many business templates are available for low cost or free that can help you improve your marketing messages. These include everything from web site templates to pre-made letterhead designs. Look for and use inexpensive options that are available.

5. Conduct an overall cost analysis. Look at where you can reduce your overhead, thus showing more profit. For example, can your employees negotiate with supply providers for a better price? Can you use some local vendors and

Let's face it: Change is scary. Life is simpler when everything remains the same: same customers, same orders, same processes, and same routines. But hidden within sameness are mediocrity and complacency — the two enemies of growth and success.

virtually eliminate shipping costs? Can you get office supplies from a less expensive source?

Now is the time to challenge what you've always done and discover new ways to save money. Usually when we're busy and doing well, we don't have time for such things. Now is the time to dig deep, question everything, and find those cost savings.

While a changing economy can be a scary time, it's actually a prime time for growth. If you simply look for opportunities, you will find them. So be aware of economic changes and the potential downfalls, but don't make it your reality.

Remember, only you and the decisions you make can create your company's reality. In the end, by simply following the three P's — displaying Positive, Proactive Perseverance — you'll be amazed at how your business can grow. And you'll be glad you said "yes" to opportunity. ■

www.waterleakfinder.com

Sewerin USA

Water Leak Detection Equipment

by **PIPE TOOLS INC**

2008 Catalog Available Now

NEW USJETTING[®] NEW

ENGINEERED FOR RESULTS

THE AMAZING NEW 4018 300
SMALLER, LIGHTER, STRONGER



- New Control system with Wireless Remote
- Shorter by 18 inches. and lighter
- Central mounted 180° turn hydraulic reel
- DOT approved polyethylene fuel/antifreeze tanks
- LED lights with programmable flashing
- Protective roll cage design
- Hard stainless steel piping on all fluid systems
- Anti siphon fill system
- Original USJ run-dry pump
- All the benefits of USJetting quality and service

Available from May 2008

1-800-538-8464

www.usjetting.com



EVERYTHING YOU NEED TO KNOW ABOUT
SEWER AND DRAIN CLEANING

April classes: Dallas, Las Vegas. May classes:
Boston MA, Columbus OH, Houston TX.
Like a class in your local area? Give USJ a call.

One day courses for
service technicians,
owners, plumbers,
managers, contractors
and municipal staff

**BOOK YOUR
PLACE TODAY**
CALL
800.538.8464
ext.25

ultra *ultra* *ultra*
LIGHT – VERSATILE – SAFE

ultraSHORE PRODUCTS



Quick to Install.
 As light as 130lbs.

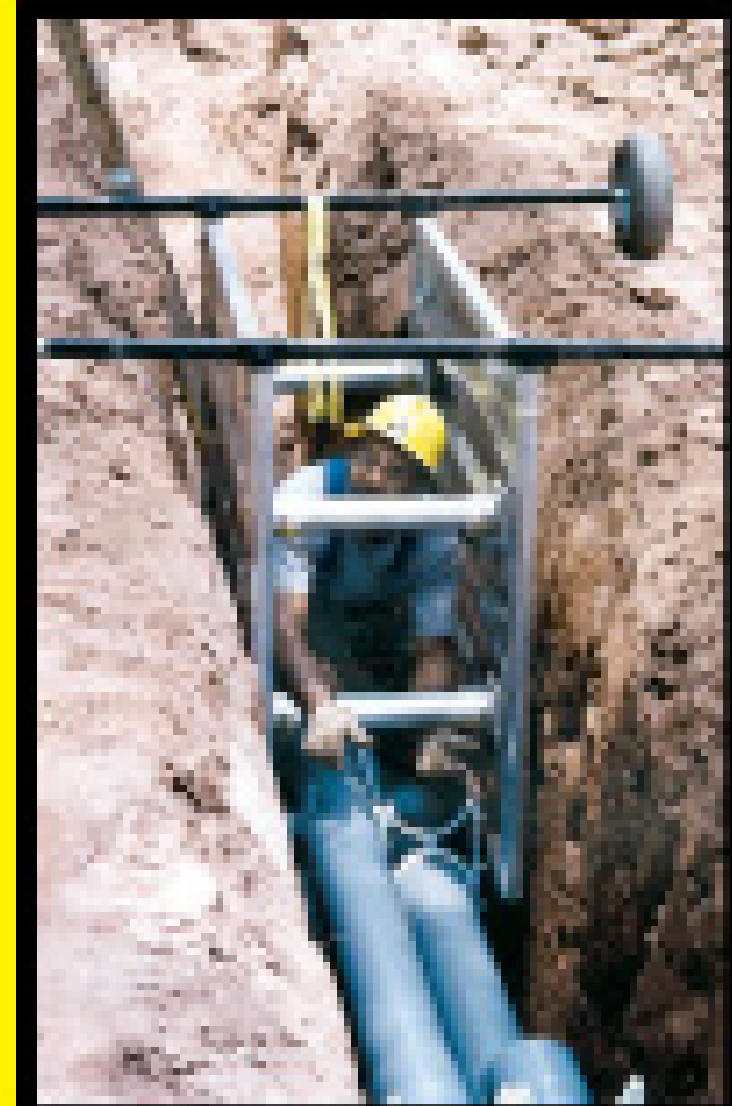

Roll Your Own.
 Optional wheel kit.



Stacks easily with
 2' & 4' high panels.

This is What Aluminum Shoring Was Meant to be!



1-800-683-8837

1-800-SH-ORING

CALL TOLL-FREE NATIONWIDE • 1-800-746-7464

www.shoring.com



Custom Drilled NOZZLES

SIX PACK KIT™



**NOW OFFERING
 JETTING HOSE!
 CALL FOR A QUOTE**

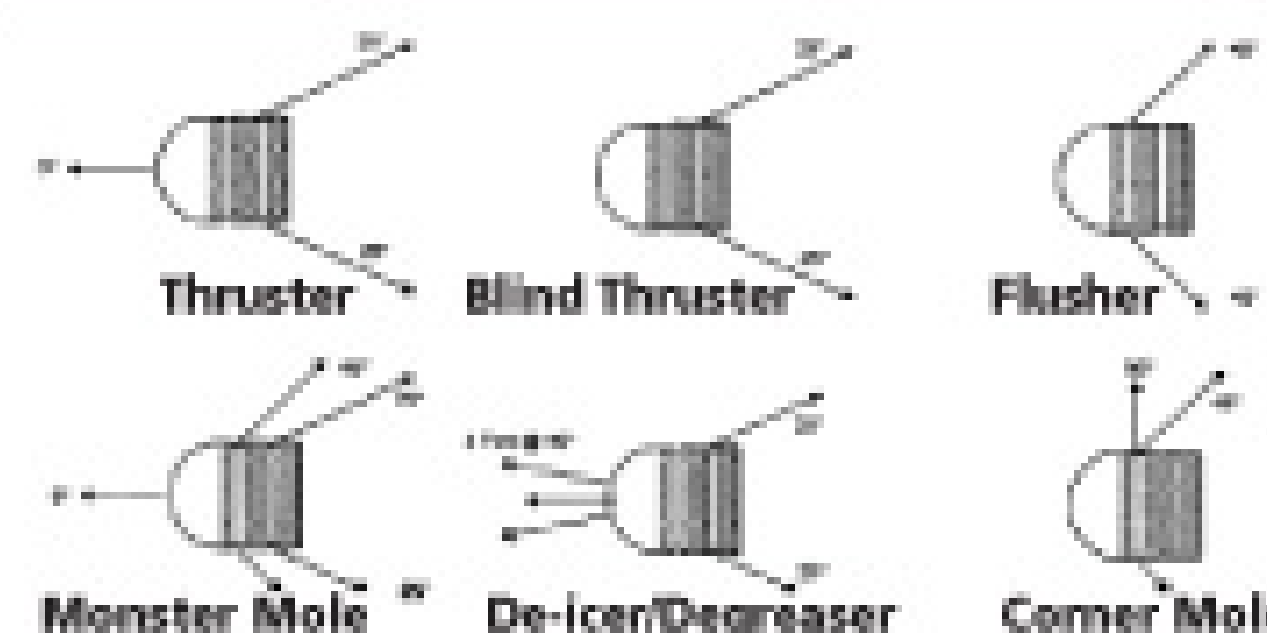

NPT Size	Price	Savings*
1/8"	\$120	\$34
1/4"	\$130	\$39
3/8"	\$140	\$41
1/2"	\$150	\$43

*Compared to individual prices

- Each nozzle is **custom drilled** to match your pump's flow and pressure specs for **optimized nozzle performance**.
- Custom drilling means **your choice of spray patterns**.
- Each nozzle is made with **heat treated 416 stainless steel** for superior corrosion and wear resistance, and rated up to 10,000 psi.
- Most orders shipped within **one business day**.
- **100% satisfaction guarantee**.

CALL TOLL FREE: 877-457-2782

North Royalton, OH 44133 • www.aquamole.com • Fax: 440-237-2987

"Your One-Stop Stopper Shop!"

FOR 31 YEARS – HOME OF THE ORIGINAL

PIPE PLUG & NB BAG/PILLOW DESIGN STOPPER

[SINGLE SIZE OR MULTI SIZE PIPE STOPPERS 4" & UP]

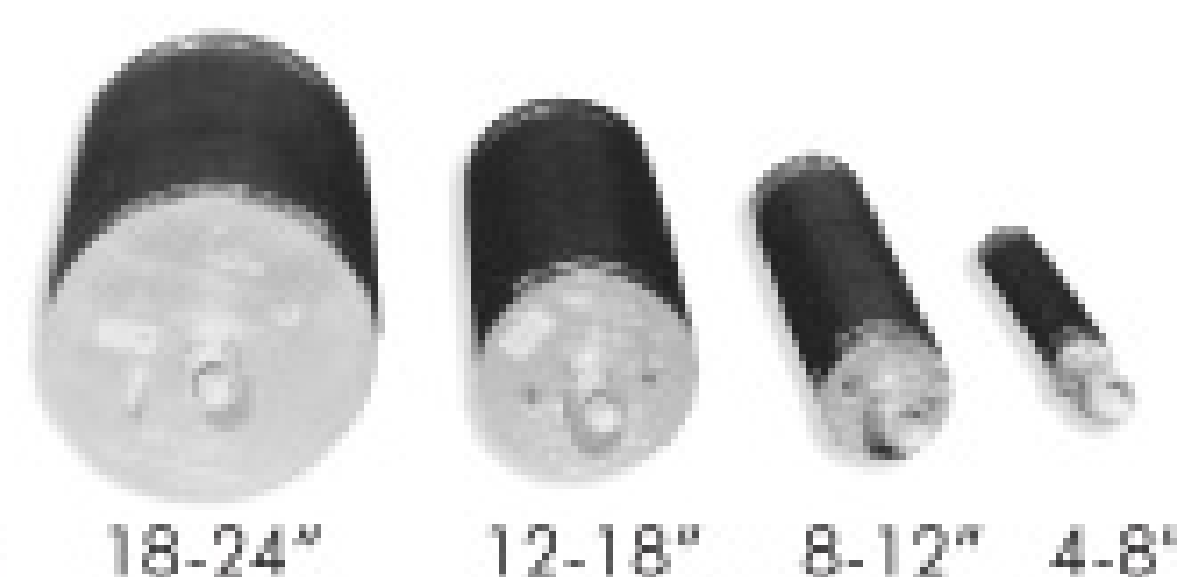

18-24" 12-18" 8-12" 4-8"

J PLUGS

- Four J-Plugs do the job of 12 plugs
- Field repairable
- Above ground installation



NB MULTI SIZE BAG/PILLOW STOPPERS

- Great for elliptical & other non-round applications
- Natural rubber construction
- Also available with Flow Thru

SINGLE & MULTI SIZE PASS THRU PLUGS



MULTI SIZE PLUGS & MULTI SIZE LEAK LOCATORS



SINGLE & MULTI SIZE TEST PLUGS



COMPLETE LINE OF SEWER & DRAINAGE TOOLS AVAILABLE

disc plugs | high pressure plugs | large inflatable pipe plugs | pipeline testing & acceptance plugs | pneumatic by-pass plugs

SEWER EQUIPMENT CO. OF FLORIDA, INC.

P.O. BOX 186 | 1102 N. DIXIE FREEWAY | NEW SMYRNA BEACH, FL 32170-0186 USA

IN FLORIDA 800.225.2952 | OUT OF FLORIDA 800.635.2323 | IN CANADA 800.328.3318

FAX 386.427.4552 | E-MAIL sewerequip@worldnet.att.net | WEB SITE www.sewerequipmentco.com

COMPLETE LINE OF SEWER MAINTENANCE TOOLS



It's easy to be cheaper. It's harder to be better!

OLDEST NAME IN THE BUSINESS
— Over 100 YEARS OLD —



NEW
SeekTech®
SR-60

NOW AVAILABLE

RIDGID's new line of locating equipment meets the most demanding needs of the locating professional. Built to make even difficult locates easy, SeekTech is the only line locator that uses omnidirectional antennas, guidance arrows and an easy to read mapping display to lead you quickly and accurately to the target line.

SeeSnake® micro™

The new RIDGID® SeeSnake micro inspection camera allows you to easily perform visual inspections in hard to reach areas. Its lightweight, handheld design means that it can be carried anywhere – providing solutions when and where you need them, while allowing you to offer more services and increase productivity.



RIDGID®

THE BEST SERVICE AT PRICES TOO LOW TO LIST!

RIDGID®



SeeSnake

**ALL SeeSnakes
NOW INCLUDE 512 HZ
TRANSMITTERS**

**DVD NOW
AVAILABLE
ON SEESNAKE
IN-STOCK**

**Factory Repair
for SeeSnake**



SPECIAL PRICES ON THE NEW RIDGID SCOUT® IN STOCK!

Allan J. Coleman Co., Since 1905 - CALL US TODAY! 773-728-2400

"THESE PRODUCTS ARE SO GOOD, WE GIVE YOU OUR ADDRESS!"

5725 North Ravenswood Avenue • Chicago, IL 60660 • www.allanjcoleman.com

PHCC MEMBER

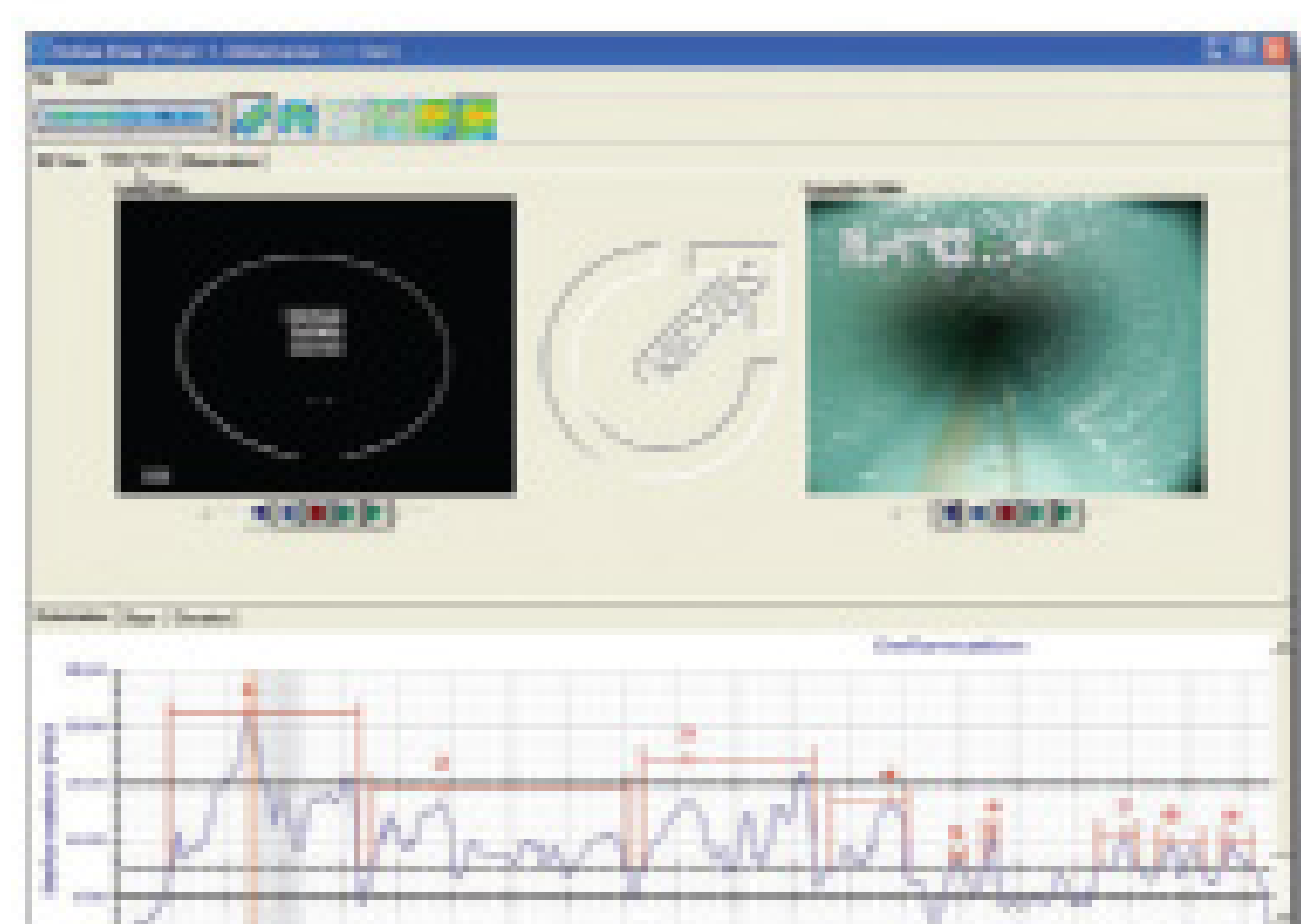
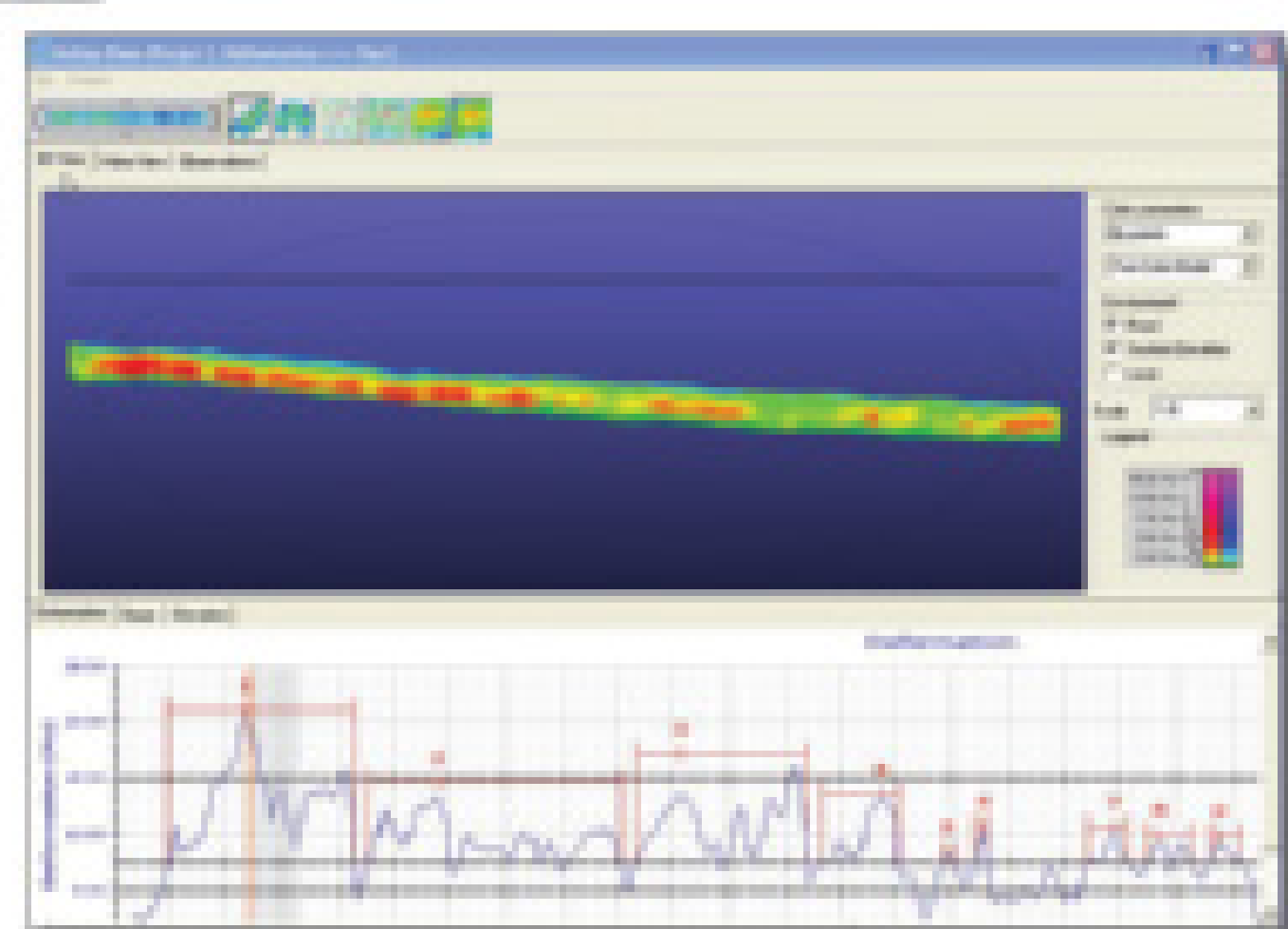

No.	Start (ft)	End (ft)	Depth (ft)	Profile	Stk. Title	Low temp	High temp
1	121	138	67	127	14%		
1	142	150	48	158	33%		
1	173	207	60	200	78%		
4	300	402	16	403	32%		
1	408	459	62	420	75%		

3D LASER Profiler

For pipelines 8" to 48"

From the engineering innovators in pipeline inspection technology, RS Technical Services presents Cool Vision™.

- ▶ 60,000 measurement points per second
- ▶ accuracy of 0.25%
- ▶ System features encoded wheels for precise distance measurement
- ▶ Fixed laser optical triangulation
- ▶ Pinpoint defects with 3D Modeling
- ▶ Generate easy to understand interactive reports

800 767 1974
sales.info@rstechserv.com
www.rstechserv.com

WHEN YOU REALLY NEED A WORK TRUCK NOW!

1-800-822-8785

www.fssolutionsgroup.com



ID #26707, 1999 Vactor 2110, Roots 824 Blower, Automatic Transmission

NICELY EQUIPPED!



ID #25135, 1998 King Vac 3000 USG, Moro Vane Pump, New Tires

READY TO WORK!



ID #24468, Clean Earth Safe Vac, Roots 1024 Blower, New Paint

READY TO WORK!

Many More Units Available • Call for Details!

Parts and Service
Financing for Used Equipment and Service
Warranties for Most Equipment
We Sell and Service

The Largest Selection of Refurbished Vacuum Trucks in the World



We've got you covered



FS Solutions™

Your Resource for Used Equipment Sales,
Service, Parts and Rentals*

From the people who bring you Guzzler, Jetstream and Vactor, the brands you know and trust, we bring you FS Solutions.

These FS Solutions centers are staffed with skilled, factory-trained technicians and provide a range of services and product offerings.

- **High-performance** parts for most makes and models of industrial vacuum loaders and waterblasters
- **Wide range of accessories** for industrial cleaning operations
- **Repairing and rebuilding** of equipment, pumps, blowers and more
- Large selection of **refurbished vacuum trucks**
- **Jetstream waterblast rental units** ranging from 170-300 HP, pressures convertible from 10-20-40k psi.

And now, we have a new full service FS Solution center location in Long Beach, CA, to serve our customers in the west.

More locations for your convenience

Birmingham, AL

8584 Borden Ave. SE
Leeds, AL 35094
800/822-8785

Houston, TX

2500 E. Pasadena Freeway
Pasadena, TX 77506
713/472-1529

Streator, IL

1621 S. Illinois St.
Streator, IL 61364
800/822-8785

Toledo, OH

1144 Expressway Drive South
Toledo, OH 43608
888/415-RENT (7368)

Long Beach, CA

NEW FULL SERVICE LOCATION!
1510 Hayes Ave.
Long Beach, CA 90813
866/515-9891

* Offerings vary by location.



GUZZLER
Subsidiary of Federal Signal Corporation



Jetstream
Subsidiary of Federal Signal Corporation



VACTOR
Subsidiary of Federal Signal Corporation

FS SOLUTIONS™
SALES • RENTALS • PARTS • SERVICE



Mass Sewer & Drain owner Kenny Litalien and technician Barry Nelson prepare a Flexiprobe P330 system from Pearpoint for an inspection. The company has made inroads to its market with an emphasis on inspection and locating. (KarwanPhotos.com)

Subterranean Sleuth

Locating and inspection devices help a suburban Boston contractor solve customer's sewer pipe mysteries and build up profitable lines of business

By Erik Gunn

Kenny Litalien might call himself a drain cleaner, but he's really a gumshoe.

When customers have sewer-line mysteries, Litalien loves puzzling out the answers.

Over the last 10 years he has built a thriving drain-cleaning and inspection business, Mass Sewer & Drain, in suburban Boston. But things really took off about four years ago when he began to offer line locating.

Locating is a challenge that delights, but he shied away from it for years — until he found equipment that he liked. “When you’re wrong, it’s expensive,” he says. A new locating system he bought a few years ago turned him around.

Today, pipe inspection accounts for 10 percent of his work, and locating buried sanitary and storm sewer lines makes up another five percent. Those numbers may seem small, but they mask the bigger significance of the work. Inspection and locating help him level the playing field against larger, brand-name franchises.

“Right now it’s just a way to take care of the customers we already have,” says Litalien. “It keeps the customer onboard. It keeps them from looking for someone else.”

He doesn’t believe it needs to stop there. As his knowledge deepens, and as more of his nine employees learn to use the equipment, Litalien expects inspection and locating to grow by leaps and bounds. He thinks it could easily generate a half-million dollars a year someday.



The Flexiprobe P330 monitor screen shows a pipe inspection in progress.

High school memories

Litalien entered the drain cleaning business while in high school, as an employee of Metro Sewer Service in Woburn, Mass. “My boss used to pick me up after school,” he says. “I quit school in the 11th grade to work for that guy.”

After five years, he went out on his own, starting Mass Sewer & Drain. (Mass for Massachusetts). About five years ago, he bought his old employer and folded that business into Mass Sewer, holding on to

PROFILE

MASS SEWER & DRAIN WOBURN, MASS.

OWNER: Kenny Litalien
FOUNDED: 1998
SPECIALTIES: Sewer line locating, drain cleaning, pipe inspection
EMPLOYEES: 9
ANNUAL REVENUE: \$1.3 million



both company names to keep the brand recognition Metro Sewer built over its 30-year history.

Inspection has always been part of Litalien's offering. He started with a camera from Scooter Video Inspection Systems, switched to Electric Eel equipment, and more recently turned to the Flexiprobe system from Pearpoint Inc. He likes

“It’s unusual to run from the septic tank in. If I had run from the building out, we would never have seen the open cleanout.”

Kenny Litalien

its image clarity and the built-in sonde, which works well with his Schonstedt locating equipment.

Back when Litalien was a Metro Sewer employee, the business did some locating, and he accompanied work crews as a helper. He wasn't impressed with the hit-and-miss results. “That’s expensive when you’re opening up a main road within a city,” he says.

He credits supplier Jim Fay of Pipe Tools in Pennsauken, N.J., with changing his mind. “I started buying my equipment through him five or six years ago,” Litalien says. His first purchases were cameras. Then he tried Schonstedt locating gear.

Try, try again

Litalien entered the locating business when a local restaurant customer experienced frequent sewer line backups. “Every time it rained heavily, they’d get flooded out,” he says. The solution was to put in a check valve, but the line had to be inspected first to make sure there were no other tie-ins to it, and the location needed to be precise so that he could install the check valve with the minimum of disruption.

“A couple of companies had been in before us trying to locate a 5-inch sanitary sewer leaving the building,” he says. “It was about 25 feet to the city sewer line — just a sidewalk and a street.”

When his first attempt to locate the line failed, Litalien called Fay, who let him borrow a Schonstedt XT512 unit. “The Schonstedt nailed it,” he says. He put off buying the unit, but then had to turn another

customer down because he lacked locating equipment. At that point, he made the purchase.

The XT512 locator stands alongside a full complement of investigative gear. Litalien uses a Pearpoint Flexiprobe P330 camera with a 200-foot reel and a standard 512 Hz sonde in the camera head. He also

uses a drain cleaning machine from Electric Eel Mfg. that uses 8-foot sections of dual cable and 6-foot sections of C cable.

When a camera won't fit, he uses a Prototek sonde, which he nicknamed “the Blue Bullet.” He can attach it to the Electric Eel cable and send it in. “Then we use the Schonstedt to

BUILDING THE TEAM

Mass Sewer & Drain employs nine people, but only two of them, owner Kenny Litalien and employee Joe Martell, do locating and inspection.

“The rest of the guys only do drains,” Litalien says. The reason is simple: training. His video and locating devices are sophisticated and delicate instruments. He wants his crew to know how to use them properly before sending them out and risking damage that could set back his business.

Martell has begun riding along with Litalien to learn more about the locator. Another veteran employee will follow. “These guys need to see five or six camera jobs, and then they'll be able to do it,” Litalien says. “I'll give each one a Pearpoint camera and a Schonstedt locator, and I'll come back to the office to sell the service.” Restaurants are a big source of business, and inspection helps drive sales. “You send the camera down the line, and show the customer a picture of a 4-inch line with a half-inch opening just clogged with grease,” Litalien says. “You go in with a snake; it's like a brand-new pipe.”

Once he has the employees trained, Litalien plans to develop a before-and-after video with scenes like that to help market his inspection and drain-cleaning services. He also has his eye on the home-inspection market.



Kenny Litalien uses a Schonstedt XT512 locator to find the head of the Flexiprobe P330 camera inspection system in a sewer pipe on a Boston street. Inset, Litalien spray-paints the spot after a successful locate.

chase the bullet," he says.

For smaller cleaning jobs — drains smaller than two inches — he uses a Super Vee drain cleaner from General Pipe Cleaners and a Hande drain cleaner from Electric Eel. Both have 35-foot, 3/8 inch cables. He also has a 600-gallon trailer-mounted water jet unit from US Jetting and eight service trucks: two Chevy Astro Vans and six Ford Econoline E-250 vans.

Detective case file

Like any good detective, Litalien has a file full of successful closed cases. Some of the most noteworthy have seen him follow up on problems that have stumped other contractors. Not long ago, the operators of a chain drugstore in Rhode Island had reached the end of their rope. The store had been plagued by an odor and a backed-up sewer line.

“When you shut down a supermarket at night to dig, you can’t be running into unexpected sewer lines.”

Kenny Litalien

Another contractor had already snaked the drains. “They got it clear, but one of the guys got the cable stuck,” Litalien says.

Litalien brought along his Pearpoint camera, but instead of sending it into the line and out of the store from the inside, he went the other way: from the store’s septic tank, through the line, and into the store.

“I saw the camera go past the snake blade and then climb up the wall” inside the pipe,” he says. Then on the video screen he saw the culprit: an uncapped cleanout in the sewer line, buried in the wall.

“I found the cleanout on the

video, but I couldn’t figure out where it was,” he says. Using the camera’s built-in sonde and his Schonstedt locator, Litalien pinpointed the problem, and the store’s contractors were able to solve it. “They opened up the wall and put the cap back on,” he says.

Litalien says his unorthodox approach made the difference. “It’s unusual to run from the septic tank in,” he says. “If I had run from the building out, we would never have seen the open cleanout.”

Success breeds success

Success stories like that one have opened up lots of opportunities for Mass Sewer. On a grocery store remodeling job, Litalien was called in to locate three sanitary sewer lines as precisely as possible. The remodelers were working at night so the store could stay open during the

day, and accuracy was key: “When you shut down a supermarket at night to dig, you can’t be running into unexpected sewer lines,” Litalien says.

Another from the case file: A 25-story high-rise in downtown Boston had a clogged roof drain. “The management company had called in the plumbers before us,” Litalien says. “They were running their snakes to find where the roof drain was clogged.”

One of the men on the job knew of Mass Sewer’s locating abilities. Other plumbers there were skeptical and told Litalien when he arrived that he needn’t bother. But using his sonde and locator, he tracked the



Camera inspection and locating make a powerful pair of services for Mass Sewer & Drain. Owner Kenny Litalien and technician Barry Nelson find the Flexiprobe P330 camera highly portable.

blockage to a spot in the wall in the basement about seven feet up from the bottom floor — behind a concrete wall that had to be opened up for the repair.

The basement room where the repair was done held computer equipment for the building. “It was a major overhaul, and if I was wrong, forget it,” he says.

Yet another job was at New England Baptist Hospital, where general contractors adding a new wing called on Mass Sewer as a subcontractor. The project included new roof drains. Mass Sewer had to inspect the storm sewer running from the hospital to the street and locate all of catch basins. The hospital’s hilltop location added to the challenge.

“It was probably the hardest locator job I’ve ever had to do,” Litalien says. “We could hardly walk on the hill, it was so muddy.” Running the camera through from inside the building out to the main line, Litalien identified the locations of three catch basins and used the camera to discover some bad tie-ins and broken pipe. “Once I found them with the camera, we had to locate them so they would know where to dig,” he says.

That job pushed the equipment to its limits. “You can locate anything as long as it’s not too deep — 12 feet or so,” Litalien says. On the hospital job some of the lines were as far as 15 to 18 feet underground. “We still located them, but it was very, very hard because the signal was so faint.”

Missing ring

The locating story Litalien likes best is the mystery of the missing

diamond ring. A long-time residential customer in Lexington, Mass., had dropped the ring down a toilet. Litalien put his camera into the sewer line from behind the house.

“Just as we were coming into the basement, there it was,” he says. Workers established the exact point, cut open the hardwood floor, and extracted the ring from the line. The customer called a local TV station, and a news crew filmed a re-enactment.

Publicity like that is free — and priceless. And with stories like that to tell, Litalien is looking ahead to the day when all that sophisticated gear uncovers a lot more business as expertly as it detects sewer lines and clogs. ■

Save your back with the “SNAKE HANDLER”



- Electric sewer snake loader
- It is fast rugged and dependable
- Field tested for over 5 years
- E Z to install for side door applications, still leaves plenty of room for access
- Loads to curb or street
- Works with most snakes
- Locks snake secure for transport

\$1,195 plus shipping & handling
batteries not included

PHONE 707-643-6002

demo video on our website
web.mac.com/petez2

MORE INFO:

Electric Eel Manufacturing Co.

800/833-1212
www.electriceel.com

General Pipe Cleaners

800/245-6200
www.drainbrain.com

Pearpoint

760/343-7350
www.pearpoint.com

Schonstedt Instrument Co.

800/999-8280
www.schonstedt.com

Scooter Video Inspection Systems

800/772-6165
www.tvinspection.com

US Jetting LLC

800/538-8464
www.usjetting.com

It's Time To Trade In Your Non-Compliant Data System



Imagine...

... a simple, fast and accurate Data Collection System, more efficient for your operators than you ever thought possible, fully debugged with no costly upgrades. **Imagine** an integrated PACP manual at your operators' fingertips prompting correct data entry every time, saving time/money by eliminating QA/QC editing. **Imagine** a Data Collection System with no more "Gotcha's".

Stop imagining!

Stop paying tens of thousands of dollars for constant upgrades and more bugs. Put your data problems behind you. Replace your non-compliant system with a CobraTouch™ CDL 9000 Series Data Logger and CIMS™ Data Management Software.

During the month of April trade in your non-compliant data system for a PACP Certified CobraTouch™ system. Call us today or visit our website for details on this special upgrade offer.

You'll be glad you did!



www.cobratec.com

4806 Wright Drive Bldg. C
Smyrna, GA 30082

Sales: 800.443.3761
E-mail: sales@cobratec.com

KMH EQUIPMENT COMPANY

SALES • RENTALS • SERVICE

KMH Equipment has many well maintained quality trucks and equipment for sale or for daily, weekly, or monthly rental. Financing Available

PRESVAC



- Vacuum Trucks
- Combination Trucks
- Hydro Excavators
- Jetters
- DOT Certified Trucks
- Sweepers



VACALL™

Phone 1.888.KMH.0202

www.kmhequip.com

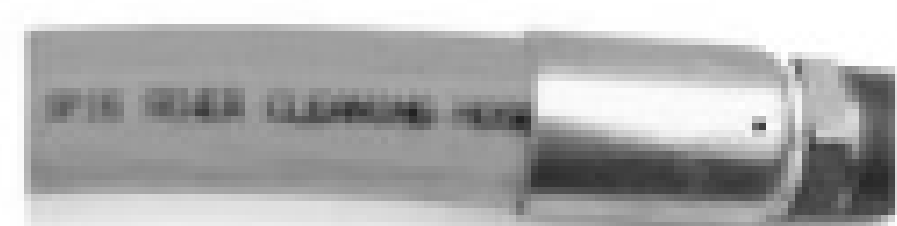

Jetter Hose



Hydraulic Swage
Die Sets & Pusher
\$925.00

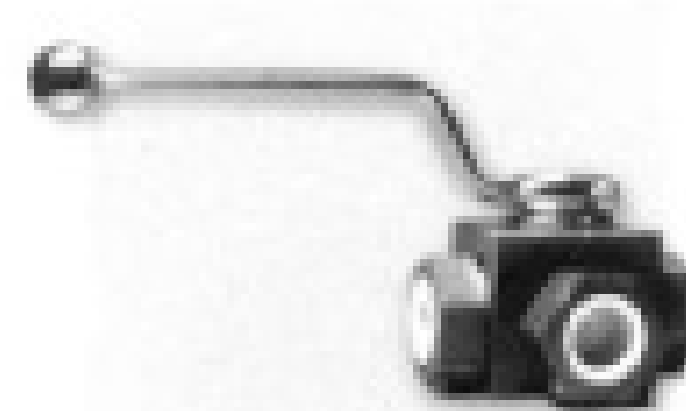

High Pressure
Valves
3/4", 1", 1-1/4"
2 Way Ball Valve
3 Way Ball Valve

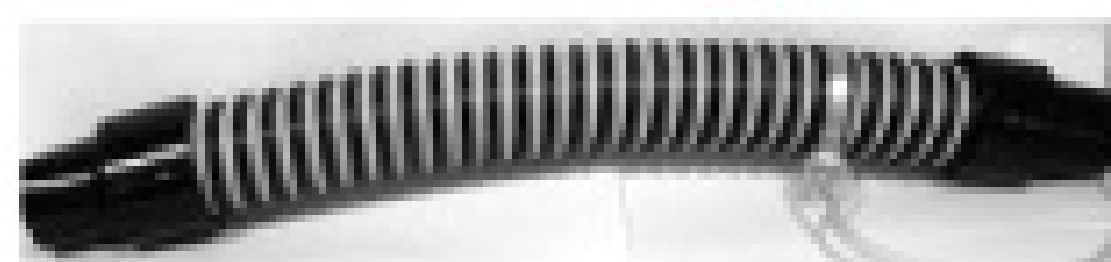
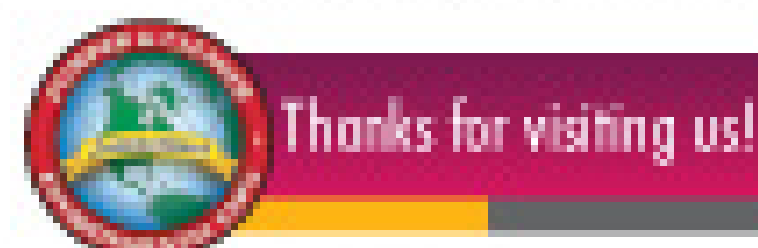

Tiger Tails

Chattanooga, Tennessee info@epasales.com

EPA ENVIRONMENTAL PRODUCTS & ACCESSORIES

866-448-5547 FAX 423-876-4389

PRICES ONLINE!

www.epasales.com

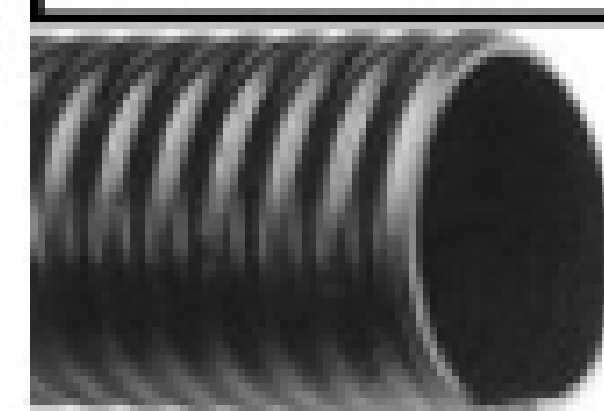

Kanaflex®
Suction Hose for
Vacuum Trucks



Lever Valves
Brass

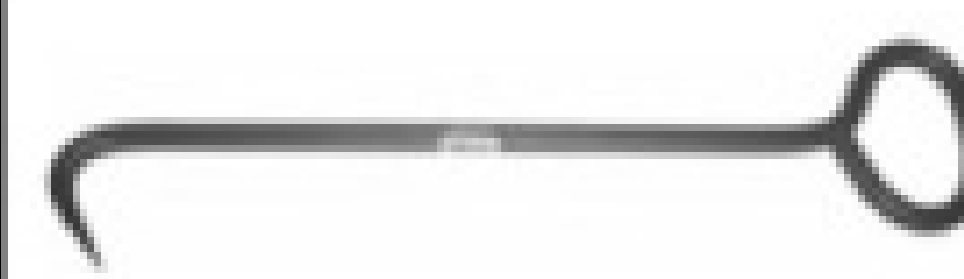

Manhole Hook
\$28.00



Hydrant Wrench
\$14.95



Piston Valve
Brass
6" NPT \$190.00
6" Flange \$199.00

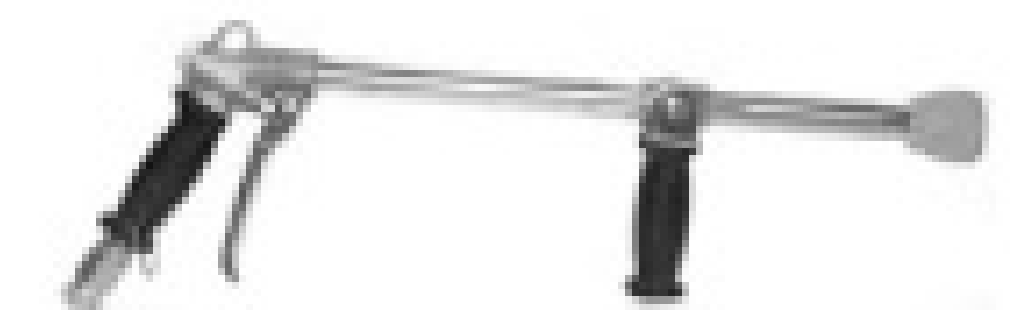

Washdown Guns
Adjustable Spray Pattern
Cone to Stream Shape



Cam-Lock
Duct Cap DC
3" DC \$7.40
4" DC \$10.40
6" DC \$28.00



Cam-Lock
Reducer
3" to 2" \$20.00
4" to 3" \$29.00
6" to 4" \$55.00



Hose Reel
Swivels
3/4", 1", 1 1/4"

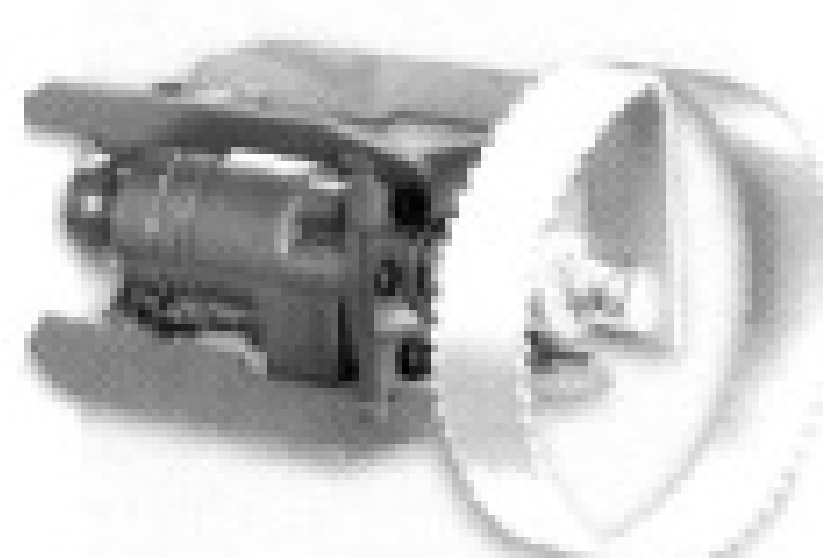

Root Cutters

NEW!!!

BUY ONLINE!

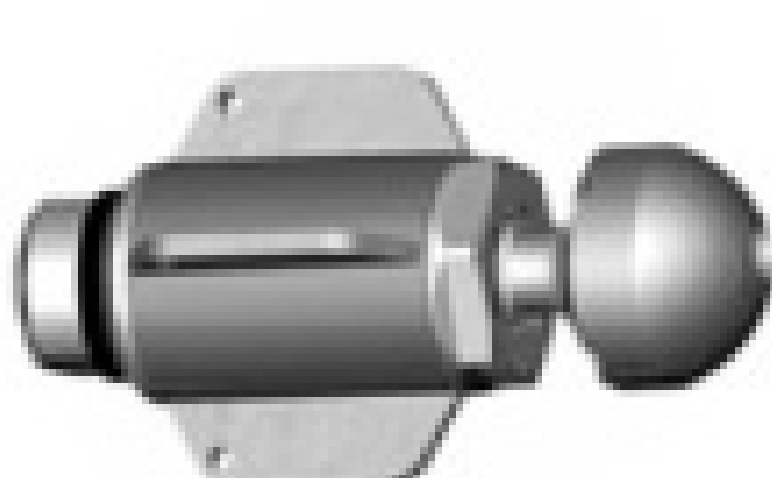

Warthog
Rotating Nozzles



Chain Cutters



Catch Basin
Flange * Crown



Aluminum Tube



Aluminum Tube
Aqua-Latch Couplers



Tube Handle
Easy Clamp Onto
Outside of Tube



Pipe Plugs



Hydrant Hose

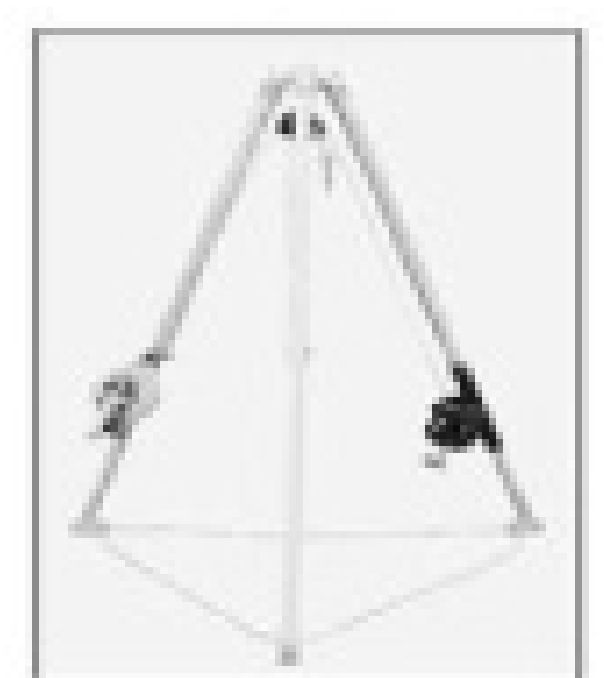

Fall Protection
Tripod & Winch
\$1,775.00



MyTana

Thanks for stopping by
our booth in Louisville

Introducing
two **NEW**
Cable Machines...



M500
The Colt

M888
The Upright Workhorse

Contact us for your **FREE** full line catalog today!
Toll Free: 800-328-8170
Fax: 651-222-1739
Visit: www.mytana.com

Pulsar 2000

Line Tracer

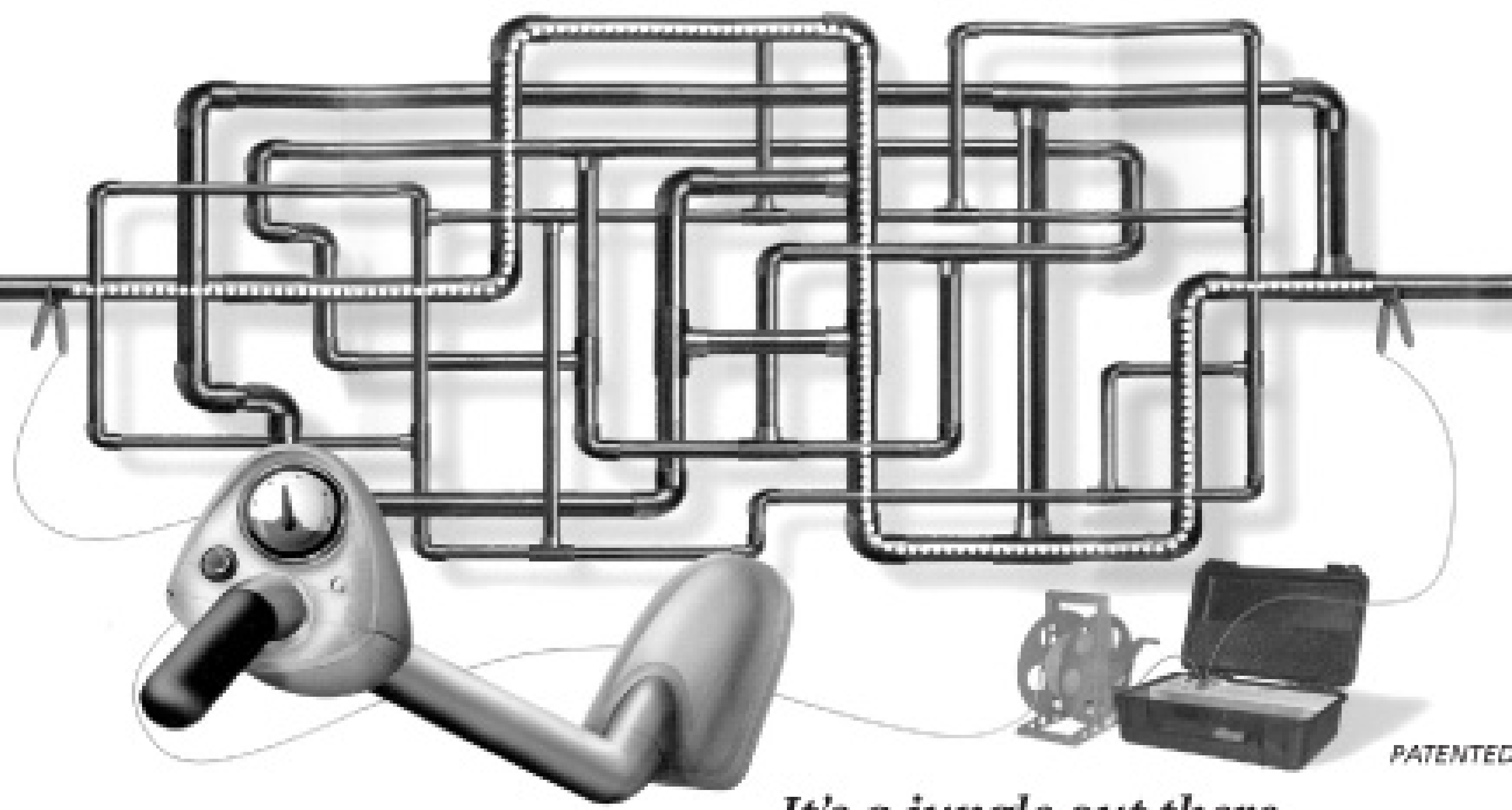

It's a jungle out there.

Locate Lines • Locate Water Leaks • Training Video

www.Pulsar2000.com

DISTRIBUTORS WANTED

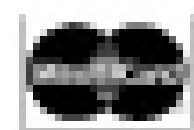

The Pulsar 2000 line tracer is designed primarily to locate metallic pipes. The Pulsar 2000 is a directional line tracer. Connect the Pulsar's powerful and unique transmitter to your target pipe and locate only that pipe. Locating can be accomplished under floors, in walls and in ceilings. The Pulsar 2000 does not require grounding.

Leak detection personnel... The Pulsar 2000 is a **must have** locator. Now you can quickly identify the pipe location, thereby reducing the search area of the leak.

100% satisfaction guarantee... We are so sure that you will see the time saving benefit of the Pulsar 2000, we will let you return it for a full refund if you are not satisfied. If you want to learn more about the Pulsar 2000 and our leak locating equipment, please call **1-888-752-5463** or e-mail jsmll@aol.com for a **free** demonstration video or CD and references of satisfied customers.

We have been using the Pulsar 2000 along with the XL2 fluid detector and Geophones since January 1989 in our leak locating business. Our leak locates are **accurate 95% of the time**, but I can honestly say, the line we trace is always there. Our equipment is user-friendly and requires very little training, as you will see on the video. Purchase the Pulsar 2000 line tracer, XL2 fluid detector and Geophones, and start locating leaks immediately.



**If this was your home...
Would you dig?**

Since we are a stocking distributor
we can offer you special pricing!

**GIVE US A CHANCE TO QUOTE YOU ON
YOUR NEXT REHAB PRODUCT PURCHASE!**

We are Committed to Earn Your Business!! Call Us Today!!

Toll Free: (877) 409-7888 • International: (407) 772-8131 • Visit Our Website: www.primelineproducts.com

Lateral Lining ~ Manhole Rehabilitation ~ Chemical Grouts ~ Internal Seals ~ Concrete Restoration Products ~ Epoxy Materials ~ Testing Equipment



PRIMELINE PRODUCTS, INC.

"Your Prime Source for Solutions, Products & Training"

MAXLINER®

PRIMELINER® / MaxLiner® Lateral Lining

PRIMELINER® uses an engineered composite made of a felt tube and an epoxy ambient cure resin to invert a liner into the lateral from the property line or cleanout to the connection with the sewer line, forming a "pipe within a pipe" to effectively repair broken pipe, leaking joints and other infiltrating defects in the lateral pipe.



Manhole/Wetwell
Rehabilitation
Products



de neef

> Fast Setting Plug
Materials

> Spray Mortars

> Epoxy Coatings

> Concrete Restoration
Products

> Waterstop Materials

> Urethane Grouts

> Acrylate Grouts

> Grout Pumps

> Expansion Joint
Materials

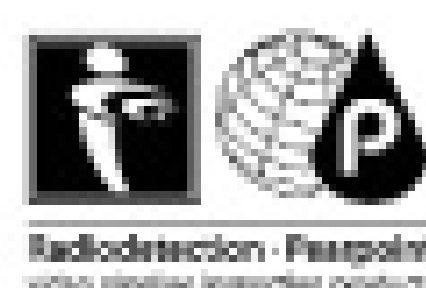

We are now
a Pearpoint
Distributor!

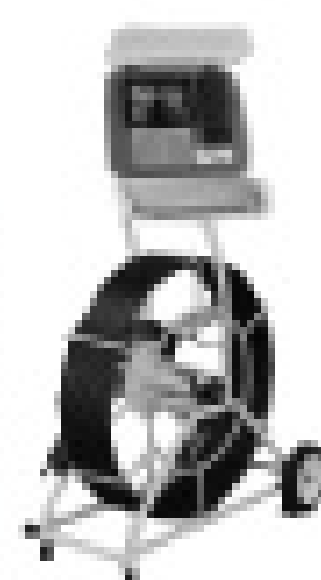

**Plugs, Smoke Testing,
Joint Testing Equipment!!**



CHEMIE UNDERGROUND PRODUCTS



40,000 psi



24,000 psi



15,000 psi



10,000 psi



Get all your favorite features, at any pressure.

60-second cartridge change, instant pressure dump, and more

When designing our latest lances and foot controls, we got advice from experts: operators who use water jets every day.

As a result, NLB's 60-second cartridge seal change and patented instant pressure dump are now standard on 11 lances and 4 foot controls — 10,000 to 40,000 psi — with no trade-off in performance or comfort.

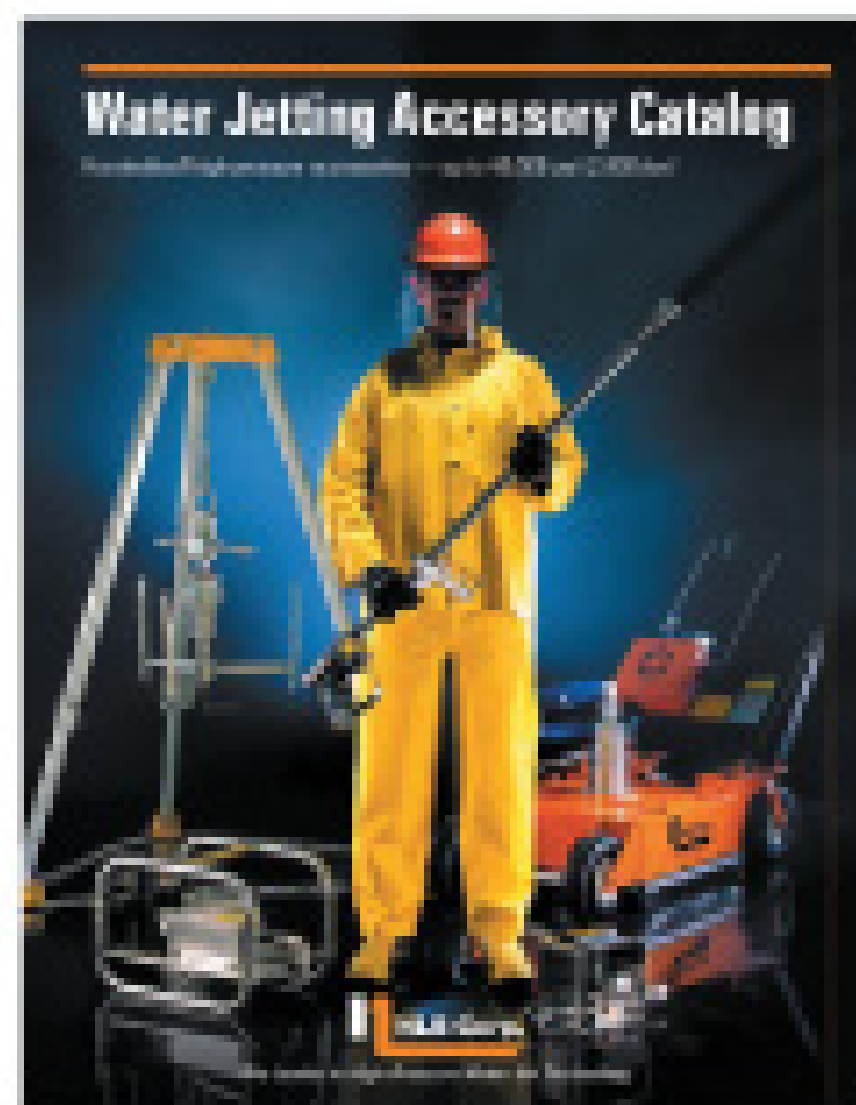

We also offer these great features on some SPIN-NOZZLE® heads, multi-gun valves and Bi-Mode™ valves. They're all in our updated accessory catalog, available at **1-877-NLB-7988** and www.nlbcorp.com.

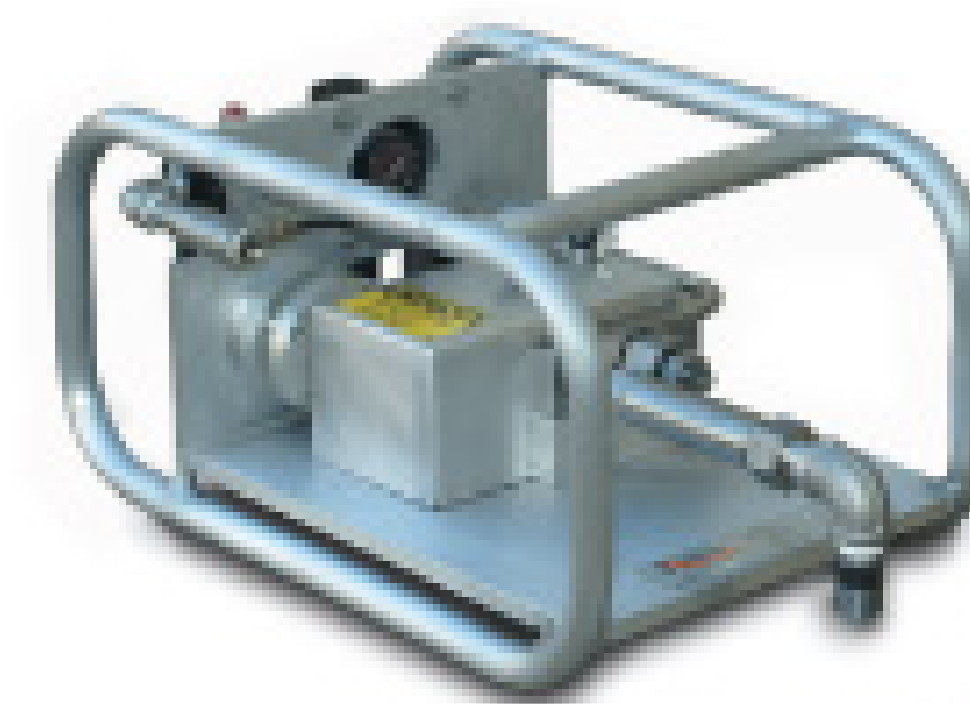

Bi-Mode™
Valve

MGV15-3000
Multi-Gun
Valve



SRH40-77
Viper 40™

NLB. The Contractor's Choice.



29830 Beck Road, Wixom, MI 48393
MI: (248) 624-5555, TX: (281) 471-7761
NJ: (856) 423-2211, LA: (225) 622-1666
CA: (562) 490-3277
e-mail: nlbmktg@nlbusa.com

Introducing the
Kleen-Vue
 Cleaning + Wireless
 Video in One Unit!

Cleaning and video capabilities in one unit? Quite a concept. Until now, done only with a hardwired system. Combining KEG's patented **wireless** technology with KEG's patented **fluid mechanics**, the **Kleen-Vue** sends a **wireless** signal to the operator for real time video and documentation of pipe conditions, as the unit is being cleaned. **It's not magic, it's the Kleen-Vue!**

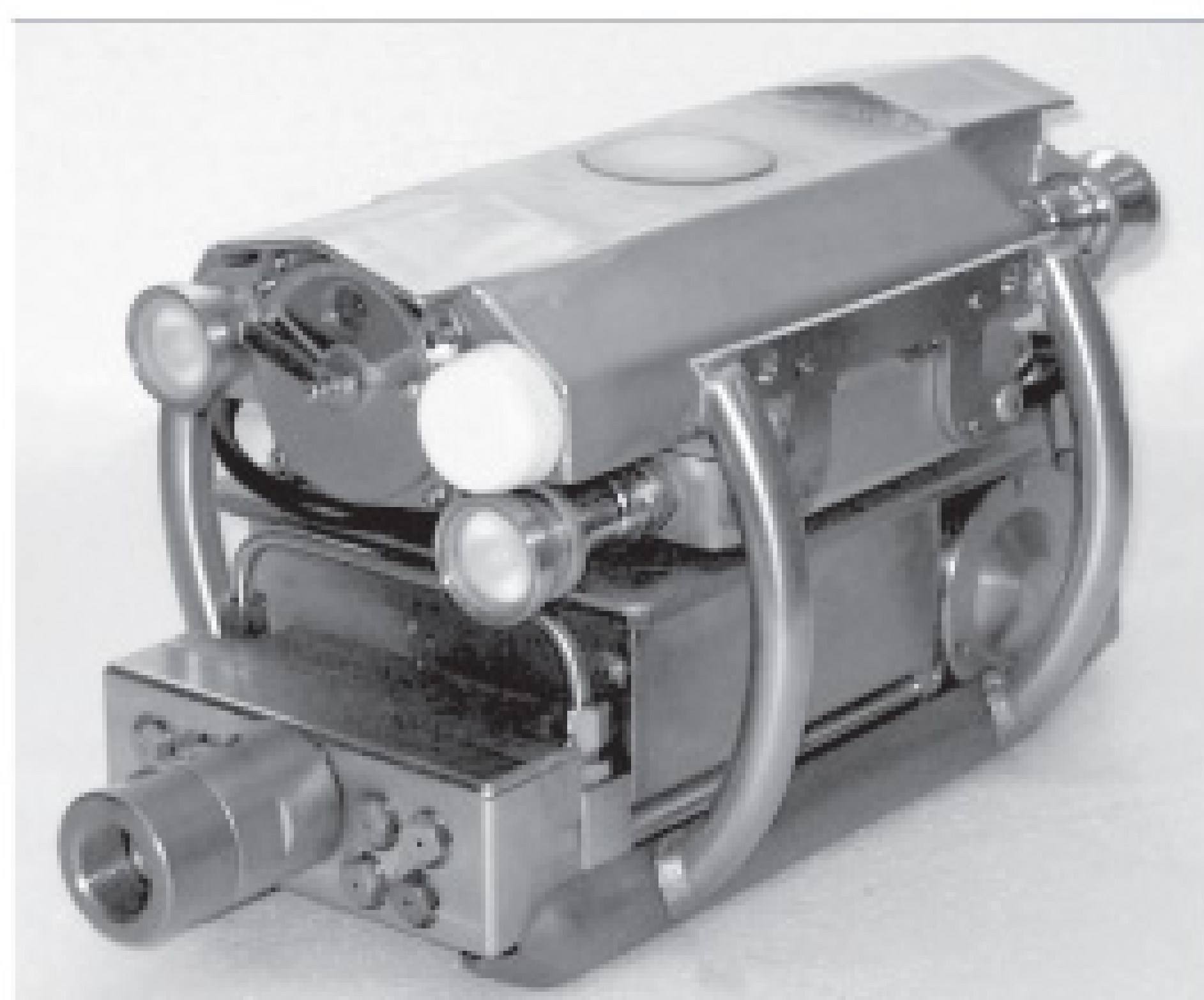

KEG Technologies, Inc.

P.O. Box 3067
 Madison, MS 39130

866.595.0515 toll free

www.kegtechnologies.net

US Patents:
 5992432,
 6138697



FSI FLUID SYSTEMS, INC.

Specializing in Parts & Service for High Pressure Water Pumps
 Used on Sewer & Catch Basin Cleaning Units



PARTS FOR PISTON & PLUNGER POWER PUMPS
 INQUIRE ABOUT PUMP TRADE-IN PROGRAM
 SHOP OR FIELD SERVICE

1-800-880-5800

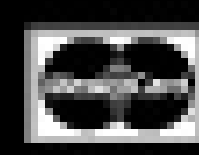

FAX: 812-428-7061



E-MAIL: don@fluidsystems.net • WEB SITE: www.fluidsystems.net

Trap-Cleer

Quality Sells ~ Sell the Best

Are you making **MONEY?**

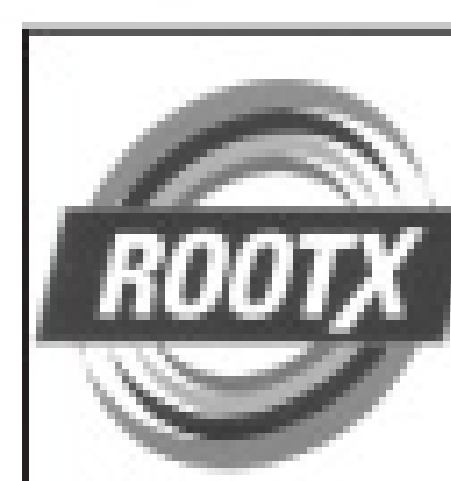

Products to BEAT all Competitors Pricing!

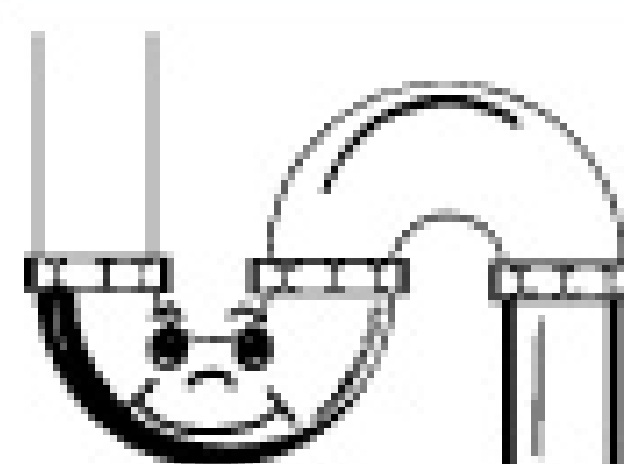

Call Today for Your **FREE** Sample

1-800-223-3083

920-826-4083 • Lenzyme, Inc.

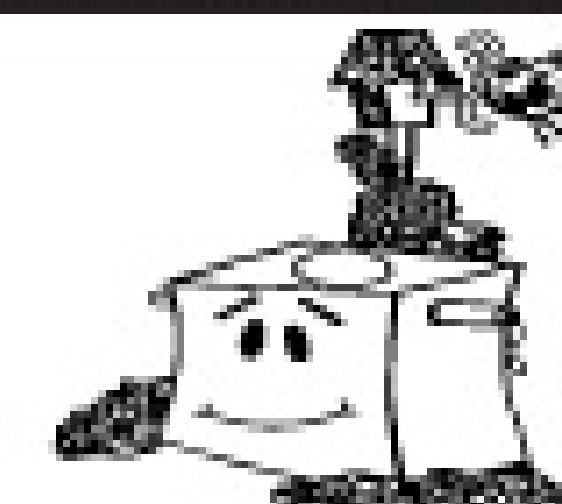

Grease and Waste Solutions

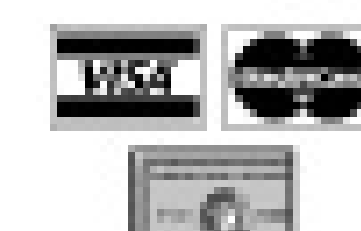

Gen-Ear LE™

WATER LEAK LOCATION SYSTEM

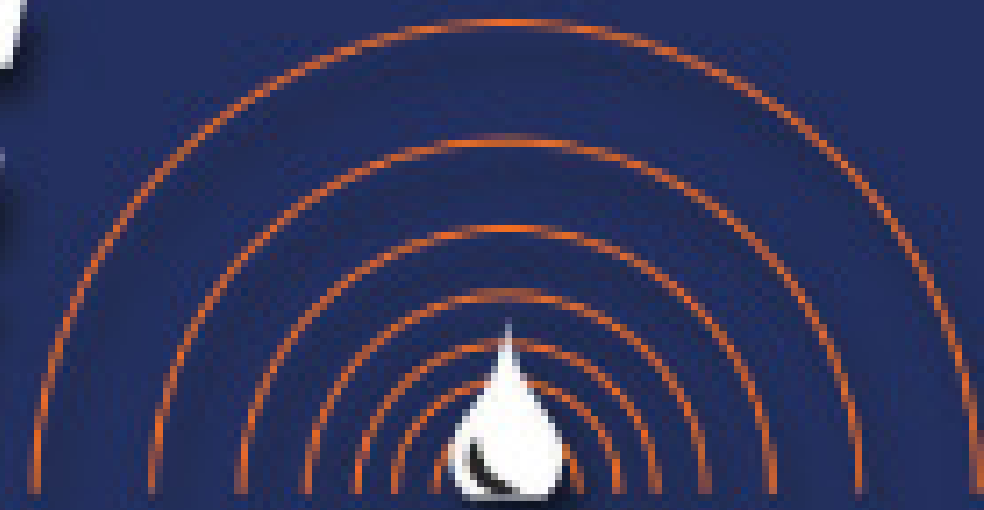

Just
\$1950
Complete

Sound Investment

Now, a smaller investment gets you a better method for tracking down water leaks. The Gen-Ear LE is a simplified, more economical tool with stronger sound amplification than other systems. Use it to pinpoint water leaks in residential and commercial water lines, whether they are under concrete slabs, in walls, swimming pools or hot tubs.

The compact amplifier with mute button fits in the palm of your hand. It provides noise free amplification with built-in preset audio filters, so you don't have to guess what settings to use.



And the high performance David Clark® headphones with noise cancellation features block out interference from ambient noise.

Hard to find leaks get a boost with the Sound Amplification Manifold. It helps amplify hard to hear leaks by using air to pressurize the water line, making leak location easier. The Gen-Ear LE will save you a lot of guesswork and unnecessary digging. And that saves you a lot of money.

For quick information, call the Drain Brains® at 800-245-6200 or 412-771-6300, or visit www.drainbrain.com/genear



General
PIPE CLEANERS
www.drainbrain.com

The toughest tools down the line.™

© General Wire Spring 2008

Mr. Rooter Plumbing of St. Croix Valley is located 15 miles from the Minnesota border and serves three counties in western Wisconsin and one in eastern Minnesota. Technician Kim Hudson and co-owner Allen Lewerer are shown on a remote job site. (Photography by Casey Lake)



New Name, Same Face

A local plumber finds that taking on a national drain cleaning franchise requires adjustments — in equipment, pricing, and approaches to dealing with customers

By Erik Gunn

Talk about shifting gears. Allen Lewerer grew up in the western Wisconsin community where he still lives and works, but when he opened his shop a year ago he was the new guy in town.

After nearly three decades of doing mostly new construction plumbing, he was taking on a new niche: service plumbing. And accustomed to working just for his father in a small, local shop, he now finds himself part of a national operation as a Mr. Rooter affiliate. He has no regrets about any of it.

Lewerer, 46, operates Mr. Rooter of St. Croix Valley out of New Richmond, Wis., serving three counties in Wisconsin and one in eastern Minnesota. He is optimistic about the road ahead, and he has already begun mapping out new directions for his business.

"Pretty much the future is completely open right now," he says.

Construction to service

The Mr. Rooter business opened in 2006, but it grew out of the long-

time plumbing business owned by his father, Dave Lewerer. Richmond Plumbing and Heating Inc. has been in business for more than 30 years, and Al has worked for the company since he finished high school 28 years ago.

Richmond Plumbing has focused on new home plumbing for most of its history. "My dad did a lot of the service work himself," Al Lewerer says. "Occasionally he'd have me do the remodeling and other service work, too." But as father and son

looked at the changing landscape, they noticed something.

"We saw the new construction field being competitive," the younger Lewerer says. "This area needed a plumbing service company. We saw the opportunities Mr. Rooter offered."

So they obtained franchise rights for Mr. Rooter in the area and set up the new company with Al Lewerer in charge. Located 15 miles from the Minnesota border and 40 miles from the Twin Cities, the company is one of three Mr. Rooter franchises that

touch the Minneapolis-St. Paul area.

There were plenty of changes to get used to. One was being part of a large franchise organization. While that took a little getting used to, Lewerer mostly appreciates the strength and support in numbers. "My dad started as a plumber in the Twin Cities area and learned a lot of things on his own," Lewerer says. The Mr. Rooter network offers plenty of support, available online and on demand.

"Usually I'm checking it daily just

PROFILE

MR. ROOTER PLUMBING OF ST. CROIX VALLEY NEW RICHMOND, WIS.

OWNERS:	Allen and Roxy Lewerer, David and Evelyn Lewerer
FOUNDED:	2006
SERVICE AREA:	Four counties
EMPLOYEES:	6
SPECIALTIES:	Drain cleaning, video inspection
WEB SITE:	www.mrrooter.com/StCroixValley



“We saw the new construction field being competitive. This area needed a plumbing service company.”

Al Lewerer

to see if anyone’s posting a question that I could learn from,” he says. “When you’re pulling from over 225 franchises in the United States and Canada, that helps tremendously.”

Making adjustments

Customers and prospects had to adjust, too: They needed to know that behind the new corporate name was a familiar local face. “People are hesitant when there’s a new company,” Lewerer says. “Once they realize who we are, and they find out we are mainly a family-run business, that puts them quite a bit at ease.”

Still another adjustment was adapting to the Mr. Rooter standard of flat-rate pricing. “New construction is mainly bidding,” Lewerer says. “Flat rate was a whole new concept. It’s been a learning curve, but I see the value in it.” Flat rates were mostly a new idea around the area, but customers seemed to like it.

“It makes the customer feel a lot more at ease when you go over everything, diagnose the problem and tell how much it’s going to cost them,” Lewerer says.

Lewerer’s part of the world presents some distinctive plumbing challenges. They include working in older homes with older pipes and tree-root intrusion and, in winter, frozen water and sewer lines. That’s part of what has Lewerer thinking about the future.

“One of my hopes in the next couple of years is to take on a pipe relining system,” he says. “I’ve talked to a lot of city utility workers, and they’re all very interested in that type of an idea, because they’re seeing a need for it.” In the meantime, Lewerer has plenty to do. His service fleet includes a pair of Ford E-350 Super Duty vans with box bodies.

His inspection and cleaning tools include a MyTana M81 mainline machine, an M661 drain machine, and an M20 jetter that delivers 1,500 psi. Cameras include a MyTana color mainline unit and a RIDGID SeeSnake Micro unit.

“I’m a firm believer in, once you cable it, send a video down the pipe to inspect it,” Lewerer says.

The location of MyTana Manufacturing Company Inc. in nearby

St. Paul is one reason Lewerer likes that company’s products. “If something breaks down, we don’t have the time delay of having to ship it,” he says. “We can drive it over there and pick it up.”

Computer savvy

A computer hobbyist, Lewerer has built the computers for his business. He does digital video editing on the computer, and he brought that skill to his work. “I’m recording most of the sewer camera jobs I do on VHS tape,” he says. “When customers ask for a copy, I digitize it in the computer and actually burn it on

Kim Hudson uses two-way communication to check back with the office after completing a work order.

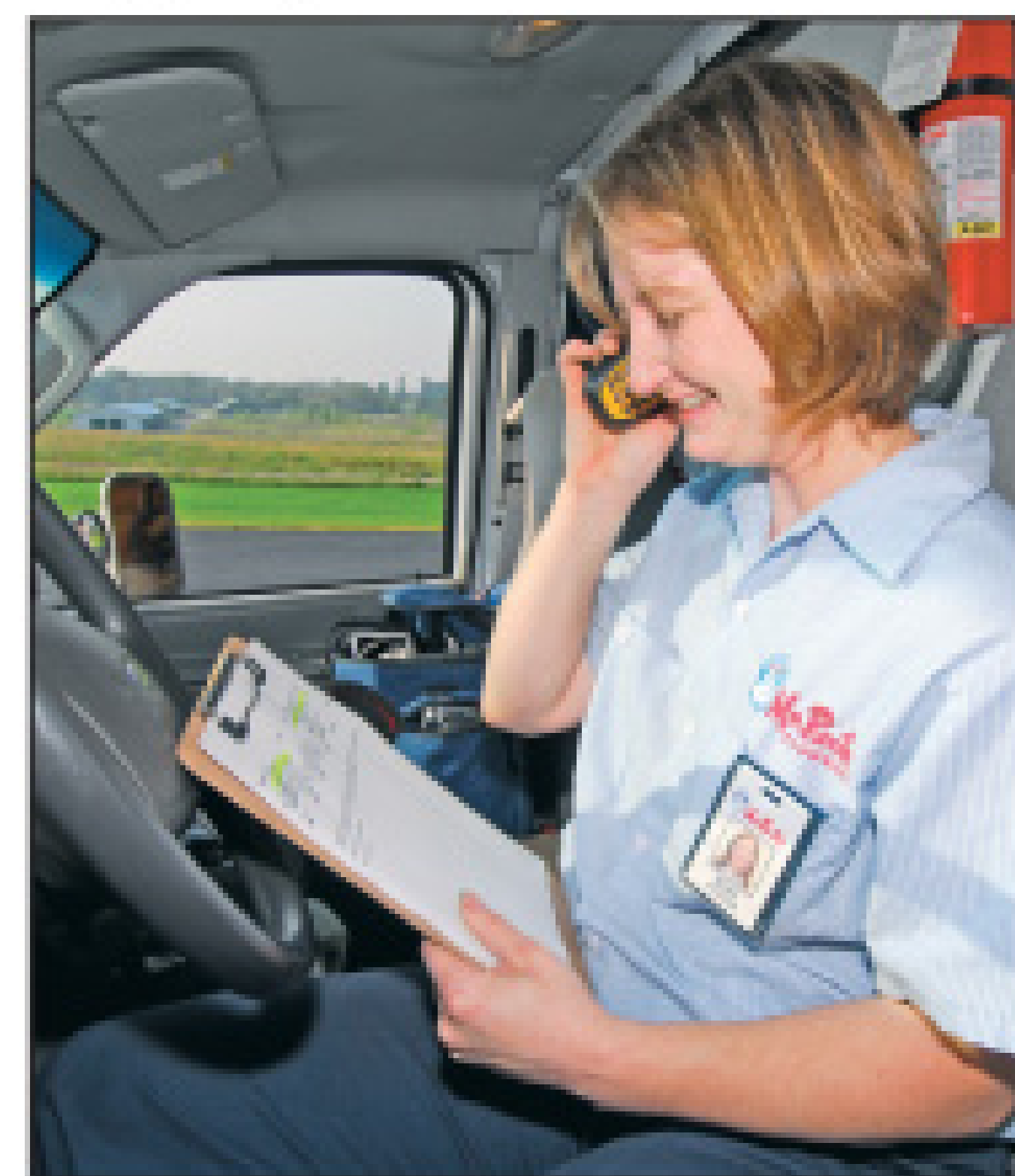

Allen Lewerer opened Mr. Rooter of St. Croix Valley in 2006. The company grew out of the longtime family business, Richmond Plumbing and Heating Inc., founded by Al’s dad, Dave Lewerer, more than 30 years ago. Family members pictured are (from left) Allen’s step-daughter Kim Hudson, his wife, Roxy, Al, his mother, Evelyn, his father, Dave, and step-daughter Sally Vruno.

A FAMILY AFFAIR

Al Lewerer got into the plumbing trade through his father, Dave, and now he is passing it down to the next generation.

Al’s wife, Roxy, handles clerical duties part time for Mr. Rooter Plumbing of St. Croix Valley. His youngest step-daughter, Sally Vruno, fields customer calls and schedules visits as a customer service representative. His other step-daughter, Kim Hudson, is completing her fourth year of apprenticeship to become a licensed plumber. Even his father helps out on some of the service calls.

Lewerer and Roxy attended the 2007 Pumper & Cleaner Expo in Nashville. Having their daughters in charge in their absence made that easier. “Kim took all the calls the week we were gone,” Lewerer says.

As the business grows, and as Lewerer gets ready to slow down, he hopes to pass the business on to the next generation. “Working with family can be rewarding,” he says. “You see your family members growing in their knowledge and their skills, and you know it’s helping them in their life.”

Located 40 miles from the Twin Cities, Mr. Rooter of St. Croix Valley can drop off or pick up equipment from MyTana Manufacturing Company Inc. in St. Paul.

THE PROVEN LEADER IN WATERJETTING EQUIPMENT

PUMPS & UNITS

- From 100 to 750 HP
- Pressures from 5,000 to 50,000 PSI
- Trailer or Skid Mounted
- Diesel or Electric



ENGINEERED PRODUCTS

- Shellside Machines
- Rotary Line Cleaners
- Cutting Equipment
- Air Preheater Tools



WATER JETTING TOOLS

- Nozzles
- Control Guns
- Valves
- Fittings
- Waterblast Hoses
- Rigid & Flex Lances

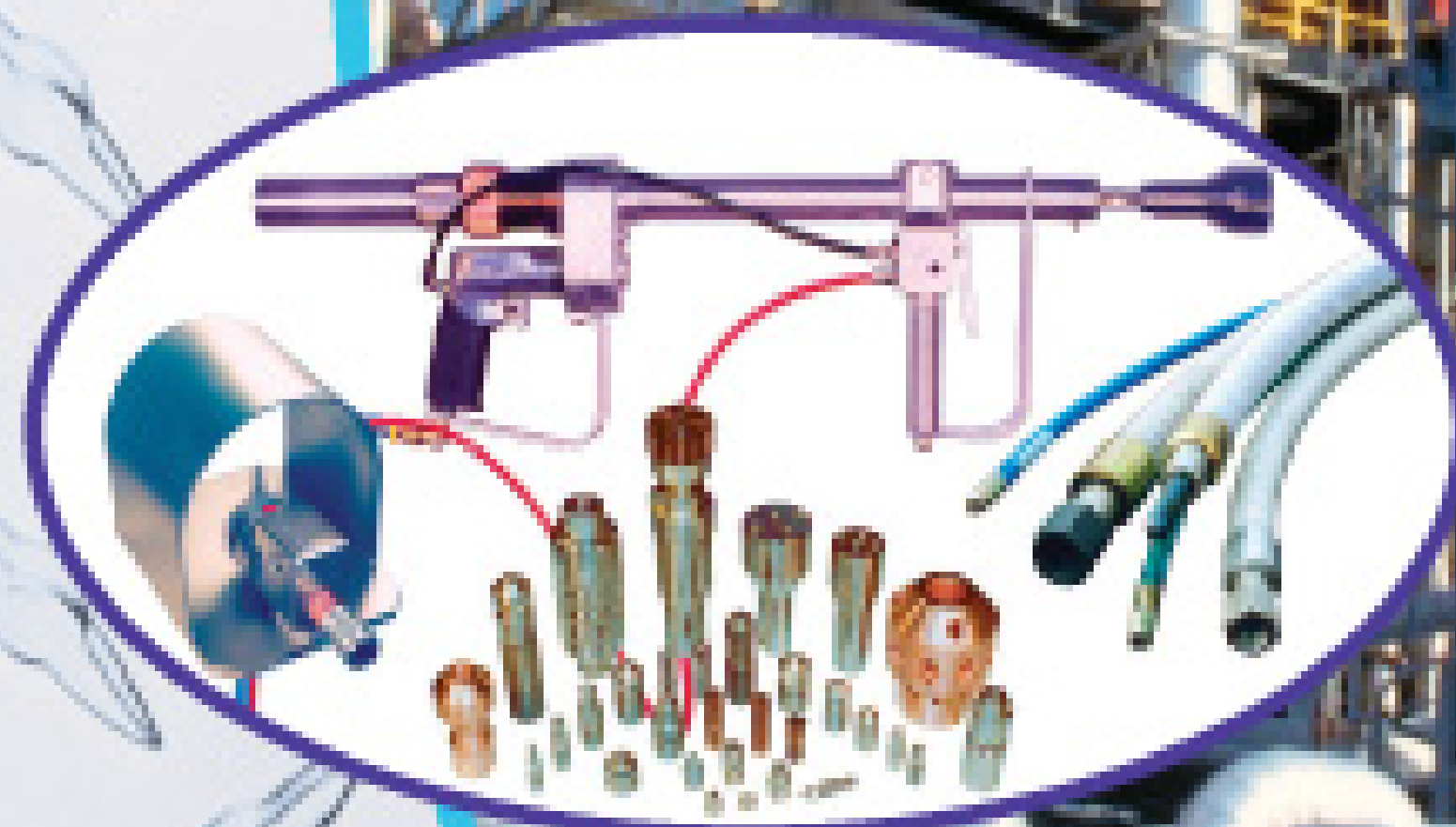

GARDNER DENVER WATER JETTING SYSTEMS INC.

281-448-5800 • Fax: 281-448-7500
1-800-231-3628

www.waterjetting.com

E-mail: mktg.wjs@gardnerdenver.com

to a DVD."

When he inspected a sewer line for a local church, he produced a DVD and handed it over "so their board of directors could see how I wanted to handle it," Lewerer says. He dubbed a narration on the recording and branded it with a Mr. Rooter logo.

Video work helps customers not just at the moment but in the future, he reasons. On one call, the camera revealed cracks in a customer's sewer line from invading tree roots near where the line tied into the city sewer main. "I put it on a DVD and mailed it to them so they could take it to the city utility department and ask who is responsible," he says. "Now they can plan for their future and how to deal with it."

He also collects still images from jobs to use in training employees. "I carry a digital still camera with me in my diagnostic bag," Lewerer says. "I take pictures of things that are broken or have gone wrong to build up a library. When I have future employees, I can show them pictures of the problems."

Always on call

Tied in with the new flat-rate pricing structure is the principle of around-the-clock service. "Mr. Rooter is a 24/7 company, with the idea of making it more convenient for the homeowner," Lewerer says.

He finds his customers like that as well. "They don't have to take off of work in the middle of the day," he says. "If it's in the evening, it's in the

"You're always in the business mode as an owner because you're always thinking about it. How you would handle a situation. How you would handle something so it's fair to the customer."

Al Lewerer

evening, and there's no extra charge." Of course, that means demands on his time. "I went out Christmas Eve and I went out New Year's Eve for main lines that were plugged," he says. "I knew I made their holiday better because I solved the problem for them."

Just how many hours a week does he spend on the business? Lewerer chuckles at the question. "I've been afraid to add them up, actually," he confesses. "You're always in the business mode as an owner because you're always thinking about it. How you would handle a situation. How you would handle something so it's fair to the customer."

Solving problems is a major reason he went into the business. "Mainly I'm a hands-on type of person," Lewerer says. "I like to be able to work with my hands, and I like to help people. I like mechanical things and I like trouble-shooting things. I feel good when I can solve problems. It seems like a natural fit." ■



Allen Lewerer takes step-by-step photos on jobsites. The photos are used during training to show new technicians how a job should be done. Here, he downloads photos from his camera to his computer. A computer hobbyist, Lewerer built and maintains all the computers in his office.

MORE INFO:

MyTana Mfg. Company, Inc.

800/328-8170

www.mytana.com

RIDGID

800/769-7743

www.ridgid.com

Leaders in cutting technology.

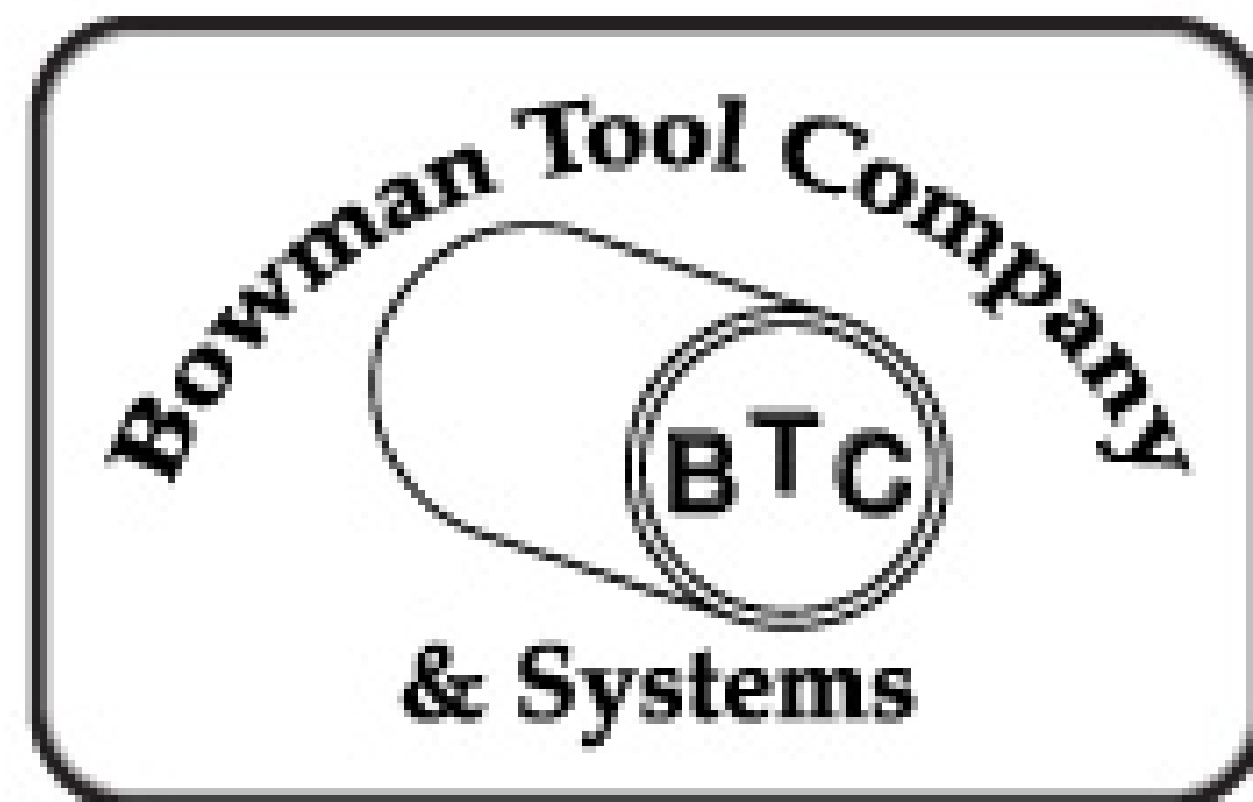

Call Us About
The New Dominator 300
Series Cutter For Working
In 4-Inch Relined Pipe!!



717-432-1403
Fax: 717-432-0152

- » Dominator® Cutters
- » Classic 615's Repair Parts
- » Rugged Jumbo 1236 Cutters
- » Generation II Infinite Controls
- » Redesigned Air Motors

We are a service-minded company. Call us for a demonstration of the unmistakable Dominator® with a range of 4-30" and powered by the smaller, quicker Generation II Infinite Control.

FREE TRAINING AT OUR FACILITY ON OUR PRODUCTS!
Do you own a Trytek or Aries cutter with leakage issues? We offer a remanufacturing program for those cutters as well as air motors.
CALL US FOR DETAILS!

bowmantoolco@earthlink.net • www.bowmantool.com

TrakMats®

Ground Cover Mats For The Professional

- * UV protected
- * Tough, Lightweight
- * Power Cylinder Cleats
- * Hand cutouts for lifting
- * 100% Recycled Material
- * Unaffected by heat & cold
- * Light color prevent burnt grass

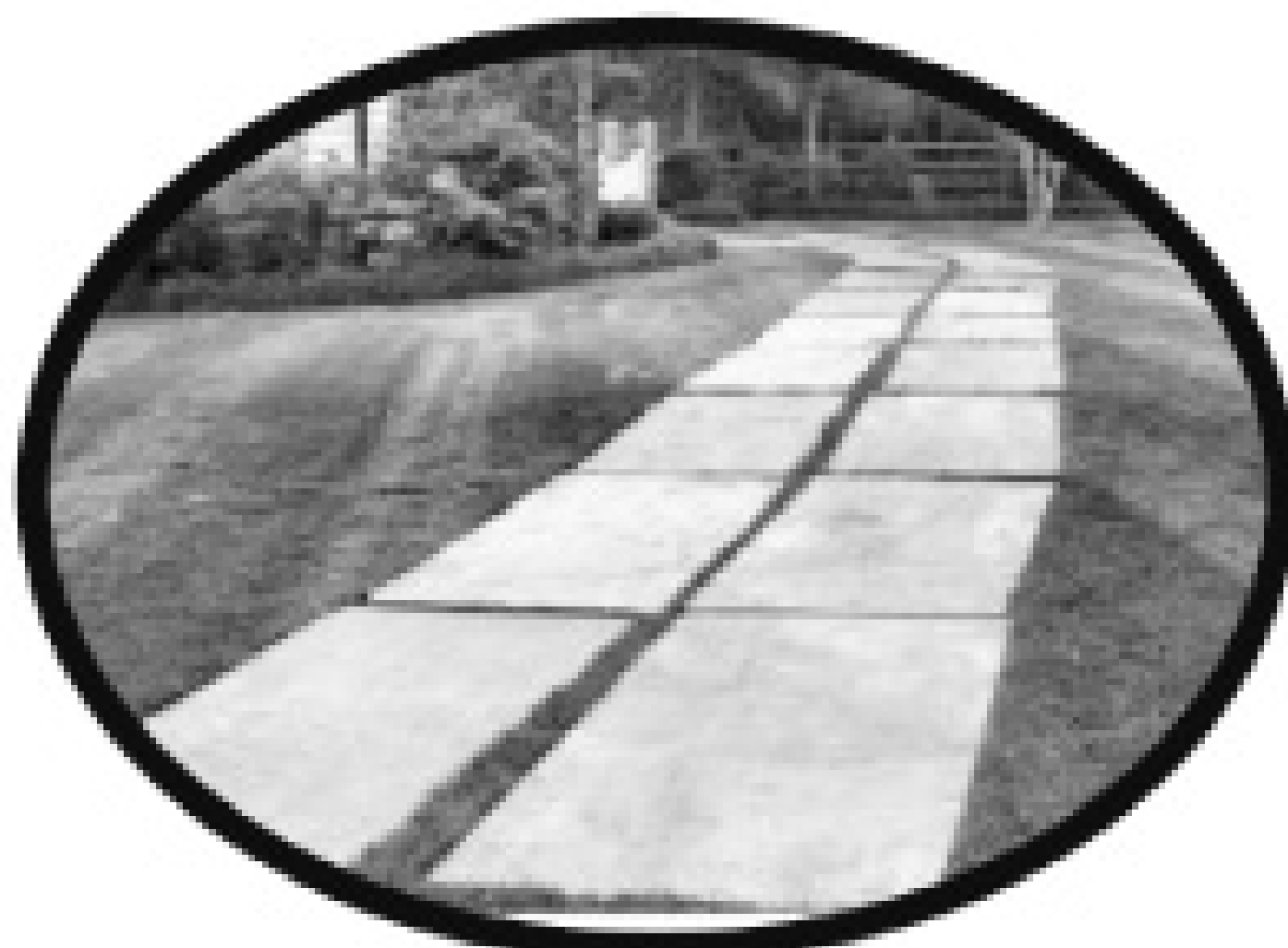

No more Ruts,
Damaged Lawns or Weather
Delays.

No more Heavy, Wet, Rotten,
Broken, Slippery Plywood

www.trakmats.com
sales@trakmats.com

Charlotte, NC 28216
Fax: 704.398.0540

800.762.8267

SVE Sales, Inc.

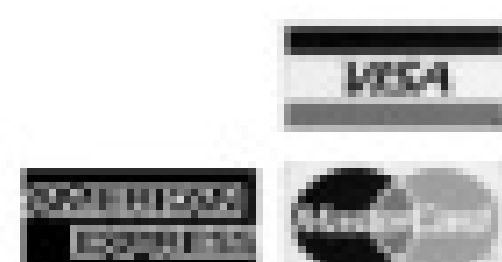

Inspections Made Easy! **V8**

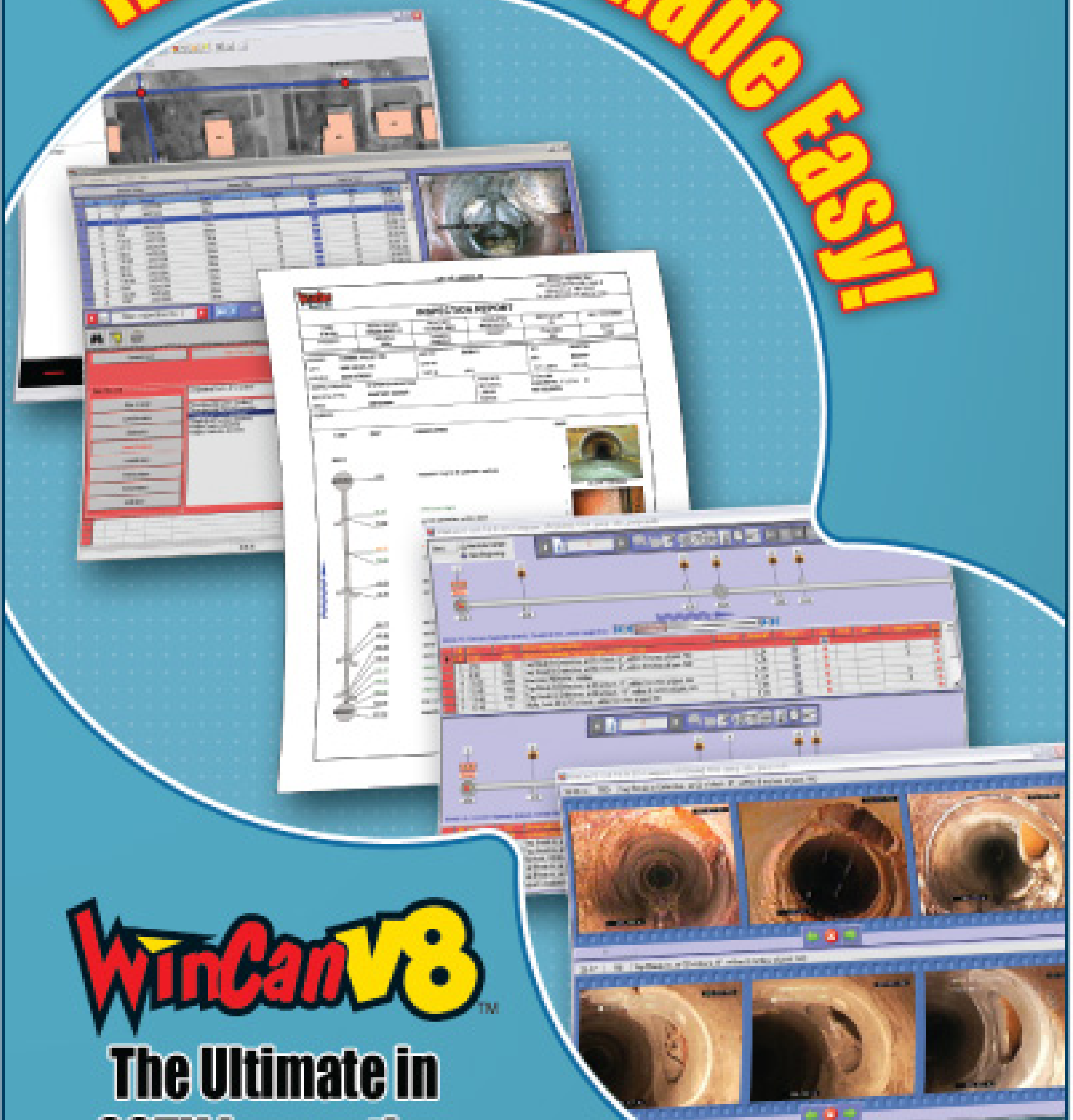

WinCan V8™

The Ultimate in
CCTV Inspection
Software

Essential information and tools are a mouse click away with WinCan V8's **Easy to Use Interface**.

WinCan **Works With Any Camera System** which allows you to use your existing equipment.

Quickly transform raw data into meaningful information with WinCan's **Flexible & Customizable Reports**.

WinCan combines all the tools you need to achieve and sustain **Compliance with Standard Code Systems**.

With inspection and distance tracking, **Compare Multiple Inspection Reports in Real-Time**.



505.341.0109

www.wincanamerica.com

Look for your WinCan America Authorized Dealer!

© 2008 WinCan America and WinCan America. All rights reserved. WinCan and the WinCan Logo are trademarks of WinCan America.

Environmentally conscious.
Technologically advanced.

FOCUSED ON THE WORLD'S UNDERGROUND INFRASTRUCTURE



Thanks for visiting us at the Expo!

Aries CoolVision Laser Profiler

The CoolVision Laser profilometry is a non contact inspection method used to determine underground piping profiles. The profiler uses an extremely accurate optical triangulation to gather highly precise dimensional results and measurements to accurately give the ovality or liner thickness of any pipe up to 48" diameter. Accuracy of the measurements is .25% of the diameter. The

CoolVision system is easily adapted to any new or existing Aries mainline inspection system.



Zoom Pole Camera

Aries high resolution camera module used in conjunction with the 432:1 zoom ratio and High intensity detachable LED lighthead, allows you see details that other cameras miss. The wireless operation makes the system extremely versatile and allows you to take it anywhere and transmit the video anywhere. When this system is used with the optional media case with 10" day light readable screen, it allows the user to inspect any pipe anywhere you can get to. For more versatility virtually any reporting software can be added to greater enhance the systems capabilities.



Pathfinder

When size and performance matters, Aries Pathfinder is the best 6" televising inspection system available! The Pathfinder is designed and manufactured in the U.S.A. by Aries Industries, Inc. The high resolution camera module and high intensity LED lighting let you see details that other cameras miss. The brushless drive motors and electronic clutches in the tractor yield longer life, less maintenance and maximum power in a minimum size for optimal productivity. The standard back-up camera with LED lighting helps negotiate bends in the pipe while retrieving system. The Pathfinder is designed and built with the Aries performance and durability that you deserve and have come to expect.

Proudly Manufactured in the U.S.A.

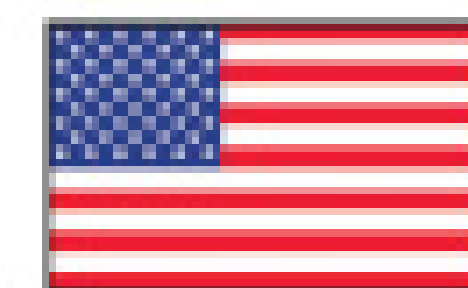

**Wisconsin – 1-800-234-7205 • California – 1-888-285-0366
Florida – 1-800-327-4346 • Mississauga ONT – 1-877-730-7010**

ARIES®

www.ariesindustries.com • Email: sales@ariesindustries.com

VT Vision Technology





INTRUDER™
Video Inspection System



MINI INTRUDER™
Video Inspection System



INTRUDER™ 4000
Precision Locator Locates Both
512HZ and 874HZ



VT-2000™
Professional Leak Detection System



VT-1000™
Professional Leak Detection System



DVD Recorder



INTRUDER™ ELITE
Video Inspection System



**24 Hour
Leak Expert
Hot Line**

- **Extended Warranties Available**
- **Now Serving All Of Europe**
- **Local Service Centers Throughout The US & Canada**
- **Flexible Lease Terms Available**

**For Your Local Representative Call
877-754-3435**

2548 South Paulson Rd., Suite B • Turlock, CA 95380
 fax: (209) 668-5847 • email: info@vtdesign.com
 phone: (877) 754-3435 or (209) 668-5840
 web: www.vtdesign.com

Introducing Lindhorst Nozzles



State of the art conical ceramic inserts

The All Star Kit is a complete self contained case featuring all the best nozzles available in each class. Arm your operators with a complete arsenal to deal with any potential line condition.



				
LHD-30.16 Chisel Point Use: Blockages of all types Features: <ul style="list-style-type: none"> • 8 Rear Jets for maximum thrust to ram blockages • 4 forward jets to clear stubborn blockages • Aggressive chisel shape & tool steel blasts through obstructions 	LHD-10.16 Rotating Nozzle Use: Cleaning crows, general cleanup of newer installations Features: <ul style="list-style-type: none"> • High speed spinning barrel scours, scrubs effectively • Excellent clean up of newer lines plus PVC • Right angled cleaning jets direct maximum force to the pipe wall to tear away grime 	LHD-40.16 Radial Nozzle Use: Every day workhorse Features: <ul style="list-style-type: none"> • 8 rearward dual angled jets for optimal coverage & cleaning power on the pipe wall • Optional forward jet allows for forward cleaning (shipped plugged) 	LHD-20.16 Grenade Use: Main Line Cleaning especially larger lines Features: <ul style="list-style-type: none"> • 10 rearward dual angle jets maximize cleaning & minimize streaking • Massive 3"x6" size for stability in larger lines • Aggressive jet design creates exceptional vortex vacuum action for maximum finish cleaning 	LHD-60.16 Torpedo Use: Long pulls and hills Features: <ul style="list-style-type: none"> • Aluminum lightweight body maximizes velocity • Used for difficult long runs & hills, this is the ultimate pulling nozzle • Low cost hardened steel insert design

Introducing The Best In German Engineering And American Design



LINDHORST
WORKHORSE NOZZLES

Conical ceramic inserts hold their dimension longer, directing maximum energy at the wall of the pipe. Debris explodes on contact. The finest German tool steel and high quality finish, maximize your horsepower!

702.324.2244
www.Lindhorstnozzles.com

Dealer inquiries invited.



Liberty Financial

GROUP, INC.

For
**Commercial Equipment
Lease Financing,**

call

888-883-4480

Ask for Michael DeGroat



Avoid costly utility strikes

Dig more safely with Vactor HXX vacuum excavators

Conventional excavation techniques can result in striking and damaging fiber optics, water lines, electrical lines, cable and gas lines. With a Vactor HXX vacuum excavator, you can excavate all around existing utilities—with minimal risk of damage.

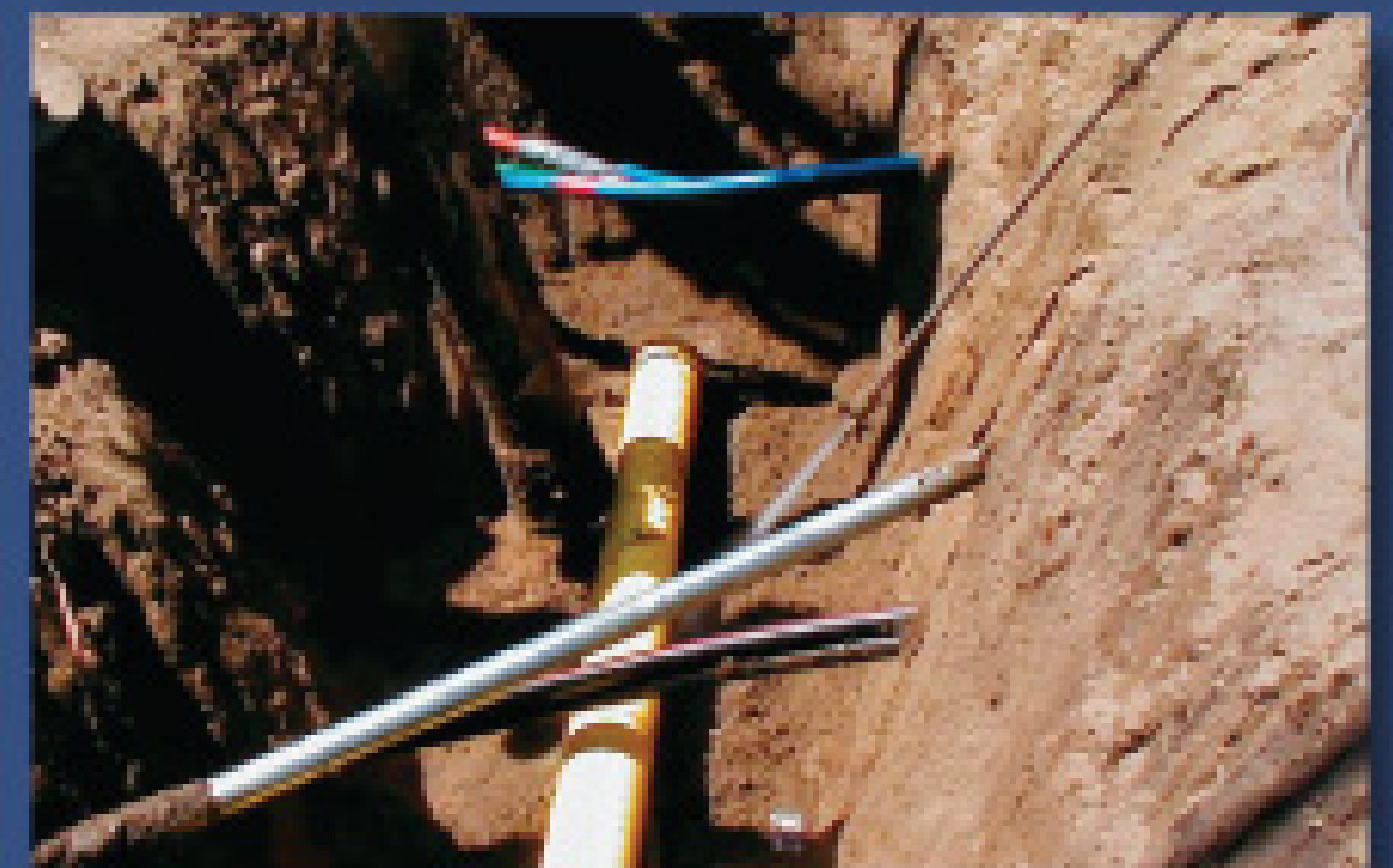

HXX Prodigy Mid-sized Vacuum Excavator

Excavates with water or optional air
Perfect for potholing or locating



HXX Full-sized HydroExcavator

Breaks soil apart with pressurized water
Excellent for big digs and deep trenching

To schedule a demonstration of the HXX HydroExcavator or the new HXX Prodigy, call Vactor at 1-800-627-3171 or visit www.vactor.com.

VACTOR®
HXX
VACUUM EXCAVATORS
Safe. Smart. Reliable.

lansas® PRODUCTS

MANUFACTURED BY VANDERLANS AND SONS, INC.



Custom Designs Are Always Available

High & Low Pressure Joint Tester



Vacuum Test Plate with Protective Cover



"Smart Box" Line Acceptance Test Kit



High Pressure Plugs ~ to 150 PSI

AR® Plugs



Multi-Size Domebeads Front and Back Plugs



Vacuum Pump Manhole Vacuum Testing



"Super Vac" Manhole Vacuum Testing

VANDERLANS AND SONS, INC.
 California 1-800-452-4902
 Atlanta 1-770-509-9309
 Minneapolis 1-763-428-9290
www.lansas.com



Central Winnelson

SeeSnakes™

Call us for Our Lowest Price!



LCD - DVD MONITOR AVAILABLE

SeeSnakes and Locators Ship Free!

6% one year financing available. Longer lease rates also available. Call Keith for details.

Buying a SeeSnake?

CALL US FOR GREAT PRICING AND FREE SHIPPING!



**- Call Us Evenings and Weekends -
 Keith: 405-602-9155 & Jim: 405-205-3974**

AUTHORIZED RIDGID SEESNAKE REPAIR CENTER

Ridgid SeekTech®

Locating Made Easy

Price Too Low to Advertise!

CALL FOR SPECIAL RIDGID PROMOTIONS

5037 NW 10th • Oklahoma City, OK 73127
www.centralwinnelson.com

Toll Free: 888.947.8761

Changing the way you **work**



Fuel Prices are Soaring...

Chassis Prices are up 30% from last year...

That New Combination Sewer Cleaner Truck you are looking at is now \$300,000...

Get more out of that chassis with the Ramvac 3600 hook/lift combination sewer cleaner. We give you the performance you need and your chassis back when you aren't cleaning sewers.

Let us Change the Way You Work!



www.sewerequipment.com

www.mongoosejettters.com

www.ram-vac.com

OLDEST NAME IN THE BUSINESS

— Over 100 YEARS OLD —

**Call for the lowest prices on General Machines...
...I'd give them away, but my wife won't let me, SHE'S CRAZY!**



**CALL FOR
GENERAL
SPECIALS**

Special pricing on all General jetters, cameras and machines



Repair Center for:

**Ridgid SeeSnake, Gen-Eye,
Radiodetection, Vision Technology
& Spartan Cameras**

Fast Turnaround Time

Root Rat *root cutter nozzle*

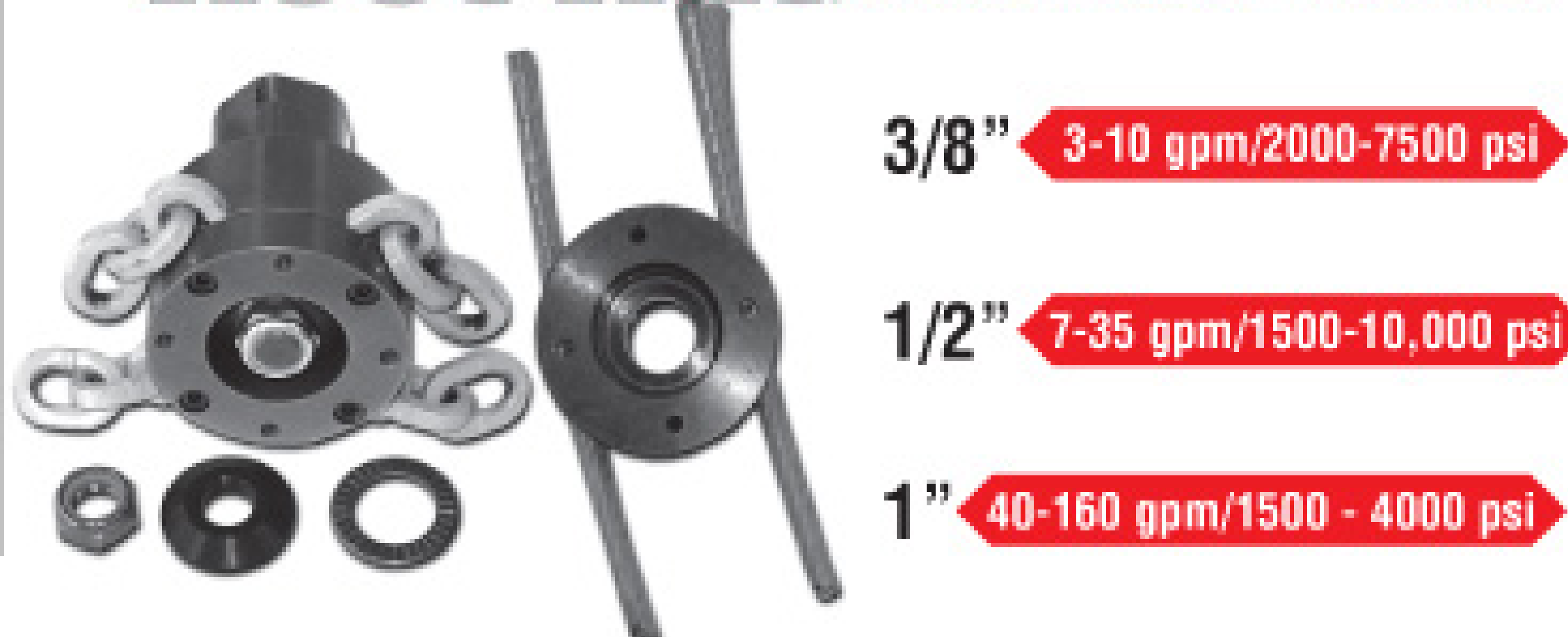

Allan J. Coleman Co., Since 1905 - Call us today! 773-728-2400

"THESE PRODUCTS ARE SO GOOD, WE GIVE YOU OUR ADDRESS!"

5725 North Ravenswood Avenue • Chicago, IL 60660 • www.allanjcoleman.com

PHCC MEMBER

Check Out What's New From the
Industry Innovator for Over 75 Years

**SRECO
FLEXIBLE**

The Bronco Trailer Jet

Kicking Out Even More Productivity

THE BRONCO:

A powerful trailer-mounted jet system featuring high water pressure and GPM delivery at a budget friendly price.

CLEAN & VIEW:

System includes an integrated JetCam video camera with an LCD monitor and built-in DVR for documenting your work.

ERGONOMICALLY DESIGNED:

Built with productivity in mind, the Bronco features a smooth, articulating reel and centralized, easy-to-operate control panel.



- ✓ 20 gpm at 4000 psi
- ✓ 325 gallon water tank
- ✓ Up to 600' of hose capacity

SRECO Flexible, one of the most highly recognized names in the manufacturing of sewer cleaning products for the wastewater collection systems industry, is pleased to present the Bronco, a compact "workhorse" trailer jet for efficiently handling your toughest pipe cleaning projects.

Feature rich and budget friendly, it is ideally suited for the busy contractor and small municipalities alike.

The Bronco can be equipped with a variety of sewer cleaning tools and nozzles for optimum cleaning versatility.

SRECO Flexible...Seventy-Five and More Than Alive!



**Visit Us Online At:
www.srecoflexible.com**

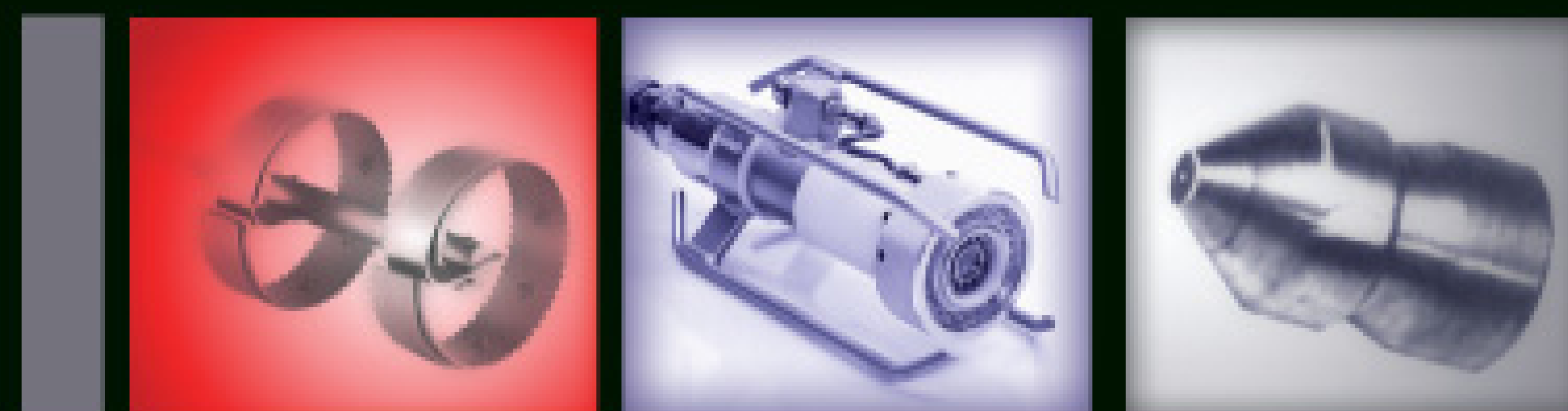

the right tools for the job

Toll Free: 800.421.6536
310.606.9009 local
info@srecoflexible.com

Pipeline Inspection Technology

NEW
DIGITAL CONTROL
MODULE!

flexiprobe push rod video inspection systems

Pearpoint inspection systems, featuring the **NEW P330+ flexiprobe control module**, bring you all the benefits of advanced digital technology and easy keypad operation, putting you in complete control.

P330+ flexiprobe system

Ultra-bright 8" (200mm) TFT screen

Quick transfer of video and still pictures via USB and Bluetooth® wireless technology

Durable keypad for easy access to all key functions

Splashproof keyboard for text entry



Waterproof stainless steel/sapphire camera with maintenance-free LED lighting

Easily transportable compact reel

Each system comes complete with a universal easy-fit brush skid set that allows the 1" camera to be used in pipes from 25mm (1") up to 100mm (4") diameter and the 2" camera to be used in pipes from 50mm (2") up to 150mm (6") diameter. Brushes can be conveniently replaced in seconds.

The Bluetooth word mark and logos are owned by the Bluetooth SIG, Inc. and any use of such marks by Radiodetection Ltd is under licence.

To find out more call us Toll Free (800)-688-8094 ext 245 or visit www.radiodetection.com



Pearpoint 72055 Corporate Way, Thousand Palms, CA 92276, USA

©2008 Pearpoint, Inc. / Radiodetection Ltd. All rights reserved. The Logo and "flexiprobe" are trademarks owned by Radiodetection Ltd. Due to a policy of continued product development, we reserve the right to alter or amend any published specification without notice. Radiodetection Ltd. is a subsidiary of SPX Corporation

flushquip inc. 1.800.295.1669

We have solutions for your sewer cleaning problems

Please call, fax or email your request for a complete catalogue

Fax: 1.204.697.4790

Email: ubaziuk@mts.net

1900 Brookside Blvd.
Winnipeg, Manitoba
R3C 2E6

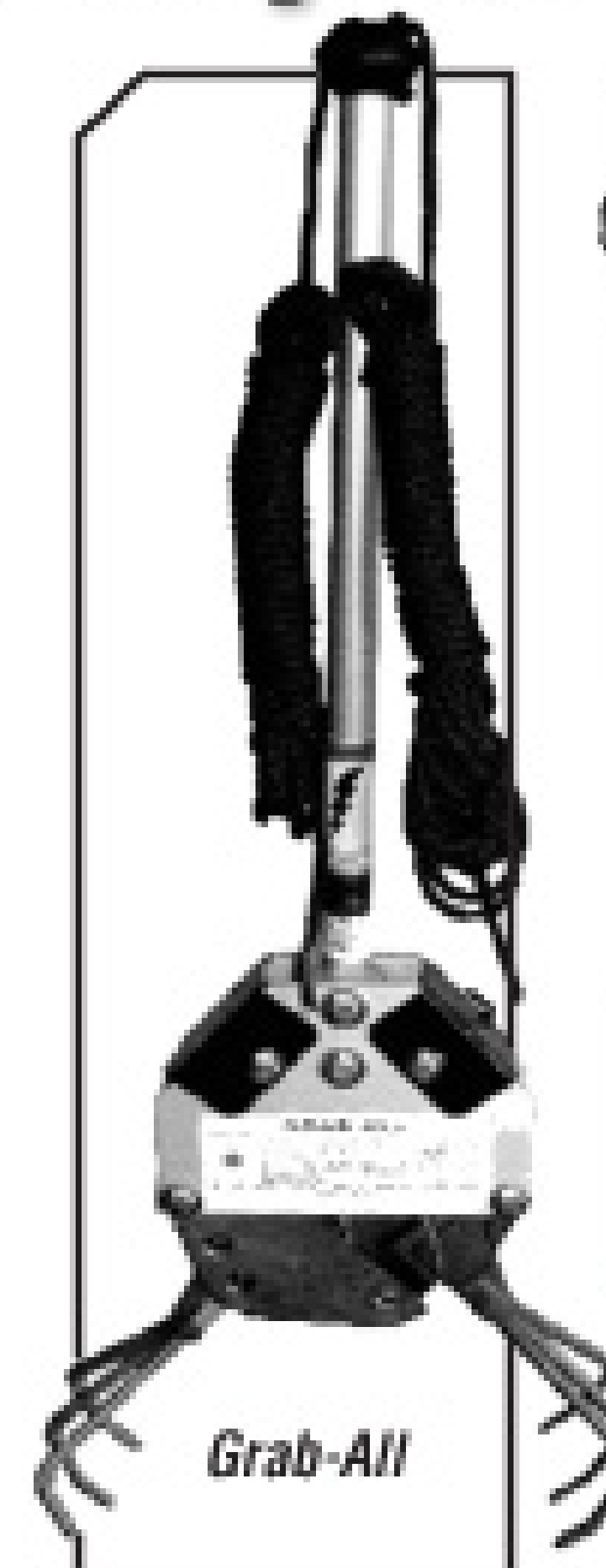

Grab-All



Rocket Nozzle



Penetrator Nozzle



Finned Fantail



Torch Nozzle

Also check out our website:

www.flushquip.com

\$ We've Got the Money \$

For All Your New and Used Equipment Needs

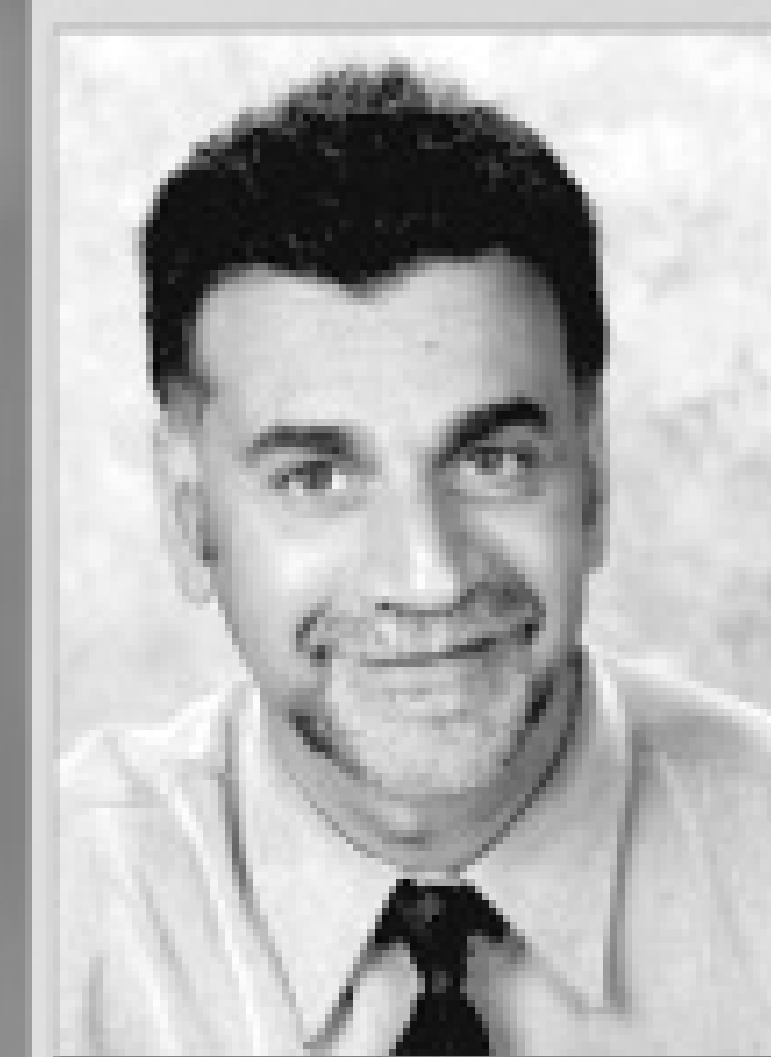

Chuck Territo



Mike Rausch

- \$250k Application Only
- Simple Approval Process
- Lease or Loan Options
- New & Used Equipment
- Flexible Finance Options
- Start Up Programs

Let us put our 35 years of experience to work for you! Call today and see why...

It pays to lease with us!



Thanks for visiting us

Granite Leasing Co.

800.246.7997

www.graniteleasing.com

Opening Day has passed us by, but hunting season is far from over!



So you didn't bag your truck in Louisville...Jack Doheny Supplies can still help you land that trophy piece of equipment. To keep the hunt alive, simply log onto:

www.dohenysupplies.com

Jack Doheny
Supplies 

*"World's Largest Distributor of Sewer Cleaning,
Air Handling and Street Sweeping Equipment"*

Call Jack Doheny Supplies
to schedule your hunt

800-336-4369

www.dohenysupplies.com

enz golden jet®

The Leader in Cleaning Performance & Dependability

Rotating Nozzles with Speed Control
Chain Flail Heads for Root Cutting
Impact Drilling Cutter Heads for Cutting Concrete
Vibrating Rotojets

Enz golden jet is the leader in sewer and pipeline cleaning equipment, offering a versatile, durable and economical line of virtually maintenance-free products, which outperform the competition time and again.



Sizes: 1/8" NPT-1-1/2" NPT
Volume: 3-150 GPM
Pressure: 1000-14,000 PSI

ENZ USA INC

1585 Beverly Ct., Unit 115 • Aurora, IL 60502
Call 877-ENZUSA1 (369-8721) for a Dealer Near You
www.enz.com

Call 630-692-7880 today to learn how easily
Enz Golden Jet Nozzles can fit into your existing operation.

WE'VE GOT DRESSER ROOTS BLOWERS ... AND A LOT MORE

The Dresser Roots blowers are the finest truck mounted units available today. And, as a factory authorized sales and service center we're here to provide the best support for all your blower applications.

We're also here to help with your vacuum equipment repairs, rebuilding, and replacements that also includes our special blower exchange program.

Just give us a call.

DRESSER Roots

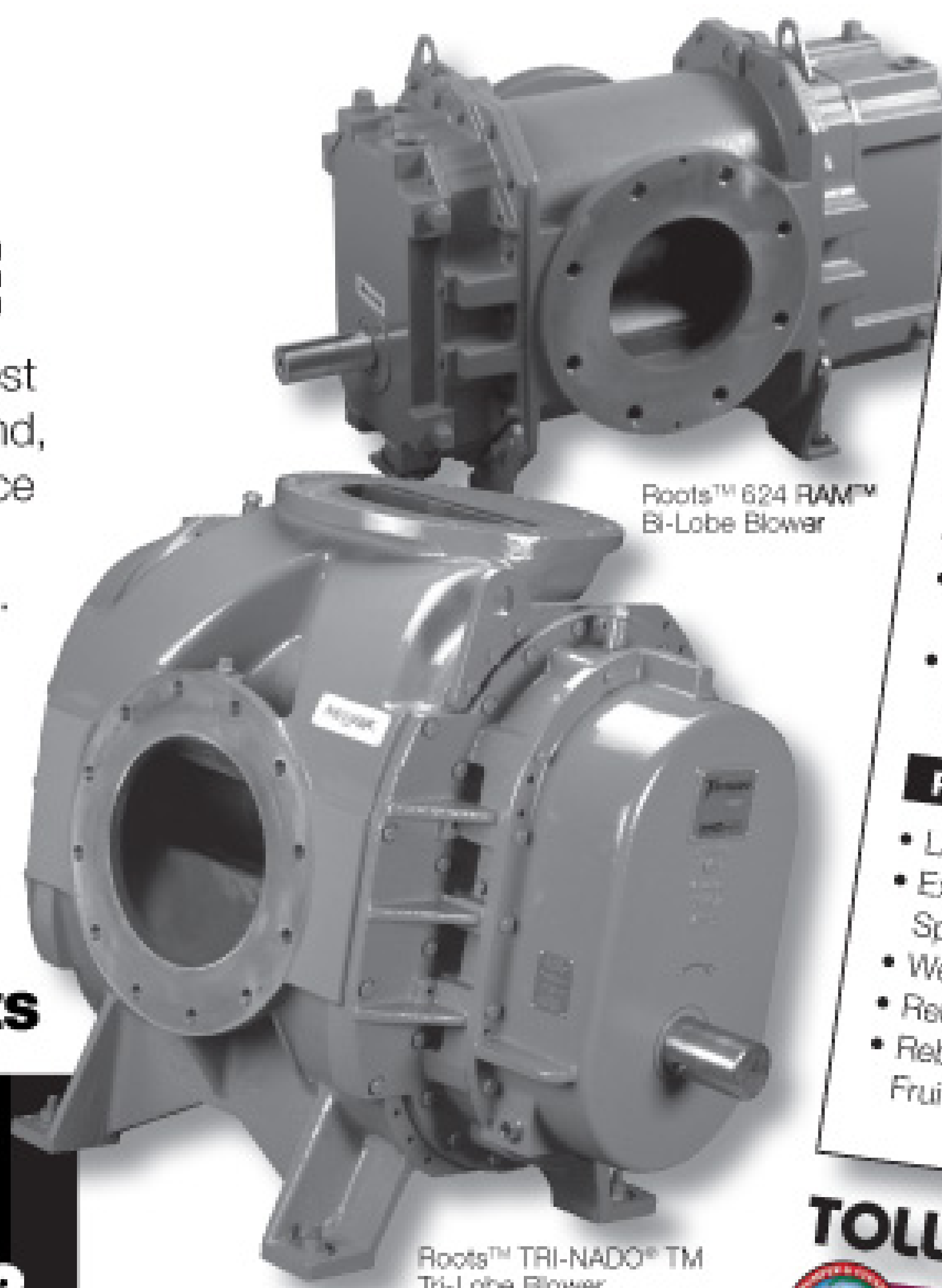

VACUUM PUMPS, TRUCKS & ACCESSORIES

- Aquatech** • Sewer trucks & equipment
- Conde** • Toilet truck vacuum pumps
- Hi Vac** • Industrial vacuum systems
- Metaltecnica** • Valves & accessories
- O'Brien** • Sewer cleaning jettors
- Presvac** • Septic & sewer trucks
- Roots** • Bi-lobe & tri-lobe vacuum blowers
- Stoddard** • Intake filters & discharge silencers
- World-Tech** • Sewer cleaning nozzles & valves

COMPLETE FABRICATION & MACHINE SHOP

- 24 Hour service
- Custom built blower and pump vacuum/pressure packages: electric, gas, or diesel
- Custom parts fabricated or reconditioned including bearings, shafts & sleeves

REBUILD SPECIALISTS

- Largest blower repair center in the Universe.
- Experts in rebuilding blowers: Roots, Sutorbilt, Spencer, and Hibon
- We rebuild all vacuum pump makes and models
- Rehab sewer cleaning trucks and equipment
- Rebuild kits in stock for Schult, Wittig, Moro, Jurap, Fruitland, and Challenger

TOLL FREE: (800) 359-PUMP



Orlando, FL: 800-359-7867 • WWW.PATSPUMP.COM • Atlanta, GA: 800-851-7987

©2008, RIDGID, Inc.
The Emerson logo is a trademark and service mark of Emerson Electric Co.

THE TECHNOLOGY YOU NEED. THE TOUGHNESS YOU DEMAND.

The new RIDGID® SeeSnake® LCD Monitor + DVD features a high-resolution color picture and DVD recording. At a weight of only 25 lbs., it is 40% lighter than other models. One-touch recording makes it the easiest to use DVD system on the market. Designed to be durable, it works where you work, like you work. It is our most advanced inspection system ever.

Learn more and schedule demonstrations: 800.769.7743 or www.RIDGID.com.

*"We tried it and we fell in love with it."
Tom Mitchell Personal Plumbers*



We Build Reputations™

RIDGID®

EMERSON
Professional Tools

DIAGNOSTICS

PRESSING

PIPE & TUBE TOOLS

DRAIN MAINTENANCE

POWER TOOLS

Bringing Leaks to Light

Smoke and dye testing give contractors simple yet effective tools to help communities and commercial customers find system defects

By Scottie Dayton

Contractors are often called upon to locate leaks and sources of inflow in sanitary sewers, or to identify faults in mains, laterals, and house plumbing, including roof and yard drains. They may be asked to find sources of odors, locate cross-connections, trace plumbing and power plant piping, and analyze onsite treatment systems.

Smoke and dye testing are simple, inexpensive, yet effective methods for conducting those kinds of investigations. Smoke-generating devices (SGD) using candles, bombs, and liquid agents help pinpoint leaks in sewer pipes. Fluorescent dyes make it easy to trace errant flows of water to the source. By knowing what to use, and how, and in which situations, contractors get the desired results as efficiently, quickly, and productively as possible.

Smoke-testing protocol

Contractors usually perform smoke testing on behalf of municipalities or sewer utilities. As part of the protocol, members of the public and fire and police departments must be notified before a test begins. The usual notification procedure is to distribute leaflets door to door, and sometimes use the news media to spread the word.

"Smoke may enter buildings through faulty plumbing, and if

smoke can enter, so can dangerous sewer gases," says Bob Rothenberg, vice president and general manager of PrimeLine Products Inc., a provider of smoke testing products. "Building owners are usually thankful that defects are discovered during testing, and not after someone falls ill from escaped gases."

Sections of pipe to be tested are usually plugged. Then a gasoline-driven blower pushes smoke through the lines with enough force to penetrate leaks. A negative test doesn't mean the results are conclusive. Sagging laterals can trap water, blocking and preventing the smoke from reaching roof leader connections or driveway drains. Debris collecting in stormwater basins or lodging in pipes also prohibits the passing of smoke.

Sometimes smoke is observed escaping from grassy areas or through cracks in the pavement, indicating damaged pipes or open joints. "Smoke testing should not be used to locate these defects, as high groundwater and tight soil conditions can trap smoke below ground," advises Rothenberg. "For these reasons, contractors should choose blowers with high airflow outputs."

Bombs and candles

Contractors can choose time-tested solid smoke-generating devices or the more recently developed liquid smoke. Both products have their place.

Scott Jensen, western region sales manager for Cheme Underground, notes that solid devices seem more intuitive — just light the fuse, place the product in the smoke blower, and begin testing. "Some contractors say that solids produce better-quality smoke, but someone has to light them," he says. "The work involved in maintaining a



Smoke testing is a simple and reliable method of locating leaks in sewer systems. (Artwork courtesy of Hurco Technologies Inc.)

"Smoke may enter buildings through faulty plumbing, and if smoke can enter, so can dangerous sewer gases. Building owners are usually thankful that defects are discovered during testing, and not after someone falls ill from escaped gases."

Bob Rothenberg
PrimeLine Products Inc.

continuous flow of smoke could mean additional labor."

Typical smoke bombs last three minutes, but 60- and 30-second varieties are available. One possible solution is to use double-wick devices that tie together, increasing the smoke-generating time. The products do have a shelf life and can be adversely affected by humidity.

Classic smoke candles generate a highly visible, uniform white smoke that travels farther and shows leaks that some systems may miss, says

James A. Kovacs, general manager of Superior Signal Company Inc. The candles, with a total obscuring power 10 times greater than crude oil, fit most blowers, including those designed for liquid smoke.

Fuse ignitions can be dangerous in the presence of volatile sewer gasses, and the National Institute for Occupational Safety and Health (NIOSH) requires workers to wear respirators in areas where smoke can be inhaled, notes Lyndon "Lynn" Hurley, president of Hurco

Tech Perspective looks at technology-related issues and provides information and advice that cleaning professionals can apply to equipment selection and to their daily work in the field. Industry members are welcome to offer ideas for this column. Please direct them to editor Ted J. Rulseh, editor@cleaner.com.



An Air-Loc smoke testing system from Cheme Industries Inc.

Technologies Inc. The smoke contains high concentrations of zinc chloride, which attacks the respiratory system. "Proper smoke-testing programs should include laboratory-tested products and trained two-man crews," he says.

Bottled smoke

Liquid agents also generate dense smoke. "They have a longer shelf life than SGDs and seem to be gaining in acceptance," says Jensen. "Because the product creates a continuous flow of smoke, crews spend less time monitoring the blowing equipment."

Liquid smoke, in one-gallon, five-gallon, or drum-size containers, is poured into a pressurized tank connected to the blowing machine. One disadvantage, according to Jensen, is that operators may initially need extra time dialing in the blower to generate the optimum smoke.

"Choosing one system over the other depends on the quality of smoke, economics, and the consulting engineer's specifications," says Kovacs. "Smoke fluid systems can be custom-engineered to produce the maximum dry smoke using insulated liquid smoke conversion chambers and precision injectors."

Liquid agents, because they do not require a fuse for ignition, appear safer. However, Hurley advises contractors to obtain independent laboratory tests on the smoke being generated, not on the liquid as covered in MSDS sheets. "That's the

"Yellow-green dye is more resistant to absorption by suspended material in the water and is significantly less resistant to photo degradation than red dye. Red dye stands out more clearly from normal background fluorescence and in the presence of green algae."

Tim Muldoon
Kingscote Chemicals Inc.

only way to determine which agents are safe," he says.

Air and smoke blowers from Superior Signal come in squirrel cage and propeller configurations with various air flows and static pressures. Cherne Industries, for example, makes a lightweight, cast-aluminum smoke blower that generates more than 3,700-cubic-feet-per-minute of air flow. A 1/2-inch, foam-cell gasket provides a leak-free seal on manholes and minimizes vibration. Contractors can use the blowers with the smoke bomb box holder or add a pressurized tank and hose to accommodate fluid smoke.

Fluorescent dyes

Fluorescent dyes act like a coloring label on each drop of water, tracing its travels until the dye reaches extreme dilution. The visual aspect of fluorescent dyes refers to normal reflected light as color. The fluorescent aspect refers to chemical properties that absorb certain wavelengths, then emit, rather than reflect, light.

Technicians can see fluorescent

emissions by using black (ultraviolet) light or precisely measure the emissions with fluorimeters. Reflected and emitted light have different wavelengths and are, therefore, not the same colors.

"Fluorescent properties are of greatest value when tracing where there is no sun, or where the artificial light source is insufficient, precise quantified data is required, or minute amounts of tracing material are allowed," says Tim Muldoon, vice president of Kingscote Chemicals Inc., and dye producer.

Blue dyes have the highest degree of light stability, and reds are recommended for yellow and green backgrounds such as algae-rich water. FWT red and blue and FLT yellow-green are for waters that bear heavy sediment loads or that pass through soil with high clay content.

The dyes, which are temporary and degrade in sunlight, come in tablets, liquids, powders, and wax forms such as cakes, cones, and doughnuts. "For small quantities of water, tablets are easy to use and require no measuring," says Muldoon. "Technicians can drop or flush them into the system, where they dissolve in three to five minutes. They also can be dissolved in water to form a calculated concentration."

Powders and liquid concentrates are better suited for larger bodies of water. In situations of long-term flow or ongoing coloration, wax products provide optimum dissolution rates in large systems. Doughnuts can be suspended from a string into water. Cakes and cones are used in medium and small systems.

Color wheel

Muldoon says deciding which dye color to use depends on the color, type, water turbidity, and the suspended solids in it. "Any color dye works in clear water," he says. "If the liquid is yellow or green, FWT red (rhodamine WT) is best,

especially if using visual methods to estimate dye concentration. Visually, the dye appears bright pink to red, depending on its concentration, and bright orange under ultraviolet light."

Muldoon recommends FLT yellow-green (fluorescein) for murky brown water. It appears yellow-green visually or lime-green under UV light. "Yellow-green dye is more resistant to absorption by suspended material in the water and is significantly less resistant to photo degradation than red dye," he says. "Red dye stands out more clearly from



Smoke candles like these from Superior Signal Co. Inc., create a uniform and highly visible white smoke.

normal background fluorescence and in the presence of green algae." The absorption-emission wavelengths also are different.

Blue dyes are only visually detected, appearing aqua to royal blue, depending on the concentration and the activity of the water. Blue has the highest light stability, while red is recommended for yellow and green backgrounds, such as algae-rich water.

The dyes are nontoxic, biodegradable, and certified to meet ANSI/NSF Standard 60 for use in and around drinking water. However, technicians should wear gloves and goggles, as dyes may cause skin irritation and staining.

Simple, low-cost testing programs save taxpayers money and reduce unnecessary maintenance chores, while sustaining the public's health and the environment. ■



Smoke testing requires little more than a smoke-generating device, a blower, and a knowledgeable crew. (Photo courtesy of Cherne Industries Inc.)

YOUR RIG + OUR TOOLS

the equation for optimum sewer cleaning performance.

**Nozzles . Saws & Cutters . Hoses & Swage Tools
Sewer Cleaning Machines . Pumps and More...**

For over 25 years Shamrock Pipe Tools has been helping municipal sewer service contractors achieve unparalleled results with high precision tools for every type of pipe cleaning project.

Shamrock's excellence in design, materials and manufacturing processes provides our customers with increased efficiency and productivity, outstanding tool performance and reliability, along with an excellent return on investment.

Call or visit us online for more info on our complete range of pipe cleaning tools and accessories.

**SHAMROCK
PIPE TOOLS, INC.®**

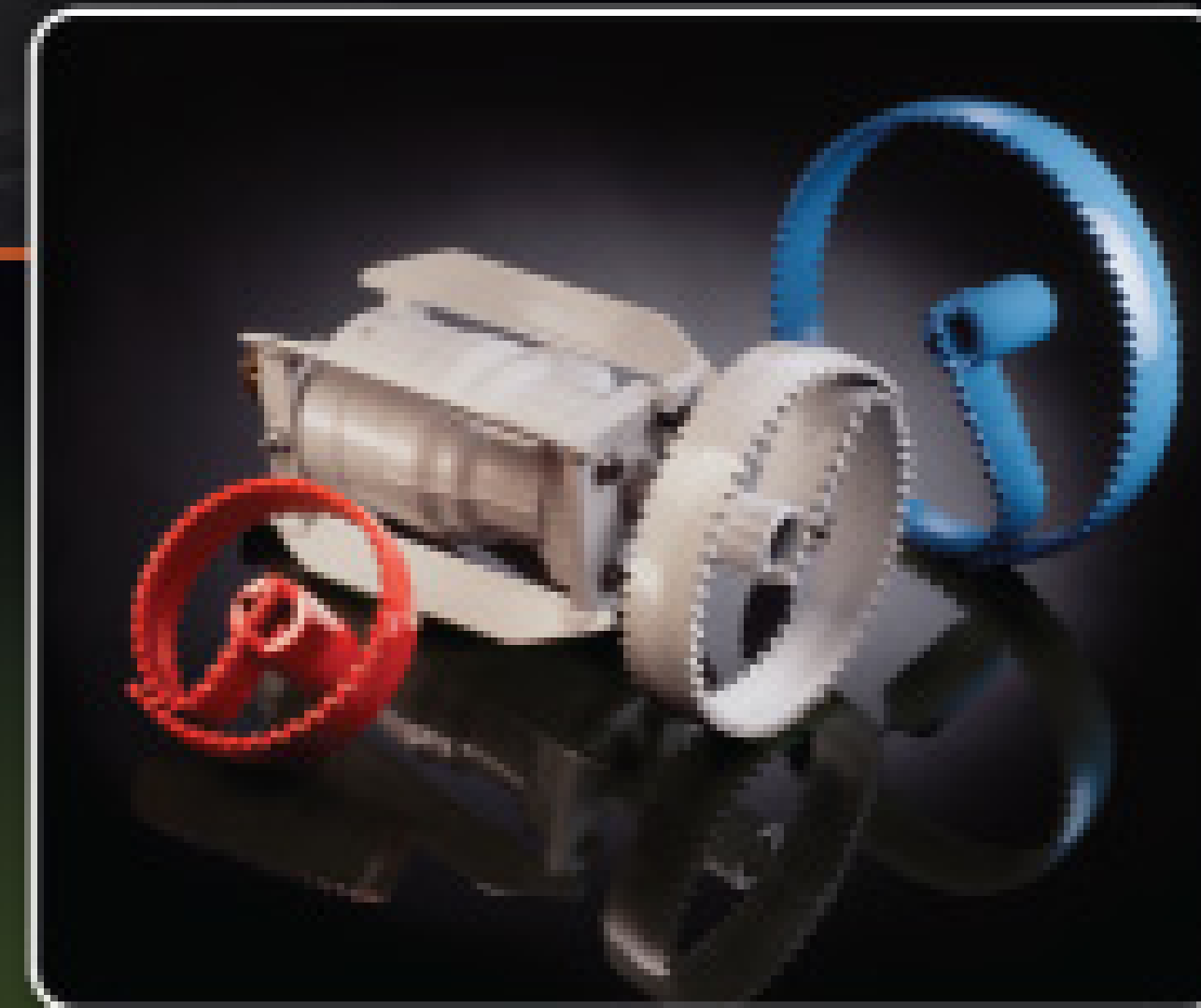

EXCELLENCE IS REFLECTED IN EVERYTHING WE MAKE." ... 800.633.7696 ... WWW.SHAMROCKTOOLS.COM



3 NEW vCam Digital Systems



- Digital Command Module with MP4 recording (60GB hard drive)
- Crystal Clear 8" TFT LCD display
- Three reel types, all work with Digital Command Module
 - Mini reel "M" Type
 - Standard reel "C" Type
 - Large reel "P" Type
- USB interface to transfer video
- Full function keyboard and titler
- ABS injection molded housing
- Powered by internal rechargeable batteries, mains or 12v dc (car power)
- Color Self Leveling Cameras

Vivax Corp
23-27 Bland Street
Emerson, NJ 07630
TEL 201 265-5502

www.vivax.biz

ALL THE TOOLS OF THE TRADE. FROM ONE SOURCE.

ANIMATECH

COMBINATION MACHINES ENGINEERED & BUILT AROUND THE OPERATOR.



O'BRIEN®

JETTERS THAT PAY FOR THEMSELVES. AGAIN, AND AGAIN, AND AGAIN.



ultraVac®

THE NEW POWER IN HIGH VACUUM LOADERS.



X-vac®

VACUUM EXCAVATORS. THINK OF THEM AS SURGICAL INSTRUMENTS.



When you invest in any of the Hi-Vac Corporation Brands, you are getting "The most value for your money". They are designed to be the easiest to operate. Cost less to maintain. And, are built tough to withstand the test of time.

Hi-Vac®

HI-VAC® CORPORATION

740-374-2306
USA 800-752-2400
FAX: 740-374-5447
hi-vac.com

Dyna-Vac Equipment

Jet-N-Vac

The Power, Performance and Reliability you need for Demanding Pumping and Sewer Cleaning Service

NEW

SS Drive System

The most cost effective, safe and efficient drive system available for trailer mounted combination sewer cleaners

Patent Pending



Select our standard units or let us custom design a machine to meet your specific needs. No matter what your pumping we can make the task easier and more productive with the ideal piece of equipment



Dyna-Jet

Sewer Jetting Equipment

Simple Designs, Tough Durable Construction and Unquestionable Power make **Dyna-Jet** Sewer Jetting Systems a practical choice. Systems from 5-40 GPM Skid or Trailer mounted

Dyna-Jet 20-4000 in Stock

888-298-8668 Built in Central New York

www.dynavacequipment.com

315-865-8084

YOU CAN INSTALL SEWER and WATER LINES

(WITHOUT DIGGING A TRENCH!)

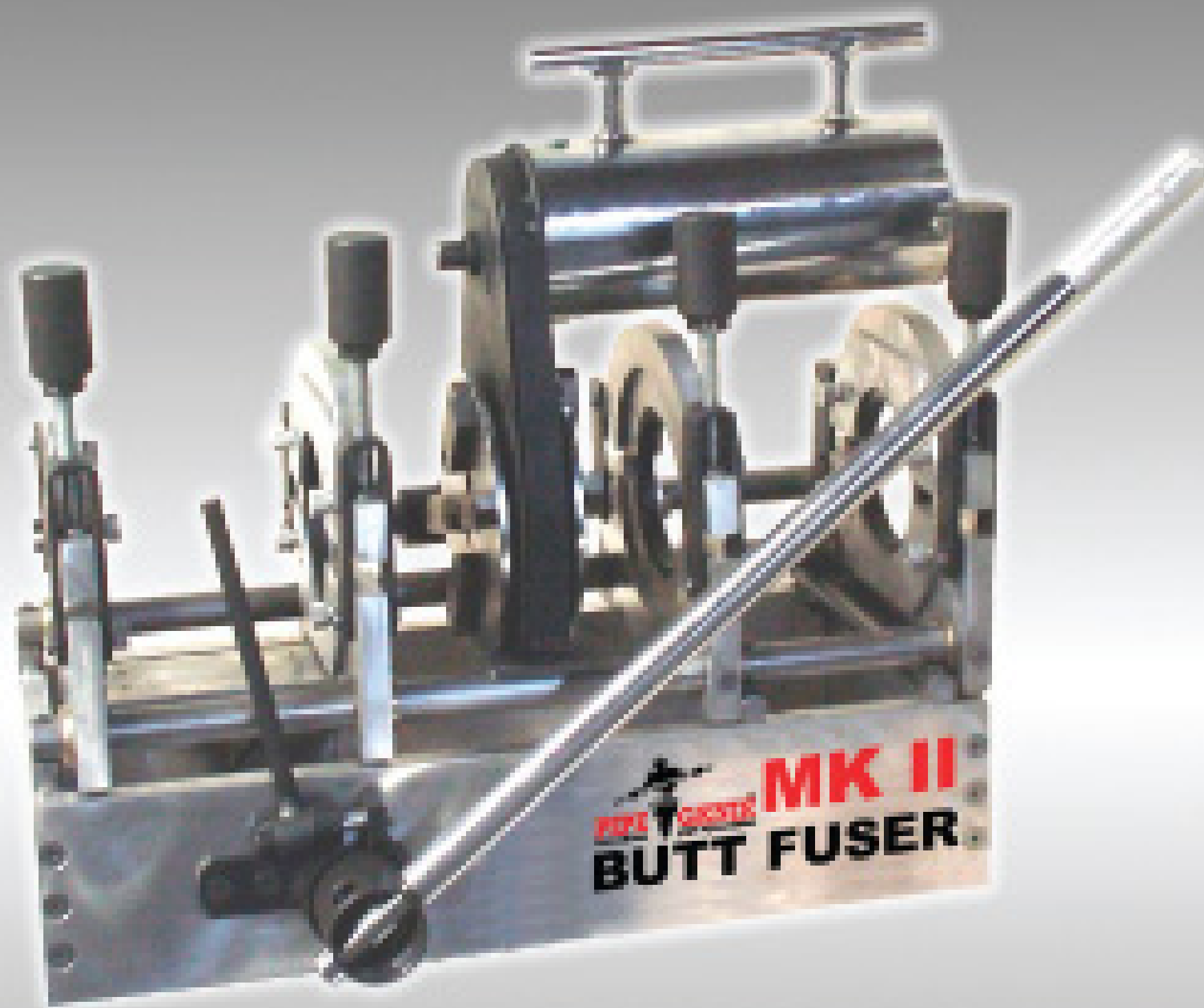

HOT BEAD FUSING 2-8"

Save time with inline fusing as you continuously pull PE pipe!

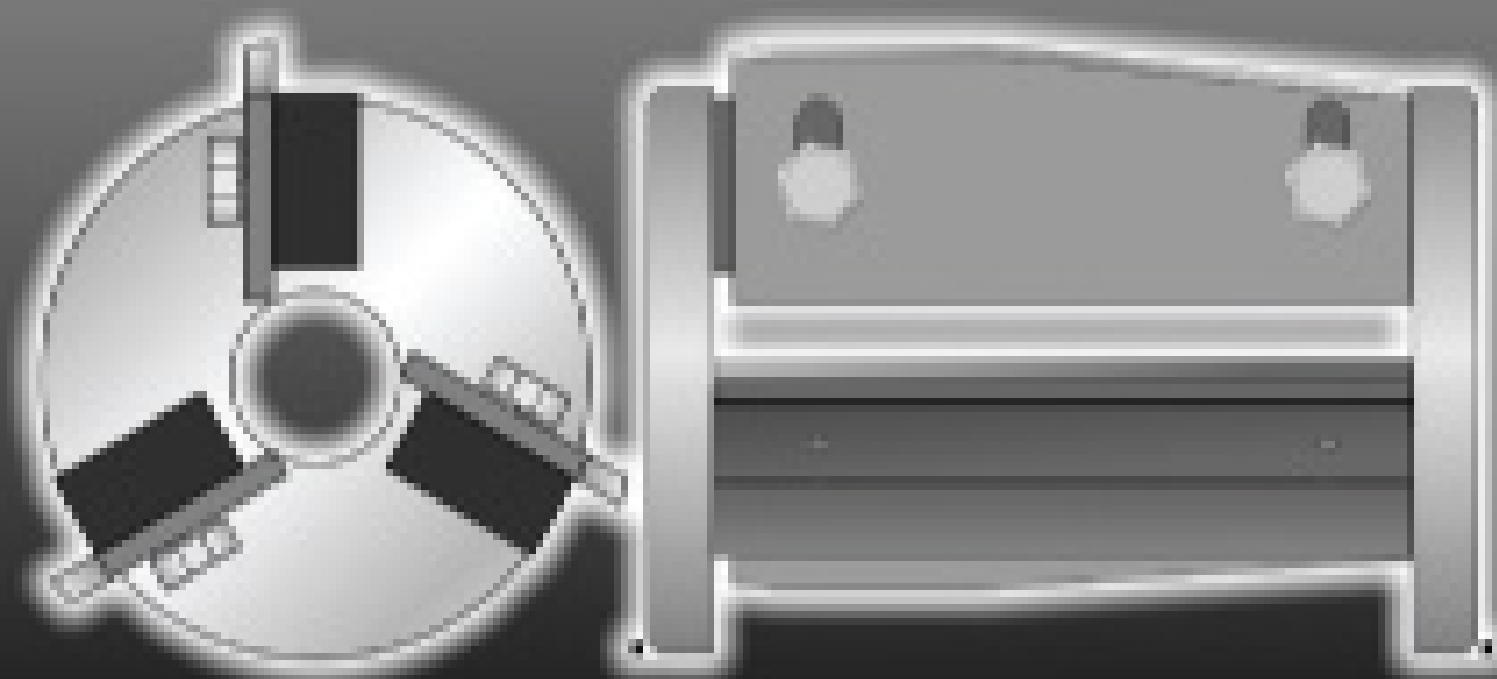

Ream Inner Beads 3 - 16"

Models to accommodate pipe diameters ranging from 4 inches to 20 inches! (24 and 40 foot kits available.)

Pipe Genies Do It All!!

Ductile & Cast Iron, Clay & Concrete, ABS, PE & PVC

Pipe Genies Pull Any Pipe!!

System Power From 20 Tons to 240 Tons!
(Rated for 1/2" - 30" pipe)

Pipe Genies Work Anywhere!!

The Most Compact Systems Available!

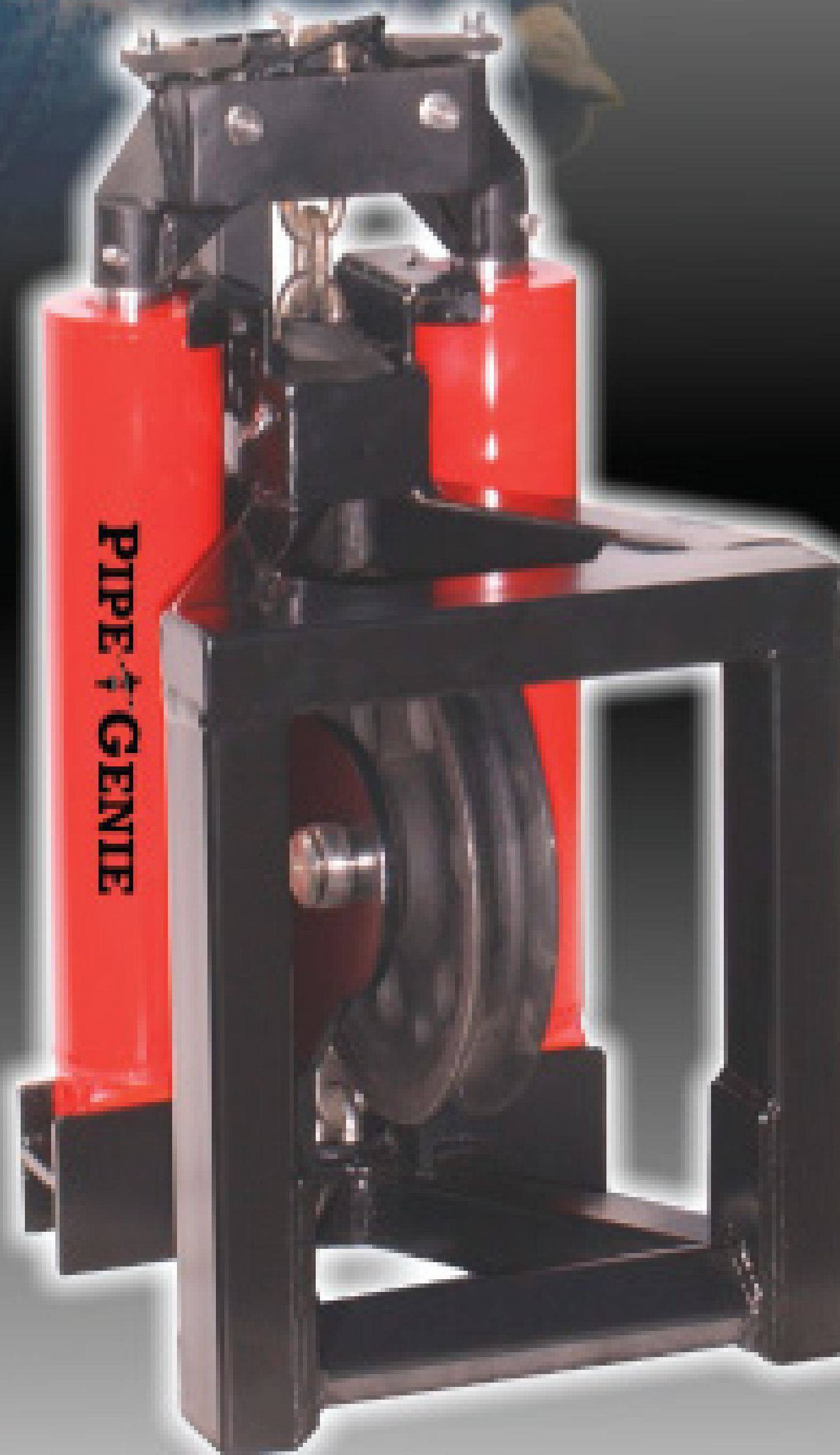

PIPE BURST 1/2 - 30" PIPE

**Videos
Now Online!**

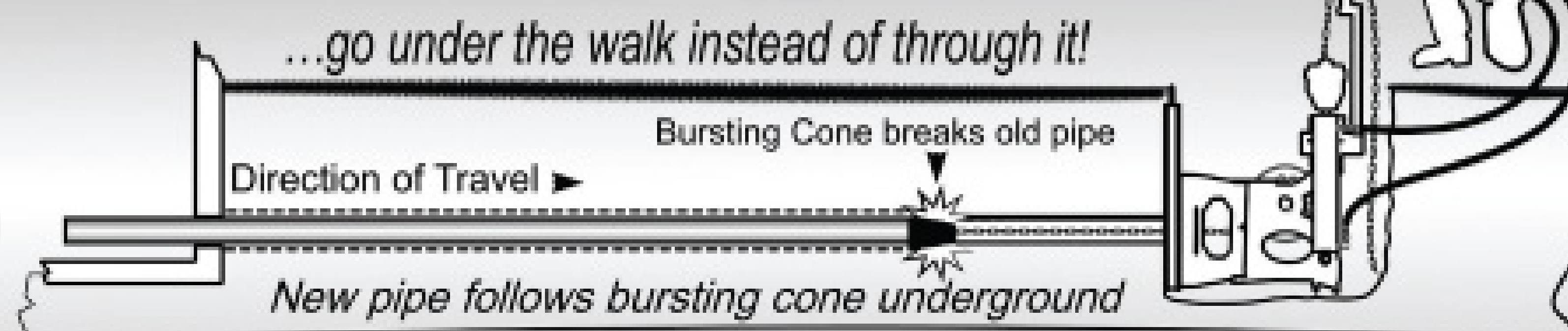

We have everything you need to get started making profits with pipe bursting!



Slice Old Water Pipe

Easily handle those 1" copper pipes with brass fittings, and tricky 1"+ schedule 80 steel gas line pipes!

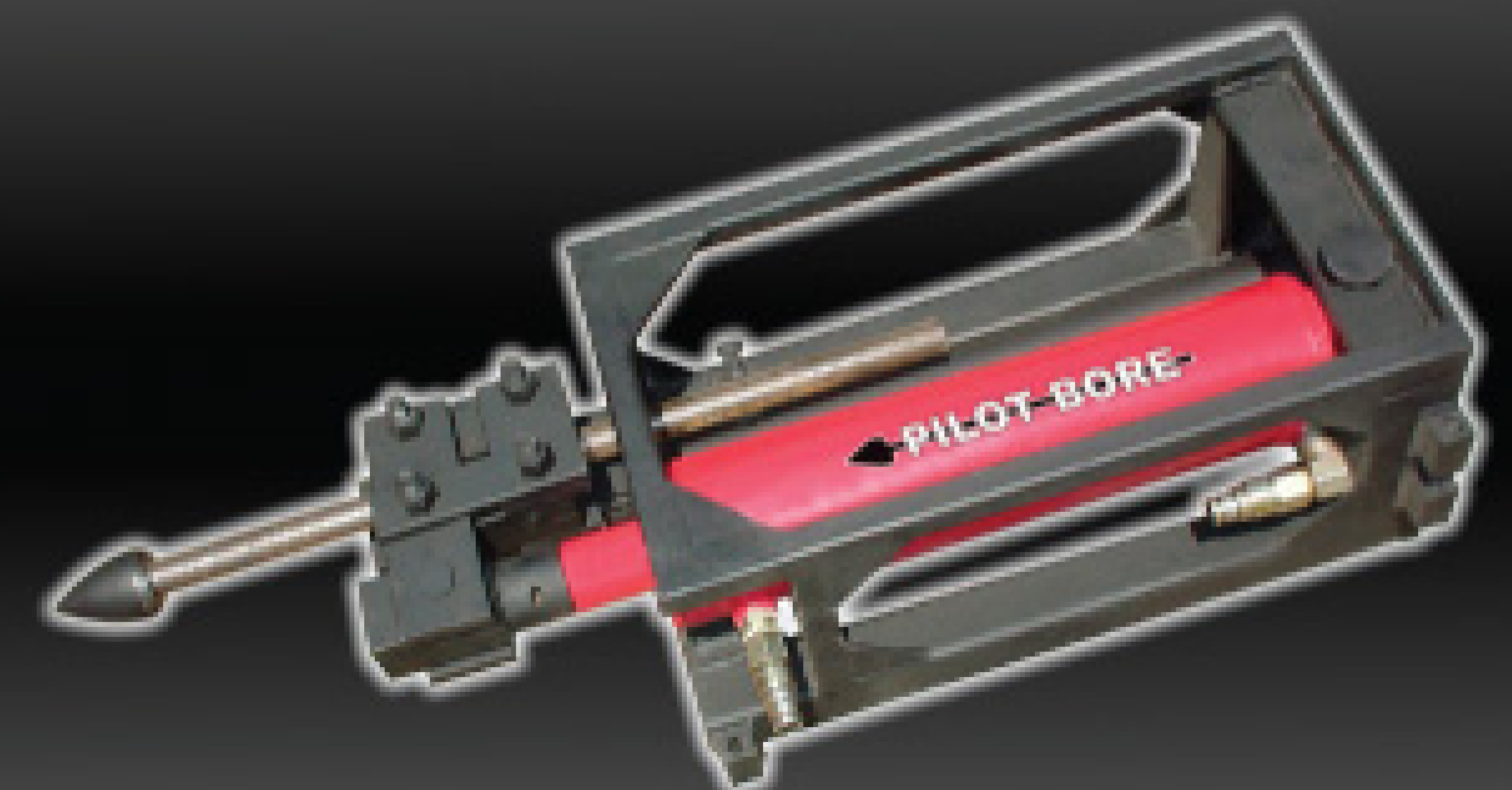

2-in-1 Convenience Bore then Pull!

Bore through existing lines or create new ones. When complete transform into a hydraulic pulling unit & haul back the new pipe!

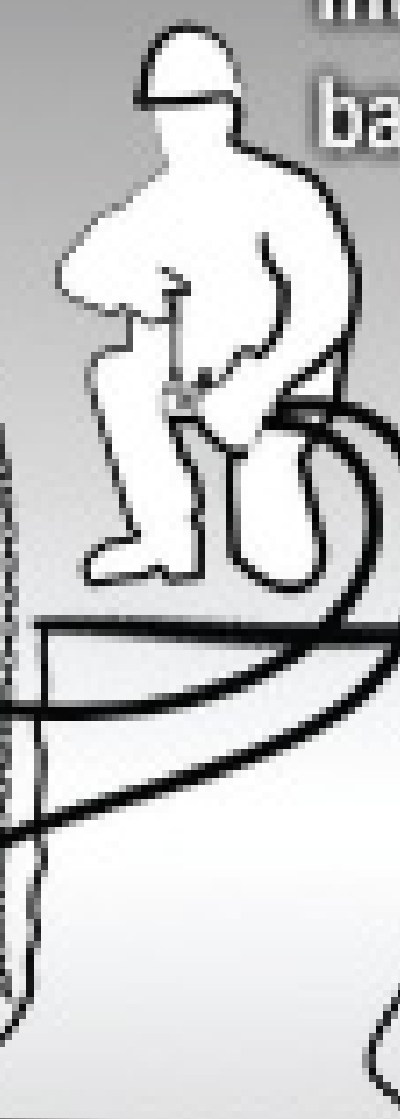



The **Fastest Growing Name**
In Drain Cleaning Machines

Thank you for visiting us in Louisville!



Now With DVD



Thank you for visiting us in Louisville!



Speedway Offers a Complete Product Line of Contractor Tough, Plumber Approved Designs. You Can Count On **Speedway** To Deliver Unmatched Performance & Value. For More Information And A 2008 Catalog, Call Or Visit Our Web Site
1-800-835-2200 www.speedway-tools.com

WMI INC.

Innovation in Industrial Equipment

Tracked power carrier TRANSPORTER

The Transporter is the newest all-terrain workhorse in the Pumper Cleaner Industry!

Extend the capabilities of a high pressure hydraulic cleaner into normally inaccessible areas such as WETLANDS, WOODED AREAS, NARROW ALLEYS, practically anywhere.

DEMONSTRATIONS
AVAILABLE IN
THE SOUTHEAST!
(call for details)

- Outstanding maneuverability
- All-Terrain
- Easy operations
- Self-propelled / Hydraulic steering



ALL-TERRAIN WORKHORSE

28325 Vargo Lane
Elberta, AL USA 36530
800-503-0076 800-654-1218
www.wmitsh.com
wmitsh@gulftel.com

DYE TRACERS

Solutions for:

- Infiltration
- Septic Systems
- Cross Connection
- Leaks and more...



www.brightdyes.com | FAX: 937-886-9300



Certified to
ANSI/NSF 60

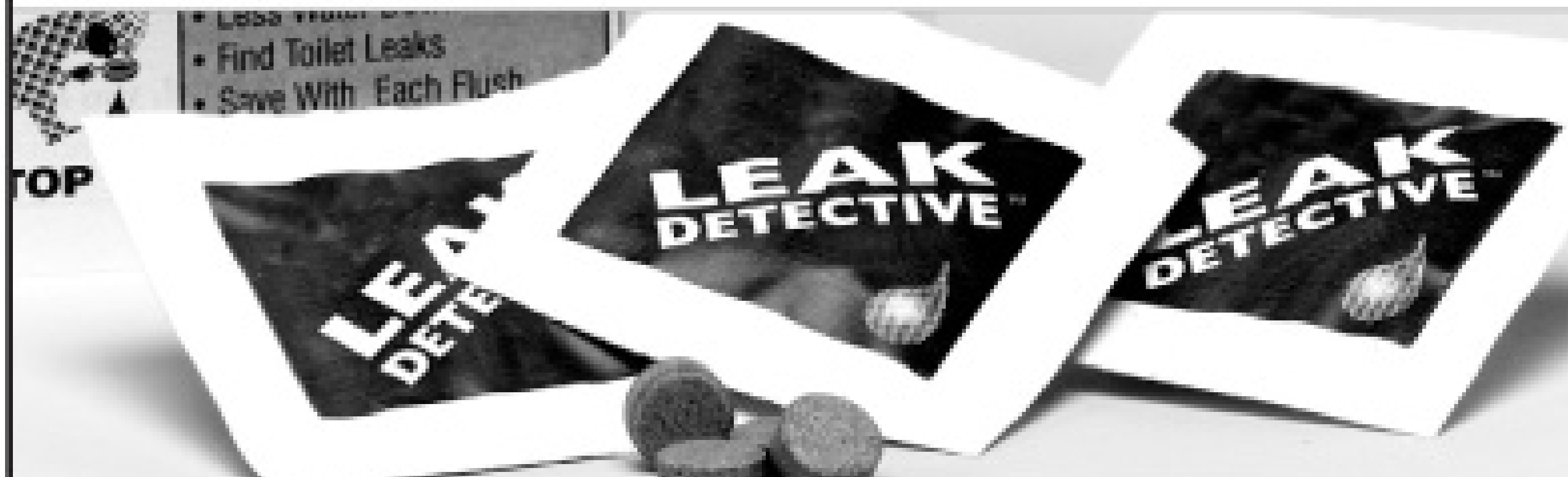

FREE SAMPLE 1-800-394-0678

Ratech Electronics Limited

Thank you for
visiting us at
the Pumper
and Cleaner
Show in
Louisville

CCTV video pipeline inspection
systems & equipment

ELITE SD
For the Plumbing Professional



ULTRA
COMPACT &
LIGHT WEIGHT

- Light weight portable inspection system for pipes 2" to 12" in diameter
- Super compact size - light weight 10.4 lbs
- Records digitally directly on a SD card
- On-Screen display of Distance, Data, and Time/Date
- 9" High resolution flat LCD monitor

Available with our NEW
Self-Leveling Color Camera!

toll free: 1-800-461-9200
905-660-7072
www.ratech-electronics.com



See Everything.

Then and Now

Contractors explore how the industry has changed and how those changes affect the way they operate their businesses

By Mary Shafer

Every so often, every business owner takes a breather from the daily grind. It's only natural at such times to pause and reflect on the larger picture to see what's going on in the industry. You've heard it before: The only thing that stays the same is change.

With myriad developments in technology each year, cleaning businesses are undergoing as much change as in any industry. Everything is affected, from back office management and dispatching to the tools and equipment you use in the field. Here, operators share their thoughts on trends affecting their businesses and how they're responding as planners and managers to stay ahead of the curve.

It's been nearly 40 years since **Rocket Rooter** opened, and much has changed in that time. One of the big changes has been the arrival of the original owner's son, **Doug Belcher Jr.**, as co-owner.

The firm splits its billings roughly in half between commercial cleaning — mostly restaurant grease traps, drain cleaning and camera line inspection — and septic

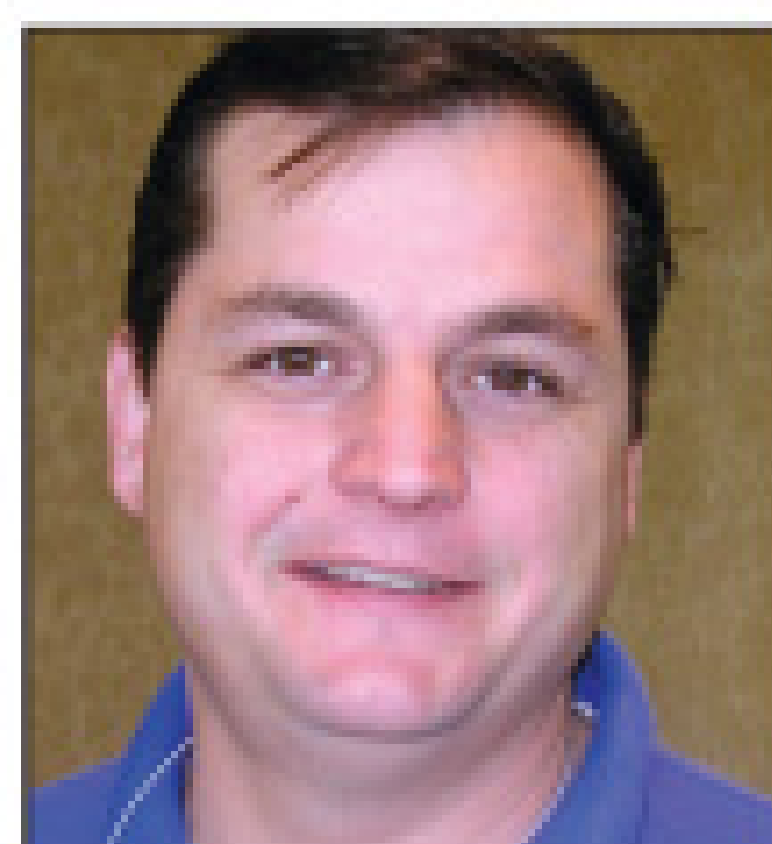

Doug Belcher Jr.

Co-Owner
Rocket Rooter
Rockville, Md.
Employees: 8

system pumping and repair. The biggest change Belcher has noticed has been an evolution in the billing process.

"It used to be we'd do strictly time and materials billing, but I think our newer, straightforward pricing — a set fee for a certain type of job — just works better. It's better for the customer, because

"It used to be we'd do strictly time and materials billing, but I think our newer, straightforward pricing — a set fee for a certain type of job — just works better."

Doug Belcher Jr.
Rocket Rooter
Rockville, Md.

they know what they're going to pay up front, before we even get started. No surprises.

"And it's better for us, because it keeps us on our toes. To be profitable, we have to be consis-

tently efficient. It works as a training incentive so our guys can do the job fast and do it right the first time. That also means keeping up with new tools and equipment, so we make educating ourselves a priority."

Jason Sears has run **Versatile Worx** for three years, just over the border from Seattle, Wash. In that time, he has been keeping an ear to the ground for future trends,



Jason Sears

Owner
Versatile Worx Ltd.
Vancouver Island, B.C.
Employees: 1

and he believes he has identified one that will kick-start his business growth.

"Hydroexcavation is where we're headed," he says. "We're doing well with drains, installing perimeter drains and septic fields, but I've been going to educational sessions about this process. It's just so much faster."

Sears is exploring the best way to add the service. "The equipment isn't cheap, and I haven't had any specific inquiries yet, so I can see looking for an investor," he says. "But this is definitely what the future holds for us. It's a fantastic, useful technology with lots of applications. I bet no one has even thought of them all yet."

The enthusiasm of youth notwithstanding, a few years in business can temper your outlook, as **Mark Subola** of **Mark's Reddi-Rooter** knows. He inherited the business from his father. Mark seriously disliked it as he grew up, "But then I realized it was a good way to make a living, that I could own my own business and make my own decisions."

Subola has found, after 17 years in the business, that he needs to approach management decisions with much more planning. "Five years ago, I was happy with just the business we were doing at the time, and I focused on day-to-day operations. Then, two years ago, I came to Nashville for my first Pumper & Cleaner Expo.

"I became aware that it was time to make a serious business plan and some plans for the future. I've learned a lot, and it has given me a basis for some serious potential that I can create for myself and the guys who work for me."

What started him thinking in that direction? "You can have a bad year, or see someone you love have a serious medical issue, and it really can make you re-evaluate," he says. "You realize

Comments may be directed to Mary Shafer in care of Cleaner. You may also e-mail pipelines@cleaner.com.



you have to plan, because some day, you're going to have to retire.

"These are things you just don't appreciate in your 20s and 30s. When you're young and strong, you can drag that equipment around all day long and it doesn't bother you. But pretty soon, you realize you're missing out on a lot of things because you're working all the time. You're too busy making a living to make a life.

"I think lots of people in my position are taking a good, hard look at how they're making decisions. It's important never to lose sight of the

"I think lots of people in my position are taking a good, hard look at how they're making decisions. It's important never to lose sight of the original goals you had when you were younger. I think a lot of us, as we get older, change a lot as people. We can lose sight of what inspired us in the beginning."

Mark Subola, Owner
Mark's Reddi-Rooter
Madison, Wis.

original goals you had when you were younger. I think a lot of us, as we get older, change a lot as people. We can lose sight of what inspired us in the beginning."

Part of what causes this loss of vision can be burnout. "We can work too much," Subola says.



"You've got to make some time for yourself and the other people you want to

Mark Subola

Owner
Mark's Reddi-Rooter
Madison, Wis.
Employees: 8

keep in your life. It's hard to find a balance, especially when you're self-employed.

"There are a lot of loose ends that can fill your mind when you're not at work, but you have to focus and be present. When you're with the people who matter to you, you have to check in a lot more with them, and be there. You have to decide what your priorities are and then build and work your business plan accordingly." ■

Now Available Trojan drain machines!

Colt - the drum size can be changed in seconds for different applications. Cleans 1"-4" sink lines for drains, shower and tub lines.

Pony - weight and durability make this machine great for residential areas, basements and roofs. Cleans 1.5"-6" outdoor lines.

Stallion - outstanding performance for larger lines and root cutting. Cleans 3"-10" lines up to 300'.

Affordable, durable and portable.



COLT



PONY



STALLION

Call or visit us online
1.800.421.4580
www.draincables.com

4370 Moline Martin Road
Millbury, OH 43447
PH: 419.838.6090
FAX: 419.838.6071

a division of Service Spring Corp.
DRAINCABLES
direct

Rental and Leasing Services Available!
Call Today!

Call For
FREE DVD

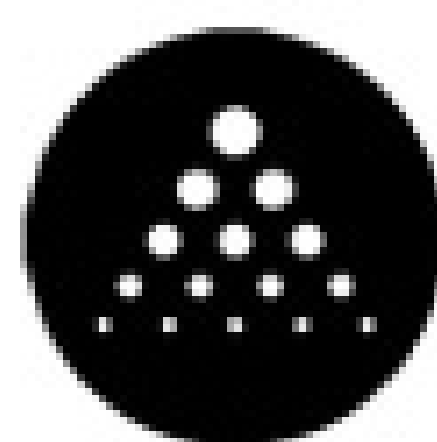

NozzTeq™
Taking Science to the Sewer!™

Equipment Engineered for
Long Lasting Performance.™

Phone: 1.866.620.5915 Fax: 603.413.6744 www.nozzteq.com

Ratech Electronics Limited

Thank you for
visiting us at
the Pumper
and Cleaner
Show in
Louisville

CCTV video pipeline inspection
systems & equipment

MINI PEEK
For the Plumbing Professional

- New affordable entry level system
- Portable inspection system for pipes 2" to 8" in diameter
- Ultra compact size and easily transportable - 25lbs
- Built-in 512Hz transmitter
- 1" Ruggedized B/W Camera
- 100 feet of cable
- RCA jacks for VCR or DVD recording

**Compact and Light Weight
All-in-One System**

toll free: 1-800-461-9200
905-660-7072
www.ratech-electronics.com



GEL ROD
CABLE

ULTRA
COMPACT &
LIGHT WEIGHT

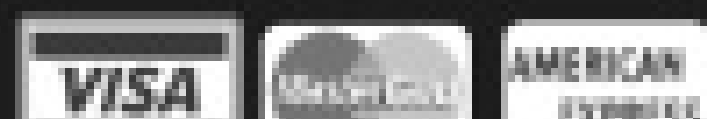

See Everything.

FRANCHISE NEWS

K. Scott and Pam Hobbs, Ken Hobbs
Mr. Rooter® franchise in Panama City, Fla.
Est. 2004

K. Scott Hobbs began his plumbing career in new construction in 1989. But after going through the typical struggles a new construction plumber goes through, Scott and his father Ken ventured into the service side. Following a few years of no sustained growth, they turned to Mr. Rooter, which Scott calls “a perfect match.”

In 2007, they received the Personal Achievement award, which acknowledges outstanding achievement in sales, manpower growth, personal growth or franchise development.

Why did you buy a Mr. Rooter franchise?

I knew I had to align myself with an organization that could help us grow to the potential I know we have. My father and I visited the Mr. Rooter corporate office and were impressed with the integrity of the entire staff and their willingness and ability to help us grow. After looking at other organizations, we found Mr. Rooter to be a perfect match.

My father and I visited the Mr. Rooter corporate office and were impressed with the integrity of the entire staff and their willingness and ability to help us grow.

How has your business changed since you became a franchise owner?

In 2000, we slowed down our new construction company of 40 plus employees to a profitable and manageable size and started a separate company to focus on only service. We ran the new shop for a few years trying to grow. I would get up to three trucks and then back down to one truck.



For Scott Hobbs (pictured far right), it's rewarding to work with his family: father Ken, daughter Brandi and wife Pam.

We started our Mr. Rooter franchise in 2004 with one technician and one helper. By learning an established system and having the ability to tap into decades of experience from other Mr. Rooter franchisees, we've grown to eight technicians.

...we've grown to eight technicians.

What is the biggest benefit of owning and operating a Mr. Rooter franchise?

I can't imagine trying to build this company, stay ahead of the competition and survive through challenging economic times without the guidance, training and support we receive from the Mr. Rooter Corporation as well as all the other Mr. Rooter franchisees.

With the help of Mr. Rooter we have a business plan to more than double the current size of our company over the next few years.

What do you see in the future for your franchise?

With the help of Mr. Rooter we have a business plan to more than double the current size of our company over the next few years. We have a lot more to learn and a lot of growth to achieve. My wife and our daughter have joined the company to help with the growth.



IS FRANCHISING RIGHT FOR YOU?

Find out today at
800-298-6855.

Or visit us online at
www.MrRooter.com
and click on
“Franchise Opportunities.”

Learn how the established systems and on-going support of Mr. Rooter can help start or grow your business.

Exclusive territories are available nationwide and in Canada.

Are you ready to take your business to the next level? Call today and find out what Mr. Rooter® can do for you.

This advertisement is not an offering. An offering can only be made by prospectus. Mr. Rooter MN Reg. No.: F-2356. 1020 N. University Parks Dr. Waco, TX 76707

METAL SEPTIC TANK MARKERS
A Great Way To Advertise And Grow
Your Septic Service Business!



Adhesive or 6" PVC Ground Anchor Installation Available.

- 4" Disc - Aluminum or Stainless Steel 16 Ga.
- Deep 3D Embossed Copy for Permanent Legibility
- 10 to 30 Year Warranty
- Laser Engraved Custom Copy Insert



800-248-2080
www.almetek.com

908-850-9700
908-850-9618 Fax

Almetek Industries, Inc.
2 Joy Drive
Hackettstown, NJ 07840



**GET MORE JETTER
FOR YOUR DOLLAR!**



Full Featured Jets with Powered Reels:

- SK4007V 23 h.p. Briggs 7GPM @ 4000 PSI... \$9950
 - STB2511H 24 h.p. Honda 11 GPM @ 2500 PSI... \$11699
 - SK3012K 29 h.p. Fuel Injected Kawasaki 12 GPM @ 3000 PSI... \$13995
 - STB2020V 35 h.p. Briggs 20 GPM @ 2000 PSI... \$19699
 - STB4018DT 49 h.p. Hatz Quiet Diesel 18 GPM @ 4000 PSI... \$39950
- Trailer Models starting at \$7499

www.camspray.com

800-648-5011

**KEN-WAY Beats the Others
DAY-IN • DAY-OUT**

And they have for over 50 years

KEN-WAY CABLE CLEANERS

for cleaning sewer, drain or process lines
from one to ten inches, up to 75 feet
with the Junior and up to
a full length of 300 feet
with the Model 400



**KEN-WAY
Exclusive Built Cables**

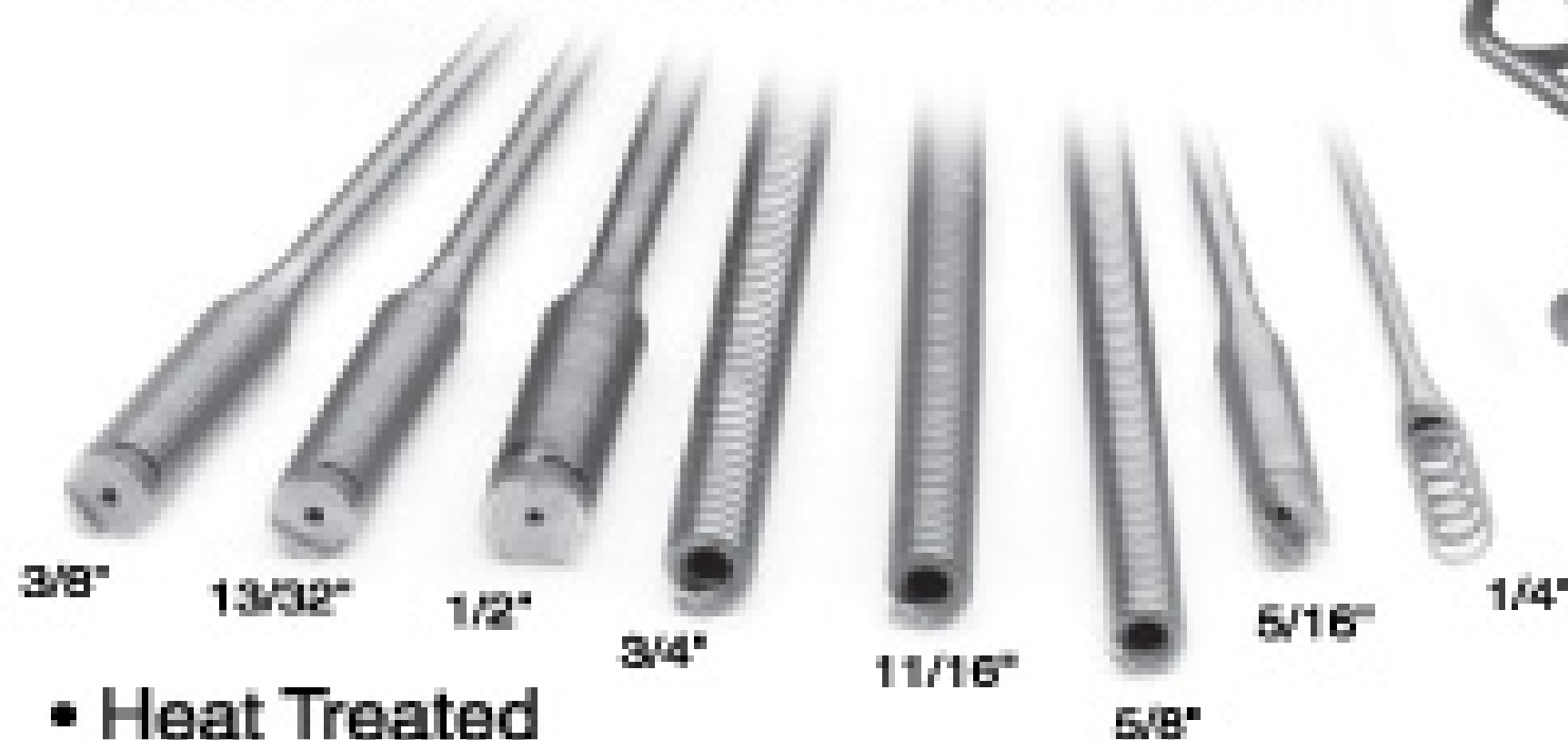

- Heat Treated
- Inner-Core or Non-Core
- Fit Most Other Brands
- Interchangeable with Most Brands
- Coupling or Blade Holding Types



Leasing plans available. Call for details.
1-800-533-0551

930 ROBERTS ROAD, SPARTA, WI 54656
www.ken-way.com • E-mail: info@ken-way.com

**Ratech
Electronics Limited**

Thank you for
visiting us at
the Pumper
and Cleaner
Show in
Louisville

**CCTV video pipeline inspection
systems & equipment**

PLUMBER'S MATE
For the Plumbing Professional

Push or Crawl ... it is up to you!
Interchangeable Push or Crawl System

Ratech systems can now be
used as both a push AND a
crawler system

Simple connector links crawler
to existing camera system

Uses the TORPEDO crawler to
inspect 4-8" pipelines

Simple kit allows you to change from
a push to crawl system under 5
minutes

**NOW COMPATIBLE WITH RATECH
MAINLINE CRAWLERS**

toll free: 1-800-461-9200
905-660-7072
www.ratech-electronics.com



See Everything.

Great Grab!

By Jim Kneiszel

To drain cleaner Allen Lewerer, quality service includes helping to keep marriages happy. Lewerer, co-owner of Mr. Rooter of St. Croix County in New Richmond, Wis., made television newscasts and newspaper headlines by cleverly using technology to fish a customer's long-lost wedding ring out of a clogged drain pipe.

Carey and Charlotte Moe called Lewerer to their home to flush a slow-draining sewer pipe. He cleared 60 feet of 4-inch cast iron pipe and flushed it with a hose to make sure it was clean. Then, examining the job with his MyTana color push camera with self-leveling head, Lewerer noticed what he thought was a scrap of copper pipe in the line.

Moe, looking at the same video picture, insisted it was the wedding ring that fell down the kitchen sink about 12 years ago. He told Lewerer he didn't have to take any extreme measures to retrieve it, but Lewerer insisted on pulling the ring out.

Lewerer attached a 3-inch pigtail retriever to his MyTana M81 The Big Workhorse cable unit

and sent it 32 feet into the pipe. Carefully twirling the retriever just in front of the camera, he hooked the ring with the pigtail bit and slowly pulled the camera and cable back.

He dropped the ring about halfway back and had to snag it again. Then, when he got to the vertical cleanout, he wedged the camera against the pigtail and lifted. "I knew that as soon as I lifted it, I would lose the ring," he recalls. "So I pushed the camera against the retriever, lifting the camera and cable all up at once. I was going to try my damndest to get it out."

The rescue took about an hour, and Moe was happy enough to give Lewerer a \$20 tip. "He didn't have to give me anything," Lewerer says. "The biggest reward is being able to help a homeowner like that."

Lewerer returned the favor with a \$50 gift certificate to a local restaurant so the Moe's could celebrate the rescue of the ring. "I thought it was appropriate to send them out to supper," he said.

For information on the tools Lewerer used, call 800/328-8170 or visit www.mytana.com. ■

Carey Moe with his recovered ring.

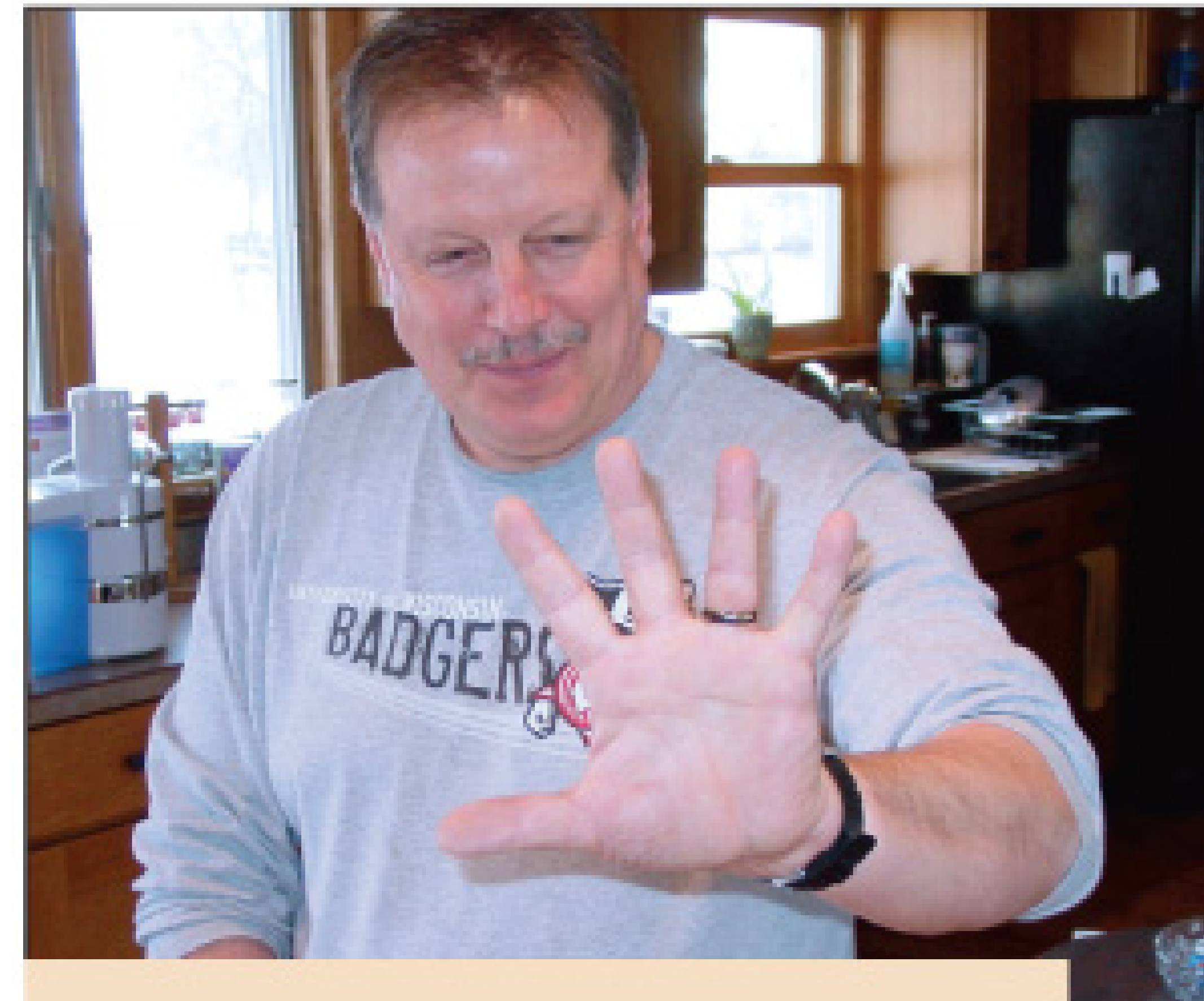

SHARE YOUR BRAINSTORMS

Have you found a way to make technology work better for you? *Cleaner* would like to share your ideas for taking the cleaning industry to the next level of excellence. E-mail your Brainstorms ideas to editor@cleaner.com. If you like, you can send pictures of how your idea makes work life easier, safer and more productive.

		<p>1-800-333-9274 East * 1-800-786-9274 Custom 1-800-351-7283 HONDA Parts * 1-800-964-9274 1-800-454-9274 Open Till 7:00pm West</p>				<p>* Apply For 30 Day Terms Account * Low Interest Lease Plan * 5 Offices To Serve You * Free Lifetime Tech Support</p>		
<p>SWIVELS</p> <p>Mosaic & Super Swivels \$22.10 & Up</p> 	<p>BYPASS VALVES</p> <p>From 500-7000PSI 120 Models In Stock \$19.99 & Up</p> 	<p>TRIGGER GUNS</p> <p>Extreme Duty From \$7.99 & Up</p> 	<p>HOSE REELS</p> <p>200' Manual Reel \$79.99</p> 	<p>Portable Hose Reels</p> <p>250' \$299 350' \$349</p> 	<p>HOSES</p> <p>Up To 5800PSI 316Deg F. Rated Up To 200' \$29.99 & Up</p> 	<p>TURBO NOZZLES</p> <p>Up To 6000PSI Best Seller 4500PSI Only \$39.99</p> 	<p>PRESSURE GAUGES</p> <p>Stainless Steel Industrial Quality Up to 6000PSI Only \$5.99</p> 	<p>BALL VALVES</p> <p>Ball Valves Brass, Steel & Stainless Steel New 6000PSI Stainless From \$23.99</p> 
<p>Honda Engines</p>  <ul style="list-style-type: none"> * 5Hp GC \$199 * 6.5Hp GX \$349 * 8Hp GX \$459 * 9Hp GX \$489 * 18Hp GX \$1,099 	<p>Honda Twins</p>  <ul style="list-style-type: none"> * 18Hp GX610K1 \$1,099 * 20Hp GX620K1 \$1,279 * 24Hp GX670T \$1,599 	<p>Compact Electric Hand Carry</p>  <p>\$649 EHC2015G 2GPM @ 1500PSI</p>	<p>Compact Honda Hand Carry</p>  <p>Includes Pulse Valve \$799 HJ3028HC 3GPM @ 2800PSI</p>	<p>Hose Reels All Types Available</p>  <p>200' Portable As Shown \$165.98</p>	<p>LT Replacement Engines</p>  <p>Recoil & Electric Start Available</p>	<p>CAT Pump Volume Distributor</p>  <p>Complete Pumps Plumbed From \$179</p>		
<p>Customized Electrics</p>  <p>Auto Stop/Start Hose Reels, Etc</p>	<p>BEST Sellers ALWAYS on Sale</p>  <ul style="list-style-type: none"> 5.6GPM @ 4000PSI \$399 8.0GPM @ 3500PSI \$499 7.0GPM @ 5000PSI \$599 <p>Call For Free Quotation. We Also Stock Pumps With Left Hand Drive, Tapered Shaft, Car Wash Duty, 316 Stainless Steel and Unique Applications 1-800-964-9274</p>	<p>High Performance AR Pumps</p>  <ul style="list-style-type: none"> 13GPM @ 1450PSI \$579 11GPM @ 3000PSI \$629 5.8GPM @ 7250PSI \$1,099 10GPM @ 7250PSI \$2,899 44GPM @ 1500PSI \$4,199 <p>We Stock 1000's of Pumps For Same Day Shipping!</p>	<p>New On Board Hose Reel Option</p>  <p>50' x 100' Available On Some Models</p>	<p>Hose Reels Up To 350' Capacity</p>  <p>Jetter Packages Available All Sizes</p>	<p>Replacement Pumps</p> <p>1-800-454-9274</p>  <p>Up To 41GPM Up To 7250PSI</p>	<p>Replacement Coil Specialists</p>  <p>For Hot Water Pressure Washers</p>		
<p>Truck or Trailer Mount</p>  <p>Skid Mount & Tank Feed Options Available On Some Models</p>	<p>Hydraulic Drive Pressure Washers</p>  <ul style="list-style-type: none"> 3.0GPM @ 2000PSI \$539 4.0GPM @ 2200PSI \$649 4.0GPM @ 3000PSI \$689 <p>Call For Details & Hydraulic System Requirements 1-800-454-9274</p>	<p>Cleaning Heads</p>  <p>Full Line Of Cleaning Heads Available</p>	<p>Up To 8GPM Hot Boxes</p>  <p>Adjustable Thermostats, Jumper Hoses & Options Available L.P. Diesel Models Available</p>	<p>HONDA Best Seller</p>  <p>\$2,999 4000PSI Hot 4040HG-115</p>	<p>Frames & Frame Parts Available</p>  <p>Belt & Direct Drive With Custom Options</p>	<p>Mobile Wash - Detailer System</p>  <p>Self Contained On Board Water Supply</p>		

SEWER Equipment & Supplies

Custom built hydro jetting units with flows over 36 GPM and pressures up to 6000 PSI

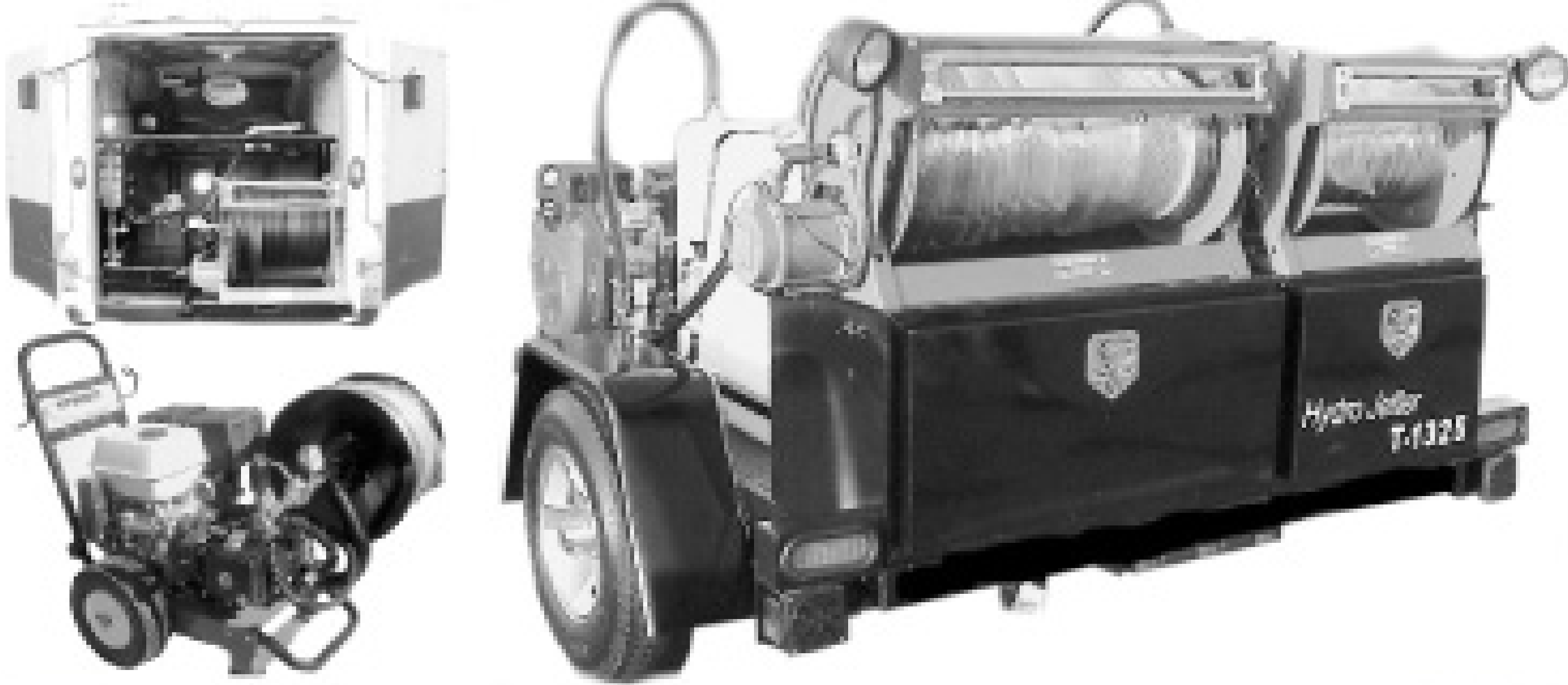

Trailers • Enclosed Units • Gas Powered Carts • Skid/Van Units • Electric Units • Hoses • Nozzles & Much More.

- T - 1440-200 14 GPM @ 4000 PSI starting at \$15,000
- T - 2030-300 20 GPM @ 3000 PSI starting at \$17,999
- T - 1325-200 12.5 GPM @ 2500 PSI starting at \$8,999
- C - 630 cart unit 6 GPM @ 3000 PSI starting at \$1,999

Gas • Diesel • Anti-Freeze Systems • Large Capacity Reels & More
We offer over 30 different models and have units starting at \$7,300

For all your jetting needs please call 202-330-8395
www.sewerequisiteandsupplies.com

The SOIL SURGEON™

The **MOST POWERFUL**
HYDRO-EXCAVATING TOOL
ON THE MARKET!

Use your sewer combination truck to:

- **LINE LOCATE** • **POTHOLE**
- **TRENCHING** • **BASIN CLEAN**
(within minutes)

- Fits all truck manufacture designs
- Quick connects to 8- or 6-inch boom
- You control water flow pressure and power with the truck's controls
- Is designed to cut through all types of soil

Features include:

- 6-foot tuff tube
- "Y" connection for water and/or air
- Handles for easy maneuvering
- Water ring with tips boring inward to cut the soil and outward to get tube down
- Bumpers on bottom to protect tips and line



SOIL SURGEON INC.
Patent #6,484,422B1

NEW AND
IMPROVED STEEL PIPE
THAT REPLACES HOSE!
REPLACEMENT KITS
AVAILABLE FOR
CUSTOMERS WHO HAVE
OLD MODEL.

Call For A Free Video and Info. on Your Nearest Distributor
949-363-1401 • www.soilsurgeoninc.com

AMerik FIBER Spot Repair

Engineering, Inc. Point Repair for Sewer and Storm drains

Benefits:

- Keep rehab work you find in your company
- Calculations and support for municipal acceptance
- Complies with ASTM 2019 liner specifications
- Competitive price, low first cost, no license fee
- Field training and support • Territories available

Before



After



Proprietary Features:

- Proven product with 10 year history
- Liners 6 to 45 inch diameter and 2 to 150 feet long
- No plugs required, works in various pipe cross sections
- Flexible liner folds and bends easily for manhole entry
- Positive 45 minutes steam cure in hot or cold weather

Contact Erik Nielsen (770) 335-3201
for available territories, product information
and pricing or submit request thru web site
www.AMerikSupplies.com

AMerik Engineering, Inc.
2600 Ainsley Ct., Marietta, GA 30066

Ratech Electronics Limited

Thank you for
visiting us at
the Pumper
and Cleaner
Show in
Louisville

CCTV video pipeline inspection
systems & equipment



GEL ROD
CABLE

ELITE DVD RECORDER
For the Plumbing Professional

- Light weight portable inspection system for pipes 2" to 12" in diameter
- High quality DVD recorder with built-in Hard Drive
- Includes built-in 512Hz transmitter
- On-Screen display of Distance Counter, Data, and Time/Date
- 15" High resolution flat LCD monitor



Available with our NEW
Self-Leveling Color Camera!

Leasing
Available

toll free: 1-800-461-9200
905-660-7072
www.ratech-electronics.com



See Everything.

TUBELAND

**Available in
6" & 8" Diameter**

- Intakes
- Catch Basins
- Extensions

UEMSI
PIPELINE CLEANING & TELEVISION EQUIPMENT

Corporate Office: 1.800.666.0766 • Fax: 1.800.691.0031
www.uemsi.com • E-mail: info@uemsi.com

BUY NOW

"Vacuum Tubes" For Combination Trucks

We Accept:

TUFF TUBES
TUFFEST TUBE ON THE MARKET

THE CABLE CENTER 1-800-257-7209

Now Available **The Ridgid SeeSnake® Micro**
Inspection Camera

*** 24 HOUR TURNAROUND ***
MIDWEST'S LARGEST FACTORY
AUTHORIZED REPAIR CENTER FOR
GATORCAM, GEN-EYE
& SEESNAKE

Fully Adjustable
LED Lighting

Waterproof
Camera Head
and Cable

Flexible 3' Cable

Twist and Lock
Attachments

High Visibility 2.4" Color LCD

Comfort Grip

Protective
Storage Case

4-AA Batteries
Included

**CALL FOR
SPECIAL
PRICING ON
ALL CAMERA
KITS!**

**FREE
DELIVERY
ON ALL RIDGID
CAMERA
KITS**

RIDGID Durability Combined
with Digital Technology

- Record videos digitally onto DVD and view on the system or any DVD player.
- High resolution LCD provides superior picture quality, even in sunlight.
- Lightweight at just 25 lbs., for increased portability.
- Water resistant touchpad makes it easy to navigate controls and keeps hands off DVD recorder.

SeeSnake® LCD Monitor+DVD

• THE CABLE CENTER • 8318 OLIVE BLVD. • ST. LOUIS, MO 63132 • 314-993-3099 •

GLOBAL PIPELINER

WHOLESALE TO THE PIPELINING INDUSTRY

**"NO CONTRACTS, NO BULL,
JUST GREAT PRICING
AND SUPPORT."**

- 2" up to 110" through a single access
- Increase revenue by up to 1 million plus Dollars
- Cure times of 2 hours in any weather (no boiler needed)
- Training included
- Ongoing technical and marketing support
- In most cases compatible with your current equipment
- NSF & IAPMO certified
- Financing available



Designed by contractors for contractors. Global Pipeliner's superior products, training and support are what really set us ahead of the pack. Rather than restrict our customers "buying ability" or "areas of operation" with forced lengthy contracts or territory agreements, we here at Global Pipe choose to gain your business by simply providing great materials and support at an honest price. Some may call us naive, but we here at Global Pipe take real American pride in conducting business with an old fashion hand shake. Oh, by the way, All of OUR products are manufactured right here in the USA.



866.513.0998
WWW.GLOBALLINING.COM

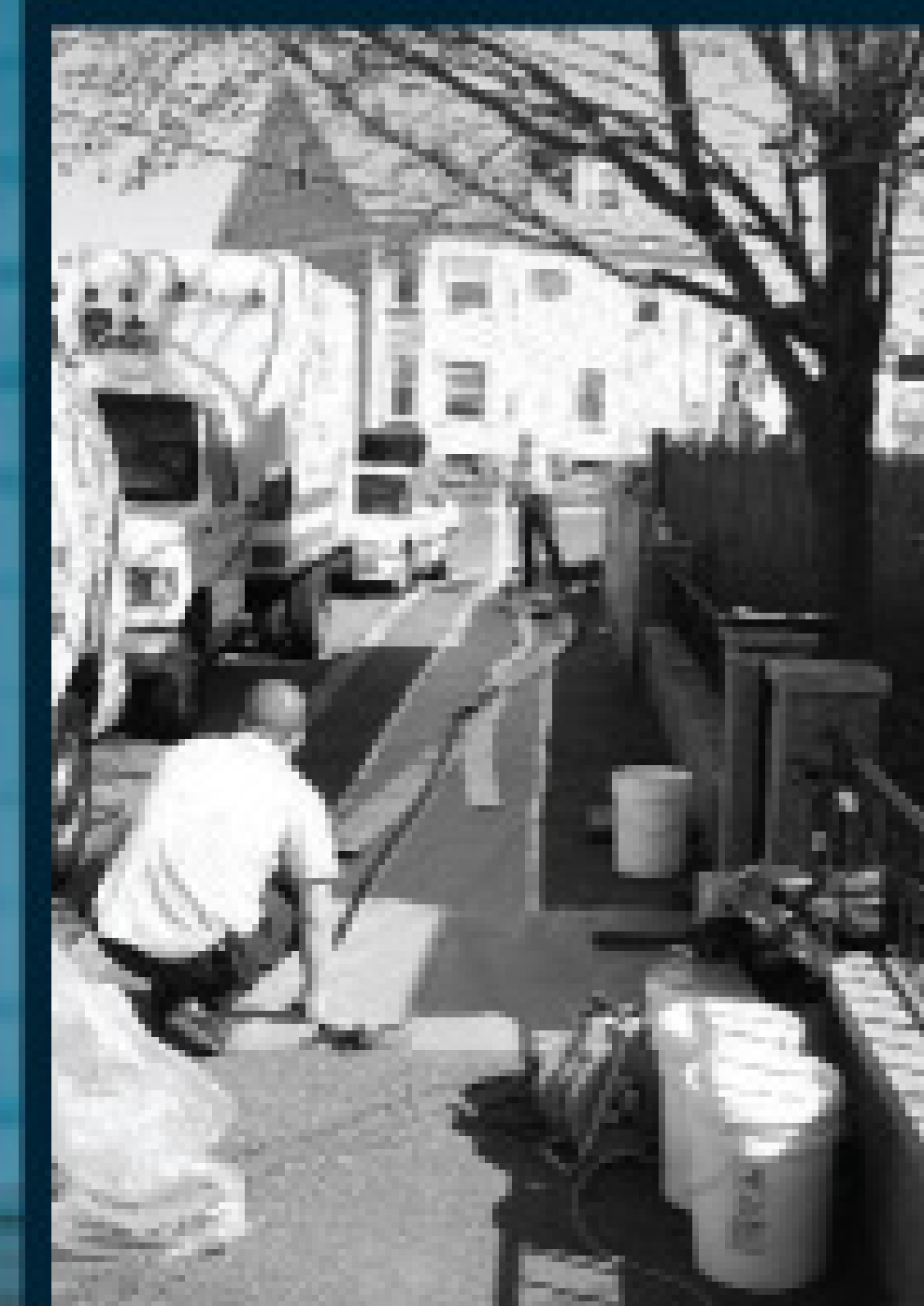

- ▶ Bucket Machines
- ▶ Businesses
- ▶ Business Opportunities
- ▶ Cable Machines
- ▶ Computer Software
- ▶ Dewatering
- ▶ Drainfield Restoration
- ▶ Drain / Sewer Cleaning Equipment
- ▶ Dredges
- ▶ Excavating Equipment
- ▶ Hazardous Waste Units
- ▶ Hydroexcavating
- ▶ Jettiers-Trailer
- ▶ Jettiers-Truck
- ▶ Jet Vacs
- ▶ Lease/Financing
- ▶ Locators
- ▶ Miscellaneous
- ▶ Parts & Components
- ▶ Pipeline Rehabilitation
- ▶ Portable Shower Trailers
- ▶ Portable Restrooms
- ▶ Portable Restroom Tanks
- ▶ Portable Restroom Trailers
- ▶ Portable Restroom Trucks
- ▶ Positions Available
- ▶ Positions Wanted
- ▶ Positive Displacement Blowers
- ▶ Power Washing
- ▶ Pressure Washers
- ▶ Pumps
- ▶ Pumps-Dredge
- ▶ Pumps-High Pressure
- ▶ Pumps-Submersible
- ▶ Pumps-Vacuum
- ▶ Pumps-Water
- ▶ Rodding Machines
- ▶ Roll-Off Containers
- ▶ Root Control
- ▶ Safety Equipment
- ▶ Septic Trucks
- ▶ Service / Repair
- ▶ Sludge Applicators
- ▶ Tanks
- ▶ Tools
- ▶ Trailers- Vacuum / Tanker
- ▶ TV Inspection
- ▶ Vacuum Loaders
- ▶ Vanes
- ▶ Wanted
- ▶ Wastewater Transfer
- ▶ Waterblasting

BUCKET MACHINES

USED BUCKET MACHINES, mechanical or hydraulic, parts and accessories. Call 416-248-4990. (C5)

Four bucket machines with all the buckets and accessories. One truck loader, three regular. Also one trailer mount rodding machine for sale. I no longer need the equipment. 440-946-9100. (C4)

BUSINESSES

AVAILABLE FOR ACQUISITION - Full service pipe inspection, cleaning and testing company. Seattle/Tacoma and Portland/Vancouver areas. Established customer base, increasing revenue trend, excellent profit margin. 15 years in business. Acreage with shop is also available. Priced to sell. 1-800-TV-A-PIPE. (C4)

FOR SALE: Septic and portable toilet business Located in Highland, MI. Family owned for 60 years. 3 pumpers, 1 portable toilet truck, 1 dump truck, backhoe, dozer, approximately 90 portable toilets. Excellent client base, residential and commercial. Selling price \$350,000. Further details for serious buyer only. 248-889-0483 or 248-420-7779; email jan7mom@sbcglobal.net. (P4C5)

SEWER SYSTEM INSPECTION AND REPAIR COMPANY: Central Florida area. Equipment includes, Cues CCTV, RFI manhole rehab system, internal point repair system, numerous plugs, pumps, chemical hose, tools and support equipment including two crew cab 1-ton pick-up trucks and 1-ton CCTV truck and customer list. Sale is for complete company with all equipment. \$75,000. Contact Bill Senick 407-687-4408 for complete equipment list. (C6)

FOR SALE: 23-year-old restaurant service company specializing in hood system cleaning and ceiling restoration. Serving WV, OH and KY. Large loyal customer base. Grossing average \$500,000. All vans, equipment and experienced service techs in place. \$300,000. Will train. 304-372-2158. (CP7)

BUSINESSES

Drain cleaning, jetting, plumbing business for sale in Myrtle Beach, SC. 3 trucks, jetter, all equipment. Strong customer base. Will consider holding plumbing license. Willing to train. 843-997-5570. (CBM)

BUSINESS OPPORTUNITIES

LOOKING TO SELL OR INTERESTED IN A JOINT VENTURE? Leading edge service and repair plumbing company looking for similar businesses in major metropolitan cities. Please email your contact information to j.stanley@rapidplumbing.net. (C6)

Very successful Sewer & Drain Franchise with excellent potential to expand into plumbing. Serving over 1 million population for 25 years. Turn-key. 4 vans, 2 jettiers, 2 cameras. Edmonton, Alberta, Canada. Call Larry or Melissa 780-456-5255. (C4)

WWW.ROOTERMAN.COM. Franchises available with low flat fee. New concept. Visit web site or call 1-800-700-8062 x26. (CPBM)

UNIQUE FRANCHISE OPPORTUNITY: WE DO THE MARKETING; WE ANSWER THE CALLS; WE GIVE YOU THE JOBS. YOU DO THE JOB; YOU GET THE MONEY. Areas available: New York, New Jersey & Connecticut. For more information call 866-324-5499 or visit our web site www.anysewerfranchise.com. (CBM)

DEWATERING

Alar, Model 650, very good cond. Completely automatic with all controls and panels, filters down to 1/2 micron, sludges generated by septic and grease haulers. Reducing BODs, F.O.Gs, TGS, total phosphorus, meters and NH3-N. \$35,000. 770-409-1615. (CP4)

IF YOU ARE USING AN 800 NUMBER

IN YOUR AD, BE SURE IT CAN BE USED IN ALL AREAS NATIONWIDE.

DEWATERING

DAF, 6X12 F.R.C. All stainless steel w/2 dissolved air pumps. Top paddle and bottom worm drive skimmers removes suspended solids particles and colloidal materials from liquid waste, such as fats, oils, grease, latex, pump and paper fiber. Treating approx. 140 gallons per min. \$23,000. 770-409-1615. (CP4)

DRAIN/SEWER CLEANING EQUIPMENT

Used and rebuilt cable machines, cameras, water jettiers and locating equipment. Ridgid K-7500, K-3800, K-1500, K-38, General Model Speed-rooter, T-3, Mini Rooter, rebuilt Spartan #1065 - \$1400; #100 - \$650. The Cable Center. 1-800-257-7209. (CBM)

EXCAVATING EQUIPMENT

2004 and 2006 Super Products Mud Dog Hydroexcavators for sale or rent. Call 330-270-9900 ext.3. (P3C4)

GLOVES

Brown Jersey (100% cotton), \$8.10 doz.; Case of Latex Exam Gloves, \$56.00; Case of Shoe Covers XL (200 pair), \$68.00. **ANY GLOVE IS AVAILABLE:** cotton, leather, PVC, latex, etc. **RAINWEAR ALSO AVAILABLE. ASK ABOUT CONTRACTORS SPECIALS!** Metro Industrial Supply. 888-358-1923. www.easygloves.com. (CBM)

JETTERS-TRAILER

2006 Spartan 798 jetter, 4000 psi @ 18 gpm. Only 25 hrs. Like new. \$25,000 OBO. In California. 209-854-1816. (CP4)

2003 Sreco jetter. Model HP4030 TR/L/P. 300 gallon tank. Gas engine. 28 gpm, 4000 psi. 500' hose. Flexi-cam and VCR monitor. Low hours. Ready to use. Will email more info & pictures. \$23,000. 860-793-4293 ext. 1003. (P3CM4)

JETTERS-TRAILER

Harben jetter 4016, pull out and pivot reel, Hatz silent, mini jet, nozzles, spray gun, 500' 1/2" hose. 1998. \$15,000. 678-313-0878. (C4)

1993 SECA Model 747 4000 trailer jet, 4 cyl. diesel, Myers pump, 18 gpm, 4000 psi. Was a city owned unit. 714-639-8352. www.empireequip.com. (CPBM)

New PipeHunter Model 38T44 jetting unit, trailer mounted, w/335 Poly water tank, 4,000 psi @ 25 gpm, 600' of hose and attachments. **In stock!!!** (Stock #13317) **www.VacuumSalesInc.com, (888) VAC-UNIT (822-8648).** (C4)

Ram Rodder Jetter, Myers pump. 300 gallon water tank, gas engine, hose & heads included. Older but runs good. \$6,500. Call Chris 770-439-3407. Atlanta. (C4)

Myers Camel Jet with 368 original hours, always garaged, 30 gpm, 2000 psi, 500' of 3/4" hose. Was city owned. Located in the Chicago area. 815-693-9986. (CPBM)

1995 Harben 4016, good shape, new hose, \$8,200. 2008 laser jet, 4000 psi, demonstrator, \$12,000. 1988 Aqua Jet trailer mount, 2000 psi, 40 gpm, great shape, new paint, wheels, and axles w/brakes, \$9,800. 702-456-5388. (P4C5)

2006 Spartan 758, less than 100 hours, extra nozzles, 250' 3/8 hose, wash down kit, w/468 root saw and blades, never used. Jet is in new condition. \$10,500. Steve 303-463-6730. (C6)

2 SECA trailer jets. Both have Myers 35 gpm, 2000 psi pumps. New paint on both. Located in Dallas. 972-938-1905. www.empireequip.com. (CPBM)

JETTERS-TRUCK

2006 GapVax MC1005/@005 Sterling 7500 NEW demo truck, Cat C7 275 hp, Allison 3060 80GM @ 2000PSI, 1000 gallon, 5 cu. yd., 3500 CFM vacuum, debris flush out system, wireless remote. \$219,500 plus FET. Call 1-800-338-7274 ext 1009. (C4)

JETTERS-TRUCK

1997 Sreco HV 2000 truck jet, 65 gpm, 2000 psi water pump, 1500 gallon aluminum water tank. Was a city owned unit. Located in Dallas. 972-938-1905. www.empireequip.com. (CPBM)

Vactor water jet on a 1998 Ford F-800, Cummins diesel, 17,338 miles, automatic, 1000 gallon water tank. Needs water pump. This truck is like new. 972-938-1905. www.empireequip.com. (CPBM)

2006 Chevy C5500 with a Pipe Hunter with a Jet Eye camera and vacuum system. (Stock #13234) www.VacuumSalesInc.com, (888) VAC-UNIT (822-8648). (C4)

JET VACS

1991 Camel 200, 6-speed, 65 gpm, 2000 psi, Roots 624 blower, tandem axle, ready for work, 169,000 miles, excellent condition. \$46,000. Call 920-655-7302 or 920-866-9109. (CBM)

1998 Vac-Con 2-stage combination cleaner, single axle, 9-yd debris body, International chassis w/62K miles, 65@2000 water pump, 1000 gallon poly tanks, front 600' extension hose reel, 6' boom extension, 1700 hrs. on auxiliary diesel engine, many extras, very good machine, city owned. \$73K OBO. Call Mark @ 515-681-6321. (C5)

Jack Doheny Supplies Inc. offers a full range of late model combo units and DOT industrial vacuum loaders. Call us @ 1-800-3DOHENY. (CPBM)

1989 2110-C, L8000, new paint, 80 gallon, 2,000 psi pump rebuilt in 2007, 10 cu. yd. debris tank, rubber coated, telescoping boom, new boom hose 2007, articulating hose reel, 600' hose, one-stage fan replaced in 2007, 8' extendable boom, new vac tubes, with Vactor Higbee, new extending catch Payson tube, root cutter, saws and ripper cutter, nozzles, plus culvert clean nozzles. \$50,000 OBO. Well taken care of truck. Will consider trade plus cash. Ph 309-853-5270. (C4)

1990 Aquatech B-10 (strong vacuum pump - new gear box), Meyers pump, 2000 psi, 80 gpm, International with automatic transmission. Price \$60,000. Call 503-969-9557 or 503-682-2723. (C4)

JET VACS

1997 VacCon V390THA on a Ford, 3-stage fan, articulating hose reel, extendible boom, new white paint. Located in Dallas. 972-938-1905. www.empireequip.com. (CPBM)

2007 VACCON, 12-yd. debris, mounted on an International, 22,690 miles, auxiliary engine, 1878 hours, 15' telescoping boom, 80 gpm/wireless remote control for boom/debris tank, 3000 psi, 500' 1" hose, hydroexcavating package, automatic winter recirculation. Great deal. Call 303-237-4209. (CBM)

1999 Vac-Con, 12 cubic yard on International, factory rebuilt engine 2005, running complete, 63,436 miles, 80 gpm, 2000 psi, PD, Spicer trans., articulating hose reel. \$98,000. 610-692-9160. (CPBM)

2002 VacCon V390LHA on a Sterling L7501, articulating hose reel, 10' extendible boom, 3-stage fan, pump-off system, 65 gpm, 3000 psi pump, new paint, excellent condition. Located in Dallas. 972-938-1905. www.empireequip.com. (CPBM)

1981 Vactor 810, great condition, on GMC Brigadier chassis, rebuilt diesel/diesel, 2000 psi/60 gpm, new 500' hose, 35K miles. \$26,500 OBO. www.direct-current.com/vactor. Call Aaron 248-921-1910. (CBM)

2003 Sterling LT7501 with a Vac-Con Model VPD4216 LHA / 1300 combination vacuum-jetter unit. (Stock #4648C) www.VacuumSalesInc.com, (888) VAC-UNIT (822-8648). (C4)

VacCon model VPD4209 THA on a 1997 Ford, PD blower, 4200 cfm, articulating hose reel, extendible boom, new white paint. Was a city owned unit. In excellent condition. 972-938-1905. www.empireequip.com. (CPBM)

1998 Vactor 2110 on a Freightliner FL80, 28,213 miles, 2-stage fan, 80 gpm, 2,000 psi pump off system accumulator. Was a city owned unit. Located in Dallas. 972-938-1905. www.empireequip.com. (CPBM)

Low hours, 1995 Vac-Con, 12-yd. debris, new water pump, newly rebuilt Roots blower, auto. trans., AC, tank vibrator, privately owned. \$65,000. 1-800-930-1123 or 954-981-2133. (CPBM)

JET VACS

1985 Camel, single axle Ford 8000, Meyers pump, 80 GPM, 2,000 PSI. Price \$17,000. Call 503-969-9557 or 503-682-2723. (C4)

2004 Vactor on International, 16' PD blower, OMSI gear box, 15,000 miles, 600 hose reel rotating & telescopic, 80 gal. @ 2000 psi, extendible boom. Asking \$187,000. Call Dan 561-310-4011, Todd 561-602-2397. (CBM)

1998 VacCon V312THA on a Ford LT8000, 3-stage fan, 65 gpm, 2000 psi pump, extendible boom, articulating hose reel, 12 yard debris tank, new paint. Was a city owned unit. Located in Dallas. 972-938-1905. www.empireequip.com. (CPBM)

1978 Ford L-800 with Vactor 810, gas/gas, ready to work. \$9,500 OBO. Call 262-548-9963. (C4)

LEASE/ FINANCING

North Star Commercial Credit: Commercial Loans for Trucks or Equipment. Flexible purchase programs to fit your budget. 21 yrs. in the industry. Contact **Tom Myers - 877-804-2274**. (CPBM)

MANHOLE REHABILITATION

Turn-key manhole rehab. trailer available for weekly or monthly rental. Includes delivery, pick-up and one operator. You provide 2 people to complete the crew. Call 610-582-6060. (CM5)

MISCELLANEOUS

Pipe Freezers: RoFrost Turbo 1-1/4" and RoFrost Turbo 2". Each unit is a self-contained 115V freezer unit. The small unit has 2 sets of clamps for 1/2" through 1-1/4" cu and the large unit has clamps for 1" through 2" cu. \$1,500 each. Pictures available at www.glueco.net. Call 1-866-781-9100 or bernie@glueco.net. (C4)

Water well camera, rated 5,000' depth, \$15,000; 800 Vactor, good working unit, \$10,000; Cues Pro-Data recorder, \$3,000; Cues television truck complete single conductor, needs camera, \$10,000; 1982 Vac-All jet and vacuum, \$18,000; Sewer cleaning bucket machines, best offer. Bob 763-444-5501. (C4)

MISCELLANEOUS

Top quality aerators at wholesale prices. We have replacement units for most name brands and also carry Linear Regenerative Rotary Vane pumps. Flagg Air, Gast, Thomas, FPZ, Secoh, Medo and more. Call a company that understands aerators and aeration systems. Septic Services Inc. 800-536-5564. (CPBM)

Champion continuous sewer rodder mounted on 1975 Dodge 300. Fair condition. Best reasonable offer. Jamestown Sanitary District, CA. 209-984-3536. (CM4)

PARTS & COMPONENTS

US JETTING provides aftermarket rebuilding services and **replacement parts for Harben® pumps.** Low prices, fast response. Why pay more? Call today. 1-800-538-8464, ext 25 or 18. (CBM)

PIPELINE REHABILITATION

Cues TV/Cutter Trailer: 2007 Evolution package, with or without camera, cutter or compressor. Call for specs. Financing available. Kelly 608-279-2299. (CBM)

One trade-in model of Pipe Genie heavy duty pipe bursting equipment. Excellent condition, looks new. 30-ton, 100 feet cable, full 2 year warranty. 877-411-7473. (CBM)

PORTABLE RESTROOMS

Portable Toilets: Poly constructed, molded seat, urinal, latching door. Handicap accessible units available. New and used. CCI/Brian Touey 805-896-3777. (CBM)

PORTABLE RESTROOM TRAILERS

Restroom Trailer - Gold Series: 32', new and used. Women's - 5 stalls, 2 sinks; Men's - 2 stalls, 2 urinals, 2 sinks. CCI/Brian Touey 805-896-3777. (CBM)

Restroom Trailer - Platinum Series: 30', new and used. Women's - 4 stalls, 2 sinks. Men's - 2 stalls, 3 urinals, 2 sinks. CCI/Brian Touey 805-896-3777. (CBM)

PORTABLE RESTROOM TRUCKS

2002 International Pumper Truck: 4700 series, DT466, automatic, air brakes, 1200 gallon waste, 300 gallon fresh water, Masport 75 pump. CCI/Brian Touey 805-896-3777. (CBM)

POSITIONS AVAILABLE

North American Services Group (NASG) is one of the largest and fastest growing privately held industrial cleaning companies in North America. We are searching for experienced supervisors, operators, and laborers for industrial cleaning, water-blasting, vacuum truck services, abrasive blasting, hydro-excavation and plant maintenance for our Salt Lake City, UT and Elko, Nevada expansion. We offer excellent pay, great benefits, including 401K with match, overtime and relocation package for suitable candidates. Please contact Rick Matteson at 800-866-6247. (P3C4)

Industrial Supervisor needed for the East TN-North GA area. Vacuuming and waterblasting experience needed. Familiarity with paper and steel industries a plus. Applicants can call 800-588-3236 or apply with qualifications and salary requirements to IndSupervisor@gmail.com. (C5)

Service Manager: In order to manage our hyper growth, we are looking for an outgoing, unconventional professional. You are a leader and a great coach. You have experience in plumbing and drains. We offer top pay, benefits, relocation expenses. Call Randy 403-648-3871. (C5)

Looking to relocate to Sunny South Florida? Are you an experienced plumber or sewer and drain professional? Then you deserve to earn \$80K/year, \$5,200 bonus and a new truck and full benefits. Please call Don at 1-800-930-1123 or 954-981-2133. (CPBM)

SBP, Inc., a Northwest Florida-based company, is seeking qualified personnel willing to travel. If you are experienced in cured-in-place pipe lining, high pressure cleaning and video and/or manhole or lift station rehabilitation using epoxy lining systems, fax your resume to 850-478-4507 to the attention of Wanda Murphy. (C4)

BUY IT - SELL IT - PLACE IT - www.cleaner.com - AVAILABLE ANYTIME, ANYWHERE, ANY DAY

POSITIONS AVAILABLE

Plumbing company in Florida seeking enthusiastic class B CDL tanker endorsement licensed pump/vac truck operator. Experience preferred. Medical, 401K, holidays, vacations. 1-800-930-1123 or 954-981-2133. (CPBM)

Spartan Tool currently has openings for Territory Managers. The successful Spartan Tool Territory Manager is an honest, self-motivated individual who is willing to get his/her hands dirty, is able to routinely travel all of the territory, resides in or very near a major metropolitan center within the territory, is mechanically adept, is able to lift 75 pounds and is customer-service oriented. Please see www.spartan-tool.com for more information. (CBM)

PRESSURE WASHERS

2 - Sagino high pressure washers with 150 hp electric motor driven, 300 bar/4500 psi Tri-prex pump, ss manifold and fittings, skid mount, insulated sound proof box. \$14,000 each or \$24,000 both. Call 503-969-9557 or 503-682-2723. (C4)

US Jetting, 5000 psi at 9 gpm, 26 hp Deutz, 30 actual hours. One 200' reel and one 100' reel. Can be operated with one gun at 5000 and 9 gpm or two at 5000 and 4.5 gpm. Cost new \$18,000. Offers? 712-527-1440. (C4)

PUMPS-HIGH PRESSURE

Giant MP4130, 2000 psi, 14 gpm, with Kohler 25 hp engine, used 40 hrs. \$2,000. California 209-928-3477. (C4)

PUMPS-SUBMERSIBLE

Wholesaler for Hydromatic, Zoeller, Myers, Liberty and ABS pumps. We also supply Grinder pumps and basins. Will help you size them. Septic Services Inc. 800-536-5564. (CPBM)

PUMPS-VACUUM

Complete line of Moro, Conde and engine-driven, stand-alone pump systems, DC10 washdown pump. Call us for any of your vacuum truck parts from shut-off valves, primary and secondary valves, hoses, vacuum pumps and drive systems. Septic Services Inc. 800-536-5564. (CPBM)

SAFETY EQUIPMENT

Large quantity of Tyvek, Saranex and CPF3 suits, slush boots. Rubber, leather and nitrile gloves. Fittings and tank entry equipment. Retail value over \$300,000. Sale price \$150,000 OBO. Will separate. 716-284-1260 or 716-510-2482. (CP4)

SEPTIC TRUCKS

1999 Peterbilt, 435 hp Cat, 13 spd., with new 3400 gallon vacuum tank, new Moro M10 pump, new paint and tires, exc. shape. \$65,000 OBO. 309-224-8772. (CP7)

2003 International 4400 DT466, 2500 gal. aluminum tank, 350 cfm pump, 65,000 miles. Was Jay's Show Truck. Plus 250' Tiger flex hose. Excellent condition. \$54,500 OBO. Please call Jim @ 312-543-0570. (CPT6)

1993 International FH900 PresVac PV750. Runs great. Steel tank. Picture can be emailed upon request. Call 1-203-838-7000, ask for Bill or Dave. (CP4)

1992 Ford L9000, AC, 3700 gallon tank. Moro M-9 pump, hoisted unit, full opening rear. Good truck for washbay cleaning and septic tanks. \$27,000. 913-631-5201. (P4C5)

2003 Sterling 9513. 430 Mercedes power. Aluminum rims, fuel tank and tool boxes. Custom built unit. 4000 gallon steel vacuum tank. 750 water cooled vacuum pump. 35,000 miles. Mint condition. Always garaged. \$65,000. Call 781-585-1725. (CP4)

SERVICE/REPAIR

www.servicewithasmile.com
Sewer Cam Reel and Camera Repair: Authorized for General Wire, Ratech & Ridgid. Quality service on all brands. Need more info? Give Chuck a call. Electronic Repair Co., Birmingham, AL 35206. 205-836-0454; email: part@servicewithasmile.com. (CBM)

Sewer Cam Reel and Camera Repair: 48-hr. turn-around time. General Wire, Ratech, Electric Eel, Gator Cams. Quality service on all brands. For more info. give Jack a call. Dynamic Cable Repairs, Lodi, NJ 07644. 973-478-0893. (CBM)

SHOWER TRAILERS

Shower Trailer - Gold Series: 32', new and used. Men and women sides each have 3 private shower stalls with changing area, 1 restroom stall, 1 sink. CCI/Brian Touey 805-896-3777. (CBM)

TOOLS

T&T Tools: Probes, Hooks. Probes feature steel shafts with threaded and hardened tips. The insulated **Mighty Probe™** tested to 50,000 volts. **Top Poppers™** open manhole covers easily. Free catalog. www.TandTtools.com. Phone **800-521-6893**. (CPBM)

TV INSPECTION

Cues TV/Grout Truck on 1998 GMC cab-forward diesel with night owl P&T, shorty tractor, 8" and 10" lateral packers, \$38,000. Also 1995 Chevy step-van with Cues TV equipment, night owl P&T, shorty tractor, \$22,000. Call 877-360-0780 or 407-849-1481. (C5)

2001 Chevy Cube Van, white with 48,000 miles, with roof top AC, Aries pan/tilt camera with two tractors, 550' of cable, DVD or VHS. Call 641-660-6991 or 641-673-9377. (P5C6)

1998 GMC Cues TV System: Approx. 1,700 L.F. of multi conductor cable, pan & tilt, Shorty transporter, washdown system, lots of storage. Good condition. Ready to work. Financing available. \$55,000. Kelly 608-279-2299. (CBM)

Buy direct from the factory, Pearpoint used vehicles (utility vans and step vans) with equipment, (optional) software and computers. Equipment has warranty and prices range from \$45k-\$90k. Contact Pearpoint 800-688-8094 x 245 for further details. (CMBM)

New Dealer Demo Unit 1999 Aries Saturn Aries Inspection Camera. Push reel assembly, spare parts kit, 2004 Saturn Aries LED camera, VD1000 data upgrade, push skid assembly. \$12,500. Call 1-800-338-7274 ext 1009. (C4)

Must see! 2 X Envirosight camera systems 2005 pan-and-tilt camera 4X digital zoom Rover 100 steerable crawler 4-12" automatic motorized reel PCU with monitor, text generator, footage counter. Portable or truck installation. Serviced and inspected Envirosight. 613-227-8659. (CP4)

TV INSPECTION

FOR SALE: 2 push camera reels. 1) Cues reel with wheels, counter and over 200' of cable. 2) Original SeeSnake reel with 200' of cable. Both appear new and unused. No camera or monitor. Perfect for backup or replacement. \$1,499 each. Pictures available. Call 1-866-781-9100 or bernie@glueco.net. (C4)

BEST BUY: Must see this 1997 RST video system that includes a P & T, tractor, and an additional main-line camera. Converted ambulance with odometer of 48,000, perfect studio, storage space and safety lights. The software includes printed reports, hard disc, and Sony Photomate. Photos of interior and exterior are available via e-mail. Special Price \$24,000. Call Don at 503-969-9557. (C4)

2007 Envirosight Crawler Rover 125 with everything. Exceptional TV inspection system. Used on one job. Factory warranty. Fits in SUV. One man operation. Excellent condition. Best offer. 916-984-7726. (C5)

Aries TV sewer inspection system, pan & tilt, on tracks, color, in 1993 Ford E350 box van, roof air, 7.3 diesel, 80K miles, Martin diesel generator 7.5 kw, TV, VCR, 3 units available. Call or email for more info and pictures. We can ship to any location. Very nice City owned trucks. Asking \$29,950 ea. Call 573-374-8785 or email elitemotors@charter.net. (CP4)

EASYCAM COLOR CAMERA. FINALLY! A COMMON SENSE APPROACH TO CAMERA DESIGN. EasyCam requires no special monitor, all parts and components are owner-replaceable. With EasyCam, there is no more expensive repair costs, no more lengthy downtime. Built tough to last. 2-year guarantee. (*US & Foreign Patent Pending*) **ONLY \$3,950.00. EASYCAM - "it just makes sense."** www.easycaminc.com; 1-423-349-4300. (CBM)

2003 P-448 PEARPOINT STEERABLE TRACTOR with power scissor lift, 18" to 72" pipe, S/N 448-063. Complete w/accessories. \$25,000 OBO. Dale or Mark 269-381-2400. (CMBM)

Used and rebuilt line locators: Gen-Eye II, Rapid Detection RD-4000, Prototek ARD4, Ferris and LF2100, Ridgid Navitrack. The Cable Center. 800-257-7209. (CBM)

TV INSPECTION

1997 Chevy HiCube Van RST with Buchan grout system, new grout hose, winch, packers 8"-30" running condition. Includes reels, cables, data display, camera controller, generator, printer, monitor, computer with Win Logger hard drive. Camera tractor not included. \$35,000. Call 1-800-664-3937. (CBM)

CYCLOPS CCTV SEWER INSPECTION SYSTEMS. New and refurbished systems in stock ready to go to work. Van and trailer mounted or portable, Cyclops has what you need to start inspecting right away. P&T camera, powered cable rewind, on-screen footage and data, DVD recording, heavy duty transporter, cable lengths to 1000' and one year full factory warranty. Loaner program is available for the life of the system. Deal with the factory not a sales rep. Visit our website @ cycloptv.com or give us a call @ 830-249-9756 and talk to the guys that build 'em. (C4)

Pads and Chain Assemblies: Silicon carbide filled for maximum traction and long life. Single and double hole pads for all makes of tractors. Money back guarantee. Contact **Pipe Tool Specialties** (503) 1-888-390-6794 or fax 1-888-390-6670. Samples sent upon request. Same day shipping. We are a 6/12 company. (CMBM)

REBUILT INSPECTION CAMERAS: Gen Eye I, II, III. For more information call Jack at Dynamic Cable Repairs. 973-478-0893. (CBM)

Used and rebuilt camera kits in stock. Gen-Eye II color and black-white cameras. Push rods 131, 155, 200. Ratech 180. Pearpoint P332 color self-leveling 194. The Cable Center. 800-257-7209. (CBM)

1983 GMC 1-ton with Aries/Cues TV system, pan/tilt/zoom, transporter, ready to work. \$16,000 OBO. Call 262-548-9963. (C4)

1998 Cues TV grout unit, 34,880 miles, color camera, diesel, generator. 972-938-1905. www.empireequip.com. (CPBM)

Wanted: Used tractors, crawlers, straight-pan/tilt cameras, lighthoods, power controls, cables, reels, monitors, software, etc. Working or not. 902-435-8200, fax 902-435-8222. (CBM)

PLACE YOUR AD ONLINE AT www.cleaner.com - IT'S ALWAYS THERE TO MEET YOUR BUSY SCHEDULE

VACUUM LOADERS

1982 Ford Vactor unit, wet-dry, 1976 Hend. V6 Detroit, V4 Detroit, vacuum truck; 1970 Hend. V6 Detroit, V4 Detroit, vacuum truck. All in working condition. 806-273-2865. (P3C4)

1989 series 2000 Vactor vacuum box, excellent condition, auger from bag house, hydraulic boom, photos available upon request. \$5,000. 204-633-4879. (CP5)

WANTED

Wanted to Buy: Vactor 2100's and late model Guzzlers. Cash. 800-336-4369. (CPBM)

WANTED

WANTED: 2505 Terra Gator Tool Bar, 4 or 5 shank, straight bar, model P-16 Case IH reset style. Ph: Ron @ 204-745-8310. (CPT4)

WATERBLASTING

40K, 20K, 10K, 300 HP CAT, HD trailer mounted, guns, hoses, many other access. **Low hours. 720-379-5840.** (CBM)

Sapphire nozzles for all major 40,000 psi waterblasters at wholesale prices! Same-day shipping. UHP replacement parts, hoses. waterjet@bell south.net, 772-286-1218. (CBM)

WATERBLASTING

Water Blasters, new and used, parts and accessories. Safety and supplies. Since 1996. Hablamos Espanol. www.hydroplusinc.com. 562-436-5000. (C6)

Butterworth Model 375 H, 20,000 psi trailer mounted waterblaster. 1523 original hours. Detroit diesel powered with accessories. \$35,000. 716-284-1260 or 716-510-2482. (C4)

1987 NLB 20250, 1989 NLB 20250, 1996 NLB 15600, 1995 NLB 10200, 1987 NLB 10150. Call for pricing and pictures 330-270-9900 ext. 3. (P3C4)

WATERBLASTING

Flexible lancing machine, Freelance MK5 Model #07-95, serial #FL5-1016. Call for information. 330-270-9900 ext. 3. (P3C4)

WATERBLASTING

Water jetting equipment. We rent, sell and repair water blasters. Visit us at: www.waterjettingequipment.com or phone 714-259-7700. (CPBM)

It's **EASY** to submit your classified **ONLINE!** Just go to:

www.cleaner.com

CLASSIFIEDS

Place A Classified Ad

Fill in the **Online Classified Ad Blank!**

MUNICIPAL SEWER WATER	Cleaner Pumper	CLASSIFIED AD FORM	PRO	ONSITE installer	
Please print ad legibly below with <i>correct punctuation and phone number</i> . Circle each word to be bolded, if any. (\$1.00 extra per word)					
CHOOSE THE CATEGORY:					
<input type="checkbox"/> Aerators <input type="checkbox"/> Blowers <input type="checkbox"/> Bucket Machines <input type="checkbox"/> Businesses <input type="checkbox"/> Business Opportunities <input type="checkbox"/> Cable Machines <input type="checkbox"/> Computer Software <input type="checkbox"/> Dewatering <input type="checkbox"/> Drainfield Restoration <input type="checkbox"/> Drain/Sewer Cleaning Equip.	<input type="checkbox"/> Dredges <input type="checkbox"/> Excavating Attachments <input type="checkbox"/> Excavating Equipment <input type="checkbox"/> Hand Tools <input type="checkbox"/> Hazardous Waste Units <input type="checkbox"/> Hydroexcavation <input type="checkbox"/> Jetters-Trailer <input type="checkbox"/> Jetters-Truck <input type="checkbox"/> Jet Vacs <input type="checkbox"/> Lease Financing	<input type="checkbox"/> Levels & Transits <input type="checkbox"/> Locators <input type="checkbox"/> Miscellaneous <input type="checkbox"/> Parts & Components <input type="checkbox"/> Pipeline Rehabilitation <input type="checkbox"/> Portable Toilets <input type="checkbox"/> Portable Toilet Tanks <input type="checkbox"/> Portable Toilet Trailers <input type="checkbox"/> Portable Toilet Trucks <input type="checkbox"/> Positions Available	<input type="checkbox"/> Positions Wanted <input type="checkbox"/> Pressure Washers <input type="checkbox"/> Pumps-Dredge <input type="checkbox"/> Pumps-High Pressure <input type="checkbox"/> Pumps-Submersible <input type="checkbox"/> Pumps-Vacuum <input type="checkbox"/> Pumps - Washdown <input type="checkbox"/> Pumps-Water <input type="checkbox"/> Rodding Machines <input type="checkbox"/> Roll-Off Containers	<input type="checkbox"/> Root Control <input type="checkbox"/> Safety Equipment <input type="checkbox"/> Septic System Components <input type="checkbox"/> Septic Tanks <input type="checkbox"/> Septic Trucks <input type="checkbox"/> Service/Repair <input type="checkbox"/> Slide-In Units <input type="checkbox"/> Sludge Applicators <input type="checkbox"/> Tanks <input type="checkbox"/> Tools	<input type="checkbox"/> Trailers-Vacuum/Tanker <input type="checkbox"/> Trucks (dump/septic/misc.) <input type="checkbox"/> TV Inspection <input type="checkbox"/> Vacuum Loaders <input type="checkbox"/> Vanes <input type="checkbox"/> Vehicle Tracking <input type="checkbox"/> Wanted <input type="checkbox"/> Wastewater Transfer <input type="checkbox"/> Waterblasting
CHOOSE THE PUBLICATION(S): (Deadlines are for the month preceding issue)			CLASSIFIED AD RATE:		
<input type="checkbox"/> CLEANER Deadline: 1st of the Month	<input type="checkbox"/> PUMPER Deadline: 10th of the Month	<input type="checkbox"/> PRO Deadline: 17th of the Month	\$1.00 per word, per month, with a 20-word minimum or \$20. [\$1.00 extra per bold word (key words only)]		
<input type="checkbox"/> MUNICIPAL SEWER & WATER Deadline: 1st of the Month	<input type="checkbox"/> ONSITE INSTALLER Deadline: 17th of the Month		ADVANCE PAYMENT REQUIRED: No billing for classified ads. Payment must be received in advance before publishing.		
CALCULATE THE AMOUNT DUE:					
_____ words X \$1.00 = _____ X _____ Publications X _____ Months = \$ _____			(Example: 25-wd. ad x \$1.00 per word = \$25.00; \$25.00 x 2 publications [Pumper & Pro] = \$50.00; \$50.00 x 2 months to run the ad = \$100.00 Total)		
(\$20 minimum) # of publications checked above # of months to run the ad Total Amount Due					
FILL IN COMPANY AND PAYMENT INFO:			MAIL this completed form with payment to: COLE Publishing Inc., PO Box 220, Three Lakes, WI 54562		
COMPANY NAME: _____			FAX this completed form to: 715-546-3786		
ADDRESS: _____ PHONE: _____			ONLINE forms at: www.cleaner.com www.pumper.com www.promonthly.com www.onsiteinstaller.com www.mswmag.com		
CITY: _____ STATE: _____ ZIP: _____			QUESTIONS: CALL 1-800-257-7222		
PLEASE FILL OUT CREDIT CARD INFORMATION COMPLETELY INCLUDING V-CODE (3-DIGIT NUMBER FOUND BY YOUR SIGNATURE)					
CREDIT CARD NO.: _____		V-CODE: _____		EXP. DATE: _____	
CARDHOLDER NAME: _____		PHONE: _____			
WE ACCEPT: 					

Deep Reconnaissance

A pipe inspection camera does duty in the follow-up to a mine disaster

By Scottie Dayton

The collapse of the Crandall Canyon Mine in Utah last August killed six miners, then three rescue workers. The intense pressure on the coal pillars supporting the mine caused them to burst, sending coal and rock flying with explosive force.

After rescuers sent drop cameras down bore holes, they wanted a better view of the mine shaft. Inuktun Services Ltd. in Nanaimo, B.C., was contacted to build a robot that could descend more than a mile through 9-inch-diameter holes and crawl 300 feet.

Mechanical engineer Jeff Stanway and team designed a 19.5- by 8-inch chassis based on the Versatrax 150 crawler from Inuktun. They mounted an articulated arm with pan-and-tilt Spectrum 90 camera out the rear to



maintain a low profile. A Crystal Cam camera at the front monitored descent and landing. A 14.5-inch tether-control arm at the rear held the cable out of the way when the 70-pound robot reversed.

"Our control system for these components goes 1,500 feet, so we partnered with Ken Peligrin of PipeEye International in Las Vegas," says Stanway. Besides field experts, Peligrin supplied a 6,000-foot, fiber-



Only a 5/8-inch clearance separated the camera robot from the bore hole walls. Above (inset), a Crystal Cam camera illuminates the front of the robot, while an articulated arm with pan-and-tilt Spectrum 90 camera is mounted at the rear of the modified Versatrax 150 pipe inspection crawler.

optic tether with telemetry canister. Stanway connected it to 300 feet of soft tether attached to the robot.

On the first day, the clutch on the winch failed, and the robot free-fell until the camera jammed in the bore hole. Stanway repaired the soft tether and winch that night.

The robot was 10 feet from the bottom on the second day when shifting ground changed the channel to an impassible oval. "Rescuers had sent a drop camera down the hole, so this information was a bonus," says Stanway.

Lowered into a different hole on the third day, the robot landed in

front of a small mud pyramid. Two feet of coal, blown from the walls by the pressure of the mine collapsing, littered the floor. "The robot's 4-inch-high tracks weren't enough to navigate over the debris," says Stanway. "Then mud fell on the lens, and even with groundwater flowing past, we couldn't wash it off." This information also was important.

On the fourth day, the bore hole collapsed, burying the robot. "The experience was sobering. Anything put into that mountain, it took," says Stanway. ■

LAPLACE EQUIPMENT

RENTALS, SALES & SERVICE

- **WATERBLASTERS:**
PRESSURE TO 40K,
FLOW TO 100 GPM
- WATER JETTING TOOLS
- HYDRO-MOWERS
- 3D NOZZLES
- ROTATING NOZZLES
- HIGH PRESSURE HOSES
- LANCES
- FITTINGS
- TIPS
- SUPPLIES
- EXPERIENCED TEAM
FOR PLANNING,
TRAINING & SETUP



Thank you for visiting us

CALL
985.652.5210
FOR YOUR
WATERBLAST
PROJECT
SOLUTIONS
WWW.H2OBLAST.COM



Get a Life!

...with software that will give you your life back!

Summit™ XP Service Profit Builder™

Customer & Job Tracking
Reminders & Repeat Jobs
Dispatching & Mapping
Parts Inventory
QuickBooks® Link
...and much more!

DEMOS ONLINE!

Demo DVD/CD also available

Ask about our other software programs for:

- Portable restroom & other rental businesses
- Sales Contacts • Incentives
- Fleet Maintenance (Vehicles/Equipment)

Easiest to use!

...Over 25 years experience

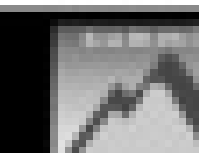

Ritam Technologies, LP

Sales: 800-662-8471 Email: info@ritam.com Web: www.ritam.com

PROBLEMS FINDING LEAKS?

In Sewer Systems...

...In Plumbing Systems



Not anymore with the world's most complete smoketesting systems.

Original RipCord Smoker™ Features:

- More minutes of smoke flow per gallon than any competitive model.
- LiquiSmoke smoke fluid is the safest and cleanest way to test sewer lines.
- Most complete public service announcement kit and data collection software.



RIPCORD Smoker™

LiquiSmoke™

- Laboratory tested safe, does not contain toxic compounds like "zinc chloride".
- Won't stain or leave odors.
- One gallon will last up to 3 hours.



Thanks for visiting us!

HURCO
TECHNOLOGIES, INC.

Power Smoker 2™

- Plumbers—finds leaks and odor problems in plumbing systems fast and economically.
- Contractors—avoid costly ripouts. Find the leak before the job is done.

SuperJet™

- High Performance Smoke Generating Systems
- Standard on all HURCO "Smoker" systems
- Patented design creates 3 times more minutes of smoke than competitive models.
- Super efficient. Atomizes LiquiSmoke™ resulting in a nearly 100% burn.



PowerSmoker 2™

For a video demonstration and complete laboratory test results of HURCO's Smoketesting Systems go to www.GetHURCO.com.

See how it works at
Get HURCO.com
or call
1-800-888-1436

Beside the Road

Horizontal directional drilling and special pipe enable installation of a new water main along a busy highway while keeping traffic flowing to businesses

By Scottie Dayton

Widening busy Ohio Route 170 to five lanes through the township of Calcutta involved moving utilities 15 feet beyond the path of two eastbound and three westbound lanes. Four major shopping plazas, several retail stores and restaurants line Dresden Avenue, serving shoppers from parts of Pennsylvania, West Virginia and Ohio.

The Ohio Department of Transportation District 11 stipulated that at least one traffic lane always remain open in each direction to minimize business disruption. So Bert Dawson, P.E., Columbiana County engineer, specified horizontal directional drilling under driveways and parking lots, and trench cutting in open areas.

Dave Sugar of Dave Sugar Excavating Inc. in Petersburg, contractor for the county, subcontracted Chuck Kirk of Kirk Excavating in Columbus to help install the new 12-inch potable water main. Kirk focused on the directional drilling portion. A restrained joint PVC pipe with fittings that matched the city's 12-inch water mains became the key to an efficient job with little disturbance to the merchants.

"It took one day to bore through the shale, but we were well ahead of our completion deadline. It was more of an annoyance than a worry."

Chuck Kirk

Strong and rigid

Communicating with other contractors was critical. "As one of the last companies onsite, we had to be certain that everyone else finished their work before we started," says Kirk. "For example, the telephone poles had to be moved and the road paved before we arrived." The water



Assembly of a long run of Certa-Lok C900/RJ restrained joint PVC pipe was the exception. The 20-foot lengths were usually joined as they were pulled into the entrance pit.

main and gas line were relocated simultaneously.

The plans showed Kirk's men where to directional bore, and the stations were marked with stakes. Occasionally, one of them had to pothole using a shovel to find gas and telephone lines. "Most directional drilling was beneath driveways," says Kirk. "Whenever we hit an open area, we dug." Sugar's crew set up construction barrels and controlled traffic.

The pits, excavated in mostly clay with a John Deere backhoe, were 22 feet long by 8 feet deep by 4 feet wide to accommodate Kundel trench boxes. The PVC pipe — 1,670 feet of Certa-Lok C900/RJ with cast-iron O.D.s and 280 feet of Certa-Lok Yelomine from CertainTeed Corp. — was installed 6 to 9 feet deep, depending on the depth of utilities.

Dawson chose C900/RJ because it meets all performance requirements of AWWA C900 and eliminates concrete thrust blocks in properly engineered water systems. "PVC is

two and a half times stronger than HDPE, and is extruded with a thinner wall for a larger I.D. to maximize flow performance," he says. "The pipe also doesn't stretch during installation, then pull out of the couplings when shrinking back."

Other advantages were that the pipe did not require pre-fusing or heat-welding equipment. "Assembling the whole run was the exception," says Kirk. "Most often, we joined the 20-foot lengths as they were pulled into the hole."

Pipe and couplings have precision-machined grooves that, when aligned, lock together with an inserted nylon spline to form a circumferential restrained joint. Teflon-coated elastomeric O-rings in the couplings provide a reliable hydraulic pressure seal.

Down the hatch

One man ran the Ditch Witch JT4020 Mach 1 directional drilling machine while the other used a sonde to locate the boring head or clean up the mud with an HXX

TOUGH JOB

PROJECT:

Move 1,950 feet of water main and sewer 15 feet without disrupting traffic flow to businesses

CUSTOMER:

Engineering Office,
Columbiana County, Ohio.

CONTRACTOR:

Dave Sugar Excavating Inc.,
Petersburg, Ohio.

SUBCONTRACTOR:

Kirk Excavating, Columbus, Ohio

EQUIPMENT:

Certa-Lok C900/RJ and Yelomine pipe, CertainTeed Corp.; Valley Forge, Pa.; JT4020 Mach 1 directional drilling machine, Ditch Witch, Perry, Okla.; D36x50 Series II Navigator from Vermeer Mfg. Co., Pella, Iowa; 4-inch Aggressive Incredibit, Railhead Underground Products LLC, Weatherford, Texas

RESULTS:

New pipes installed with minimal disruption to businesses

Prodigy HydroExcavator from Vactor Manufacturing.

Boring through the clay was uneventful until the duo struck a horizontal layer of shale 400 feet long. Kirk brought his D36x50 Series II Navigator from Vermeer Mfg. and armed it with a 4-inch Aggressive Incredibit from Railhead Underground Products LLC. The drill head withstood the challenge, but a worn, 15-foot rod broke on the boring machine, setting progress back half a day.

The broken rod was removed, the remaining rods re-hooked, and the pull continued. While boring between two newly set telephone poles, one began to lean. Work stopped immediately and the utility company was notified. A crew arrived with a boom truck and held onto the pole as the Ditch Witch operator finished pulling back the reamer, then the pipe. Once the latter was in place, the telephone pole was stabilized.

It took six pulls of 280 to 450 feet to install the C900/RJ. Dave Sugar used standard waterline fittings to connect the new pipe to the city's water works. The 260 feet of 8-inch

Class 200 Certa-Lok Yelomine pipe for the sewer was installed in one pull using horizontal directional drilling and trench cutting. The SDR 17 pipe, which ran through an area with fewer driveways and parking lots, is rated for 160 psi.

Motorists continued their east and west journeys through Calcutta more slowly than usual but could always reach the stores and restaurants. Few realized that trenchless technology and restrained joint PVC piping had made it possible. ■

MORE INFO:

CertainTeed Corp.
800/233-8990
www.certainteeted.com

Ditch Witch
800/654-6481
www.ditchwitch.com

Kundel
877/586-3353
www.kundel.com

Railhead Underground Products LLC
888/313-7455
www.railhead.com

Vermeer Manufacturing Co.
888/837-6337
www.vermeer.com



Scott Heston of Kirk Excavating operates a Ditch Witch JT4020 Mach 1 directional drilling machine while co-worker Casey Applegate uses a sonde to locate the boring head.



The directional drilling machine bores through clay while traffic on Ohio Route 170 (Dresden Avenue) continues unimpeded.

COBRA
SEWER CLEANING HOSE



Bringing together 25 years of U.S. and European engineering/manufacturing technology.

COBRA Sewer Cleaning hose by **Poly-Flow** is engineered and manufactured to handle the toughest and most harsh conditions found in high-pressure sewer cleaning and jetting applications. **COBRA** features a tough polyether-urethane cover that offers maximum resistance to cutting, abrasion, various chemicals, and fungus. Cover colors conform to industry standards for maximum operating pressure ratings. For safety assurance, Cobra sewer cleaning hose is factory tested and sold as assemblies only.

To locate your nearest distributor contact us.....

(503) 493-0015

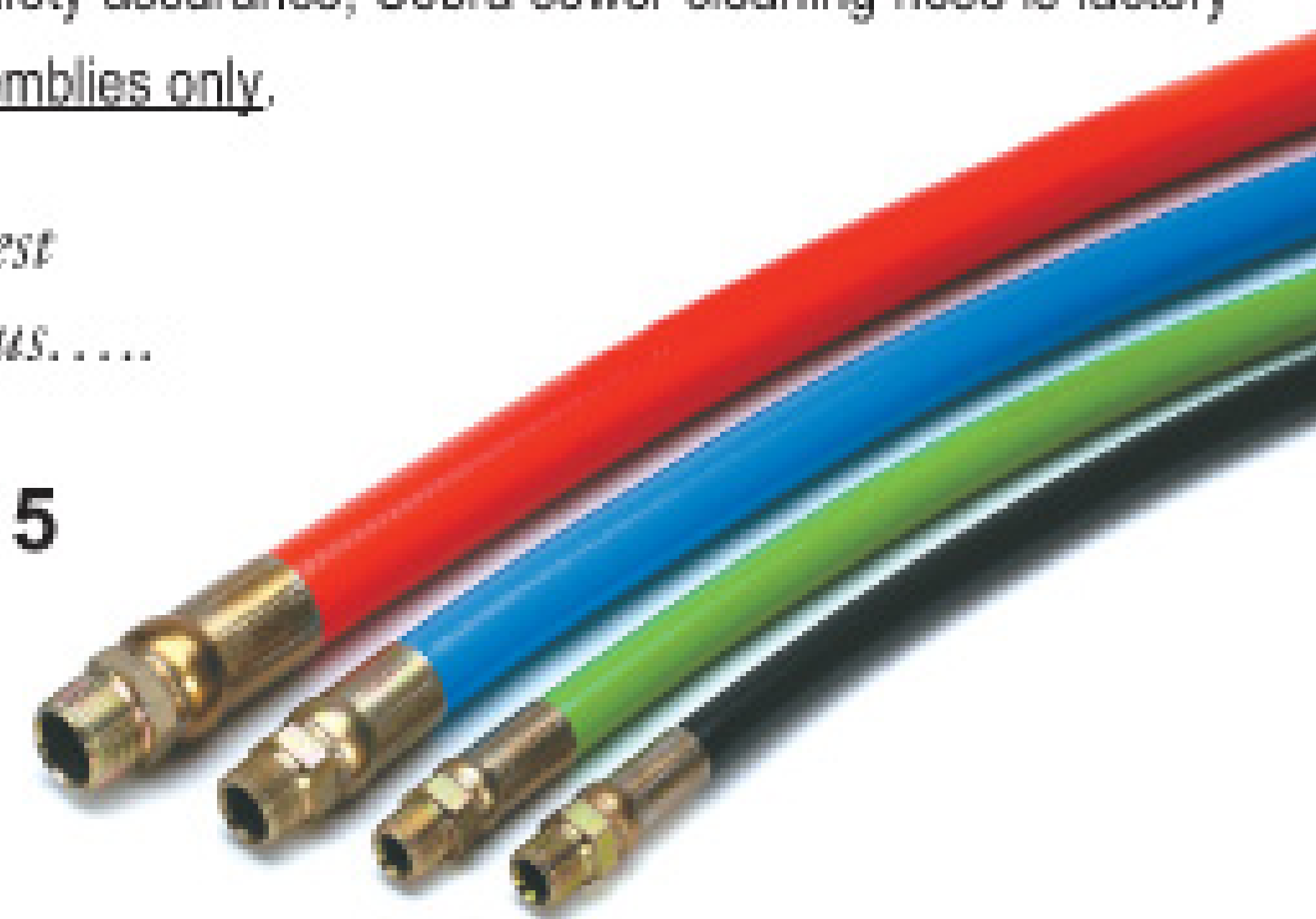

All Cobra products are manufactured in accordance with WASTEC specifications.

We'll Help You Grow!



The Raider

From Ridgid



Warthog

Plumber's Mate

From StoneAge

From Ratech

We carry the best tools available at great prices!

Call for more information.

800.992.0222

Order online 24/7 - www.advancedworld.com



Waterblaster Rentals

- 170 hp - 300 hp units available
- Convertible from 10k to 20k to 40k PSI pressures
- Two convenient locations
- Parts and accessories also available
- Pickup or delivered
- Operator training
- Rent to own

We've got you covered



West Coast (Long Beach, CA)
1-866-515-9891
Midwest (Toledo, OH)
1-888-415-RENT (7368)

www.fssolutionsgroup.com • rentalsfssolutionsgr@federalsignal.com

Industry

NEWS

Federal Signal Opens Long Beach Solutions Center

Federal Signal Environmental Solutions Group has opened its fifth FS Solutions center. The Long Beach, Calif., center will stock high-performance parts and accessories for the company's Guzzler, Vactor and Jetstream brands, as well as other makes and models of waterblasters and vacuum loaders.



Router-Man Ranked Among Top 500 Franchises

Router-Man has been ranked 113 among the top 500 franchises by *Entrepreneur* magazine, and No. 1 in the plumbing category. Rankings are determined by cumulative scores in financial strength, stability, number of franchises, growth rate, years of operation, startup costs and company-provided financing.

USB-Duesen Receives ISO 9001:2000 Certification

Effective December 2007, USB-Duesen, parent company of USB-Sewer Equipment Corp., has been awarded the DIN EN ISO 9001:2000 certificate by the Bureau Veritas.



Brian Metcalf

Earth Tool Promotes Metcalf to CEO

Brian Metcalf has been promoted to chief executive officer for Earth Tool Co., manufacturer of HammerHead products. Metcalf had been vice president of international sales and business development. He holds a degree in accounting from Drake University.

RIDGID Presents Video Contest

RIDGID is celebrating the launch of its new membership site (www.teamridgid.com) with a video contest, "How I Build my Reputation with RIDGID Tools." TeamRIDGID members are invited to record and post an original 1- to 3-minute video illustrating how they built their reputation. The contest ends April 30. Five finalists will receive an all-expense-paid trip to Cleveland, Ohio, to tour the RIDGID headquarters, while the grand prize winner will receive \$2,500 in RIDGID tools.

StoneAge Releases Warthog Catalog

The 16-page Warthog catalog from StoneAge Inc. is available in PDF format at www.stoneage.com/infocenter/index.html. The catalog includes jetting charts, tool breakdowns with each part identified, service kit components and available accessories. ■

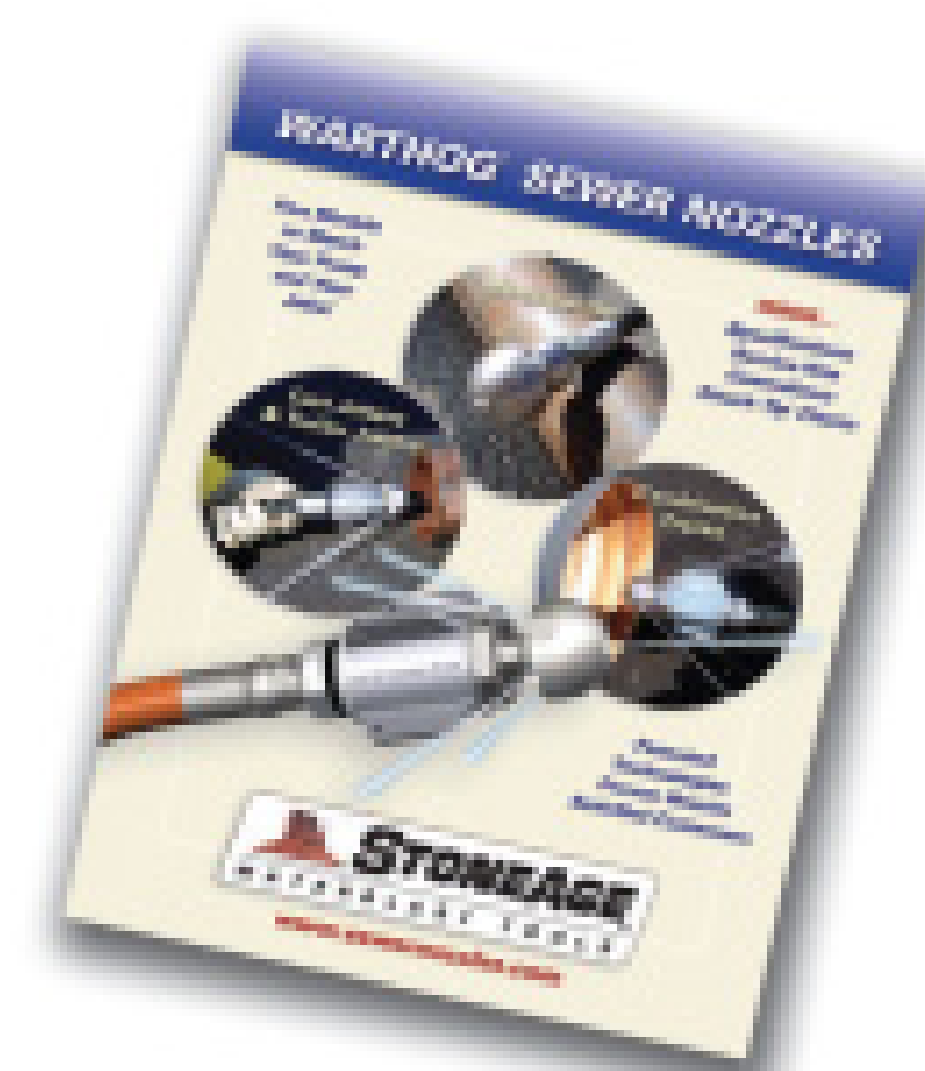

WESTERN SALES, LLC

WATER & WASTEWATER SOLUTIONS

Milwaukee Pump



The Vactor® Pump is designed for sewer cleaning applications which allow this pump to deliver maximum continuous flow at 3000 PSI with minimal wear.



The DP Series Plunger Pump adds a new dimension of rugged strength and versatility for any demanding job.



The D65-20 High Pressure Reciprocating Pump is a high-volume, high pressure piston pump that can't be beat for sewer cleaning applications.

UEMSI

CALL US TODAY WESTERN SALES, LLC

866-493-3406

711 Mission Avenue, Suite 303 • Oceanside, CA 92054
Fax: 760-754-4915 • Email: westernsales@cox.net

THE LEADER IN PUMPER/CLEANER REELS SINCE 1933

Hannay Reels
The reel leader.

Washdown and Clean Up With Hannay Reels

Applications

- Power washing
- High pressure washing
- Vehicle and equipment washdown and clean up

Advantages

- Flexibility of mounted and portable designs
- Hose pickup and storage is quick and neat
- Tried and tested technology
- Tough reels for the toughest environments

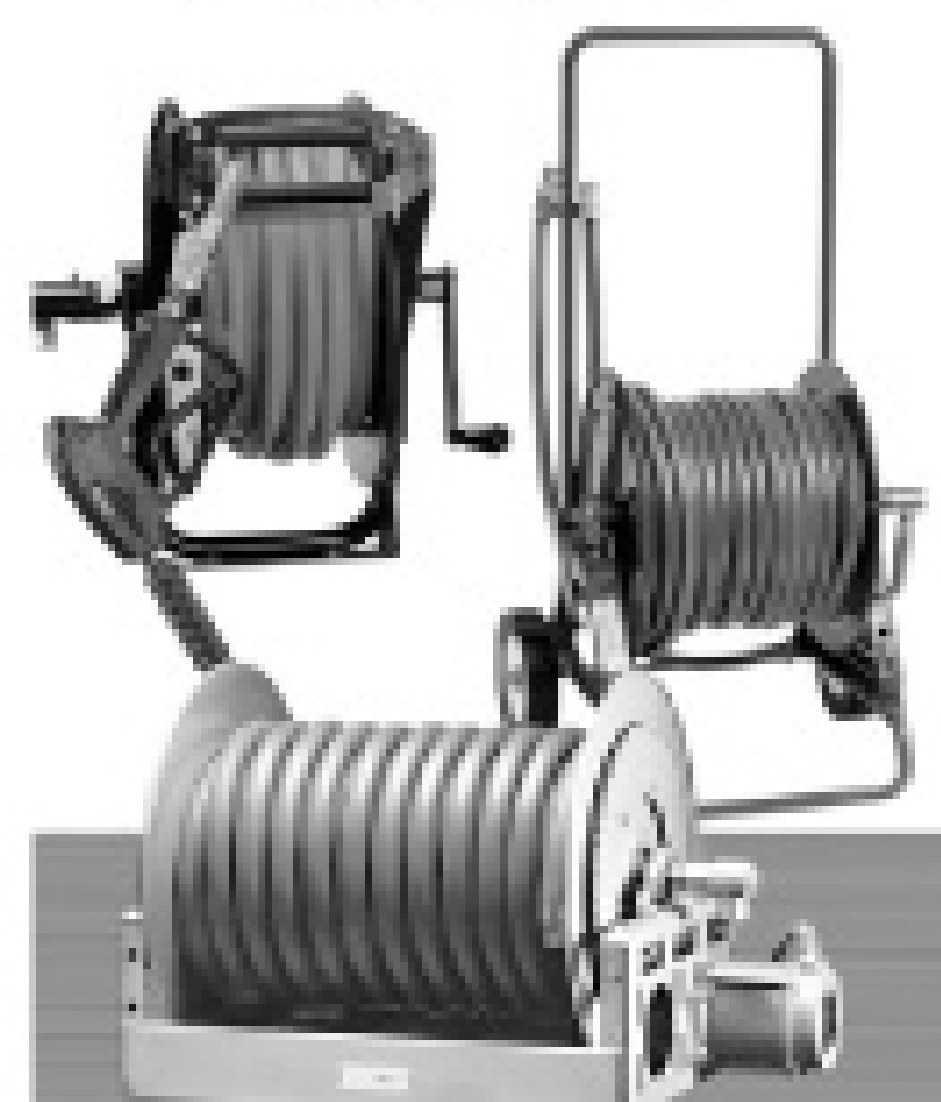

Download or call for your FREE catalog
[http://go.hannay.com/\\$15](http://go.hannay.com/$15) 877-467-3357

**HIGH PRESSURE
WATER JETTERS**

**TRENCHLESS
SYSTEMS**

**CABLE DRAIN
CLEANERS**

Model GO 3500



Wire Rope System



Model GO 68HD

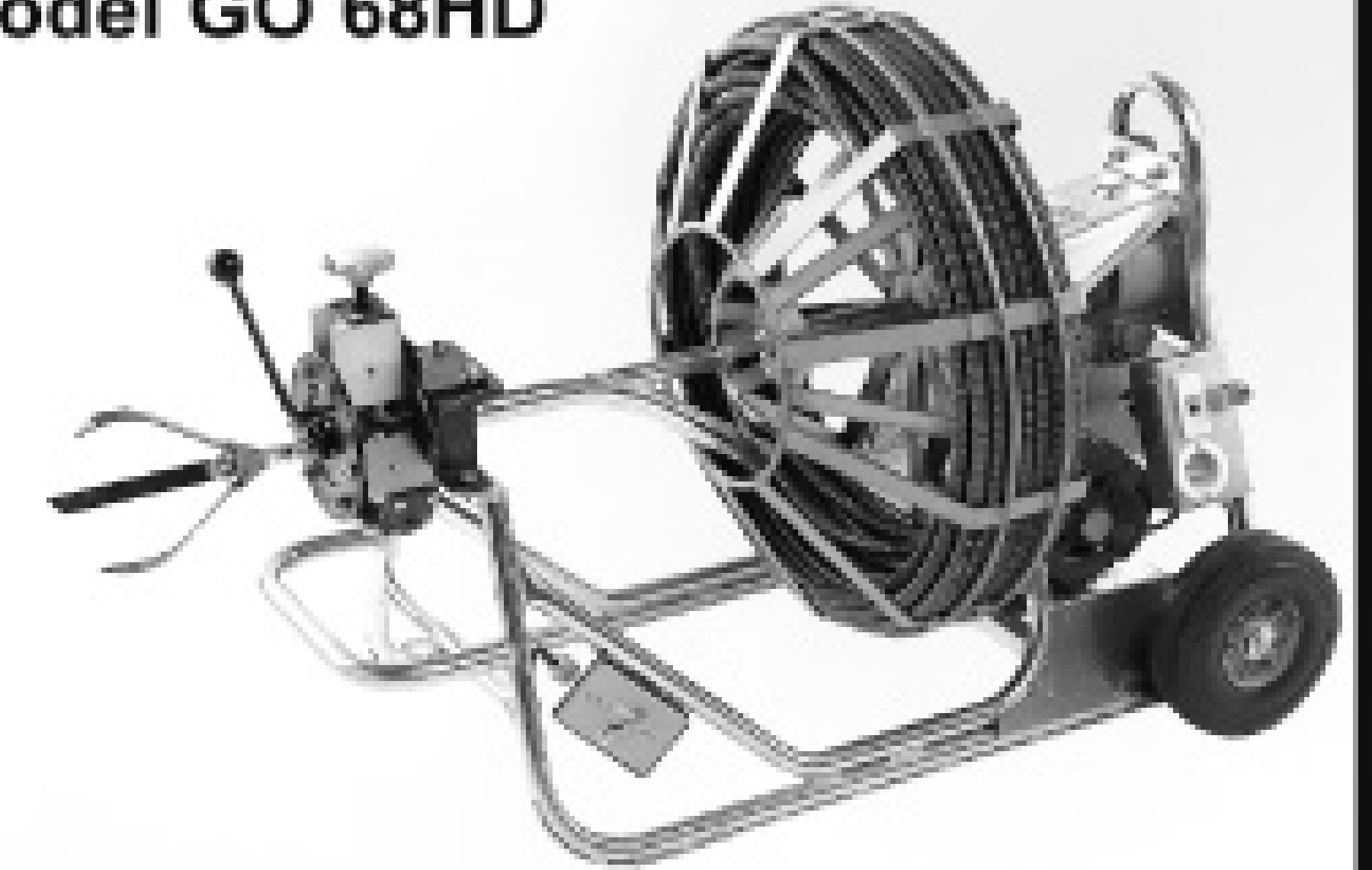

Model GO 50

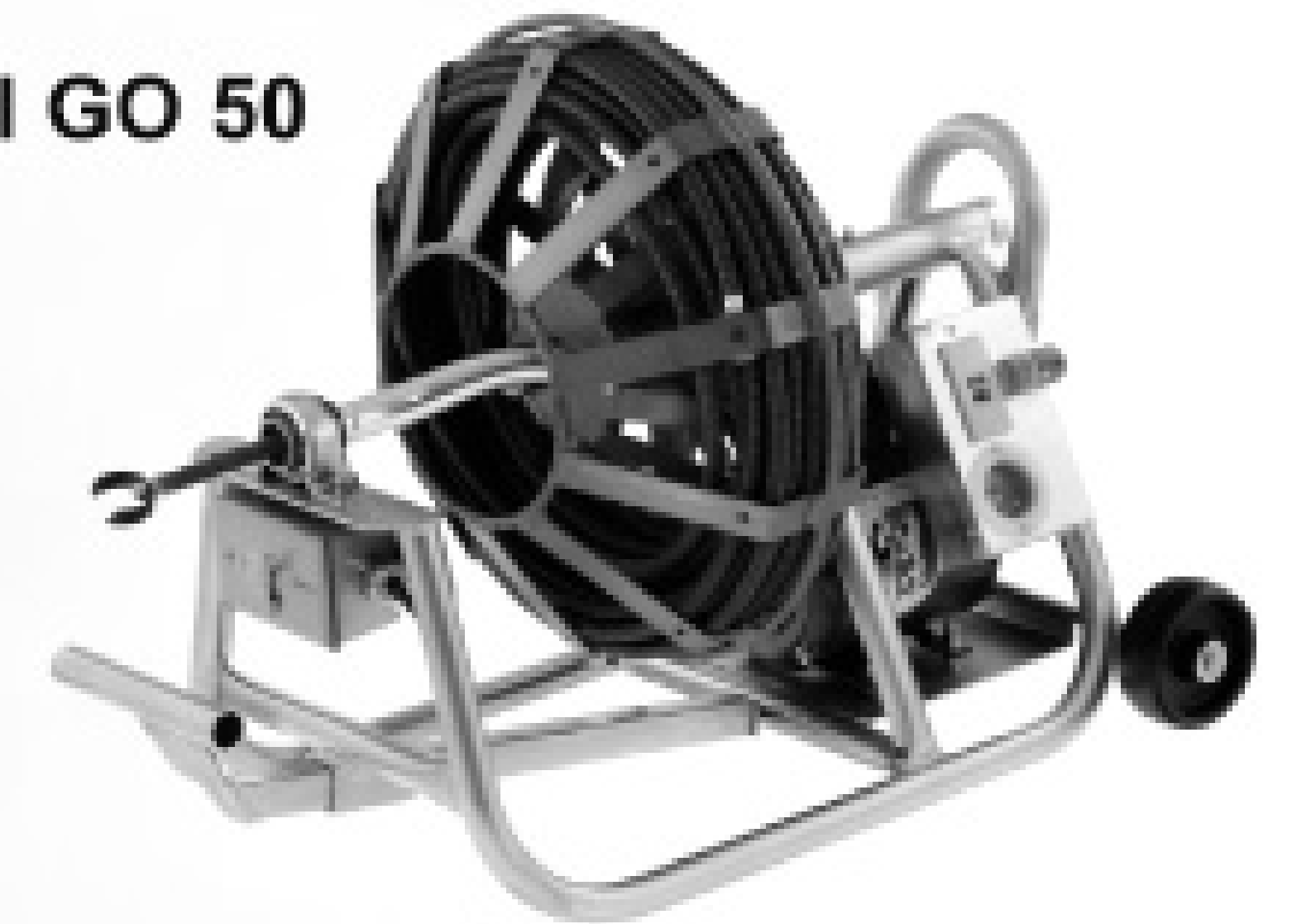

Model GO 1500



Thanks for visiting us!

**WATER
GAS
SEWER**

**PIPE REPLACEMENT
MADE EASY!**

Model GO 380



Model GO 1500A



Model GO 15



Chain System



Model GO 40



GORLITZ SEWER & DRAIN INC.

10132 NORWALK BLVD.
SANTA FE SPRINGS CA 90670

TEL (562) 944-3060

FAX (562) 944-7630

WEB: [HTTP://WWW.GORLITZ.COM](http://www.gorlitz.com)
EMAIL: GORLITZ@IX.NETCOM.COM

STOP!

DON'T ORDER ANY MORE BIOPRODUCTS UNTIL YOU FIND OUT ABOUT BioOne®'s REVOLUTIONARY TECHNOLOGY.

Drain Line, Grease Trap, Septic System Maintenance.
Profitable, Easy to Sell, Simple to Use.
There's nothing else like it.
Professional strength, EPA-recognized BioOne®.

CALL FOR A FREE SAMPLE

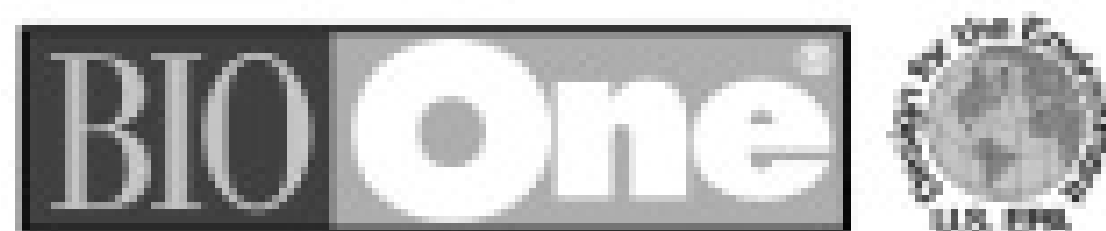

800-951-4246

One Biotechnology • www.1biotechnology.com

1-800-333-9274
www.Jettersonline.com

Pressure Washers

HONDA @ 2700PSI \$377
HONDA @ 3000PSI \$416
HONDA @ 4000PSI \$859

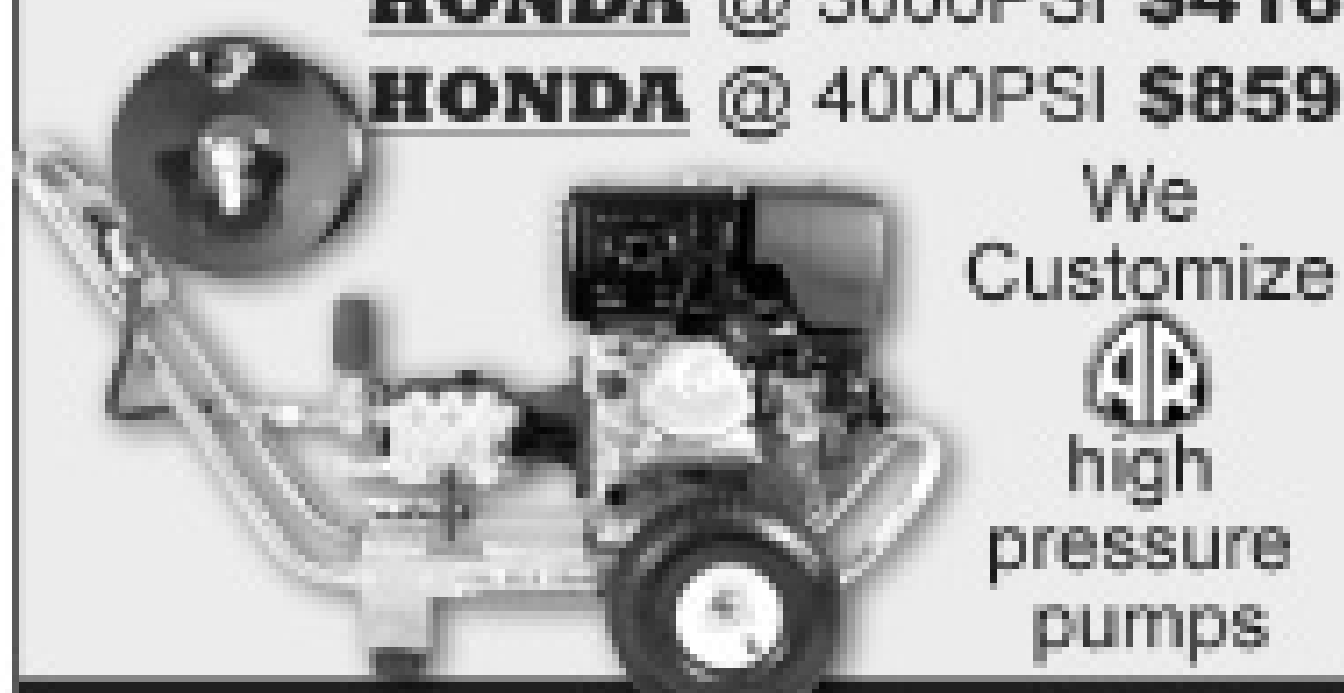

We Customize
4A
high pressure pumps

Honda Engines



5Hp GC **\$199**
6.5Hp GX **\$349**
8Hp GX **\$459**
9Hp GX **\$489**
18Hp GX **\$1,099**

BEST Sellers ALWAYS on Sale

5.6GPM @ 4000PSI **\$399**
8.0GPM @ 3500PSI **\$499**
7.0GPM @ 5000PSI **\$599**



Call For Free Quotation.
We Also Stock Pumps With Left Hand Drive,
Tapered Shaft, Car Wash Duty,
316 Stainless Steel and Unique Applications
1-800-964-9274

Water Cannon - 5 Offices Nationwide,
Since 1981

Pipe Survey Software Solutions

NASSCO Certified

Works with any CCTV inspection system

Easily share your survey data with others

flexidata

CAPTURE. ANALYZE. COLLABORATE.

MUNIXS

RACP SURVEY SOFTWARE

Call today to schedule an online demonstration.

866.299.3150
www.flexi-data.com
www.munixs.com

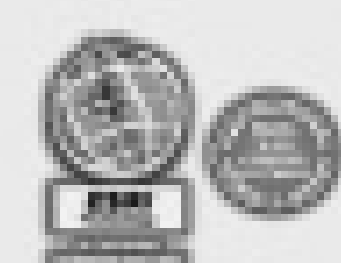

DYE TRACERS

Solutions for:

- Infiltration
- Septic Systems
- Cross Connection
- Leaks and more...



BRIGHT DYES

Division of Kingscoke Chemicals

www.brightdyes.com • FAX: 937-886-9300



FREE SAMPLE 1-800-394-0678

SEWER CAMERAS DUCT & CHIMNEY CAMERAS HYDRO-JETTERS

Sameday & Overnight Shipping Available
1 Year Warranty

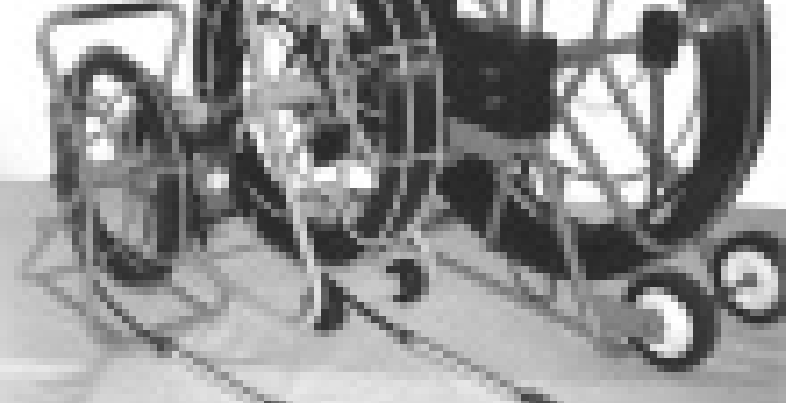

- Affordable Sewer, Chimney & Duct Cameras
- Lengths From 30' to 400'
- 16 Models to Choose From
- We Make it Simple

120' Color Camera Complete System w/Color Monitor/VCR \$2499

Prices Start at \$1349

800-688-0081
www.southcoastequipment.com

10K, 20K & 36K RENTAL FLEET

Flows to 120 GPM
Up to 500 HP



TRY BEFORE YOU BUY!

Waterblasters and engineered accessories.
Rental offices in TX, FL, CA & OH.
Everything to meet your cleaning needs!

GD GARDNER DENVER WATER JETTING SYSTEMS, INC.
CALL TOLL FREE
800-231-3628

NEW IN TRENCHLESS TECHNOLOGY!

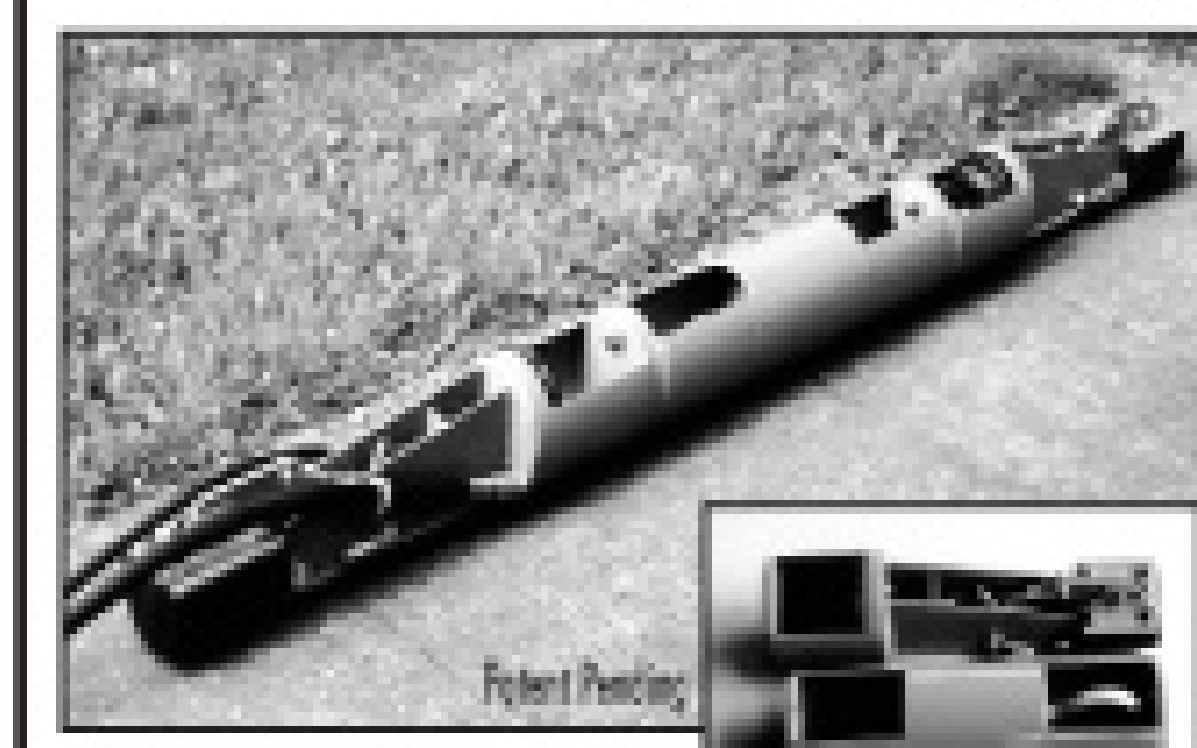

ACP Sag Correction System

- Remove low spots from PVC sewer lines using pneumatic powered vibration.
- No excavation required. Machine assembles in manhole.
- For Pipes 8 inch and larger.
- Can remove sags of any length.

— Advanced Construction Products —
Toll free 866.359.4670 | www.rerounders.com

DYNAMIC CABLE REPAIR

We Repair:
Gen-Eye I, II, III, GL, Electric Eel,
GatorCams, Ratch,
Vision Intruders,
Inspection Cameras, Locators,
Command Modules and Cables

48-Hr. Turn Around Time
INSPECTION CAMERAS ARE OUR ONLY BUSINESS!

973-478-0893

DYNAMIC REPAIRS
40 Arnot St., Unit 20 • Lodi, NJ 07644

HOSE WAREHOUSE

A DIVISION OF UEMSI

Call for pricing and availability on
Thermoplastic Sewer Cleaning Hose,
Hose fittings and TigerTail™ Suction Hose



We Accept **1.800.666.0766**
W137N5560 Williams Place
Menomonee Falls, WI 53051

WARNING Don't Miss Out!

Get your

FREE
issue of
Municipal Sewer & Water.

Cole Publishing
www.mswmag.com
1.800.257.7222

Need An E-commerce Site?

- Competitive Rates
- Fast Service

For information call **COLE Publishing**
at **1.800.257.7222**

Call today to get your Shopping Cart rolling

THE BIG SHO
Underground Piercing Tools!

- Ideal for water, gas, and cable installations
- Available in 2", 2.5", 3" and 4" diameters
- Full line of Accessories Available

Industry Leading **2 Yr. Warranty!**

For More Information Call
1-888-737-3668

For Full Product Line Visit
www.footagetools.com

Footage TOOLS INC.

T&T TOOLS T&T Tools
800-521-6893
 800-521-3260 FAX
 E-mail sales@tandttools.com • www.tandttools.com

Mighty Probe™	Handy Hook™
Sludge Hoe™	Water Probe
(insulated)	Curved Spud™
Sludge Spud™	Top Popper™
Manhole Hook	Ground Buster™
Tommy Hook™	Smart Stick™
Striking Head™	(standard)

www.tandttools.com

PIRANHA HOSE PRODUCTS

- PIRANHA® JETTER HOSE
- STAINLESS NOZZLE TIPS
- SEWER HOSE GUIDES
- SWIVELS & ADAPTERS

ONE CALL AWAY...

CAPITAL RUBBER CORP
(800) 258-3000

WWW.CAPITALRUBBERCORP.COM

CONFINED SPACE ENTRY PACKAGE
ONLY \$3,295

The best package on the market includes:

- 4-Gas Air Monitor (3 Year Sensor Warranty)
- 7' Tripod
- 3-Way Fall Protection
- Work Winch
- Full Body Harness

Add a Blower with 15' of duct for only \$ 300!

Other Equipment Available

- Sewer Maintenance Tools
- Magnetic Lid Lifters
- Camera Systems
- Smoke & Dye Testing Items
- Blowers / Ventilators
- Vacuum Pumps and Acc.
- Aluminum Folding Ladders
- PPE
- High Pressure Water Jetters

MTECH 800.362.0240
www.mtechcompany.com

ERICKSON Tank & Pump

WE TAKE TRADES

509.785.2955

CALL FOR UPDATED LIST OF USED EQUIPMENT

Masport®

PUMPS & QUALITY COMPONENTS

800 Rd. P5 S.W. / Quincy, WA 98848
 fax: 509.785.3770
 e-mail: sales@ericksontank.com
 "TANKS" FOR YOUR BUSINESS!

Jetter Hose

Parker/Dayco-Piranha-Aeroquip

- 1/8" - 3000, 4800 psi
- 1/4" - 3000, 4400, 5000, 10,000 psi
- 3/8" - 3600, 4000, 5000 psi
- 1/2" - 3500, 4000, 5000 psi
- 5/8" - 4000 psi
- 3/4" - 2500, 3000 psi
- 1"-1-1/4" - 2000, 2500, 3000 psi

Call for Price & Delivery

Nozzles, Root Cutters, Clamps, Swivel Joints, Ball Valves, Hose Guides, etc.

Call for Catalog & Prices
Cloverleaf TOOL CO. 800.365.6583

www.cloverleaftool.com

90 DAY JETTER TRIAL

Plumbers - Let us improve your bottom line

13HP 4000 PSI \$1,949
 Free Freight

COMPLETE DETAILS AT
www.amazingmachinery.com

1-800-504-7435

WATER JETS FOR RENT

- Units from 4,000 to 40,000 psi, including convertibles
- 60-600 hp, diesel or electric
- Rent, buy or lease
- Branches in MI, TX, NJ, CA, LA

NLB Corp. 1-877-NLB-7996
www.nlbcorp.com

Running Out Of Time?

Let us build your web site using **OUR time, not yours.**

Cole Publishing
www.colepublishing.com/web
1.800.257.7222

Come In We're

NEEPO

www.onsiteinstaller.com

29th Annual

PUMPER & CLEANER INTERNATIONAL ENVIRONMENTAL EXPO

February 25-28, 2009

Kentucky Exposition Center

One Complete Package

cleaner.com	constructionguide.net
promonthly.com	pumpershow.com
mswmag.com	pumperttrader.com
pumper.com	septicyellowpages.com
onsiteinstaller.com	sewerpages.com

Cole Publishing
1.800.257.7222 • 715.546.3346

WWW.ROOTERMAN.COM



Franchises available with low, flat fee
New concept. Call 1-800-700-8062.
FRANCHISE PACKAGE \$7,950.

Custom Built High Flow Jetters



20 GPM @ 3000 PSI

Trailers, Van Kits, Portables

13-180 HP
4-42 GPM @ 4000 PSI
4-72 GPM @ 2000 PSI

AmericanJetter.com
866 9HI-FLOW

"TORNADO WARNING"



1/4" MINI 3/8" MINI

Introduced in 2007 the all new MINI TORNADO revolving nozzle series for your smaller cleaning needs that require the same patented power and performance of the larger Hydro Tornado's. The MINI TORNADO'S are designed for the smaller machines. Available for 1/4" and 3/8" hose with outputs of 3 to 25 G.P.M. The MINI TORNADO'S are recommended for 2" to 6" diameter pipes.



The "Hydro Tornado" Revolving Sewer Nozzle

- 3 Interchangeable forward jets
- 2 Revolving Jets with replaceable carbide inserts
- 5 Rearward Jets
- Available for 1/2", 3/4" and 1" Hose
- Available from 12 thru 80 G.P.M.

Call for pricing or see our complete line of nozzles, skids and root cutters on the web at:

www.breakthrumfg.com

TOLL FREE 1-866-415-4655

Break Thru Manufacturing
P.O. Box 87893 • Canton, MI 48187

We Make Trades
Pipe Bursting Equipment

FINALLY AN EASY-TO-USE SYSTEM

SEWER • WATER • GAS LINES

Install Any Type of Pipe 1/2" to 30"
Component Based & Light Weight
Rugged Full Power 20-, 30-, 40-Ton Units

New and Used Equipment

Email: sales@pipegenie.com
www.pipegenie.com

Call Toll Free 877-411-7473

I & I Solutions
INSTALL IN CLEANOUTS & MANHOLES



- Cleanouts 4" or larger
- For low flow areas
- Monitor new housing developments
- Battery operated
- An ultrasonic level measuring device

I & I SPY
VISIT OUR WEB SITE
www.twiispy.com

toll-free: **1.800.820.1321**
e-mail: info@twiispy.com



"CUACLAWs"

A Simple Solution for Slippery PVC Pipe -
The Right Wheels

CALL JERRY AT 714-697-8697
web: www.cua-claws.com



Cleaner Marketplace
advertising

Cleaner Marketplace gives you nationwide exposure to thousands of industry professionals.

Layout and design is included **FREE**, and we can fax or e-mail you a proof for final approval!

Now Available In 4-Color

Choose a size that works best for you!

Call 1.800.257.7222

Size A: \$309^{00*}	Size B: \$209^{00*}	Size C: \$109^{00*}
1.875" W x 4.875" H	1.875" W x 3.2" H	1.875" W x 1.5" H
This size is great for two photos!	Perfect size for one photo!	A great value!

*Black and white prices, call for 4-color pricing.

Send ad materials and payment to:
COLE PUBLISHING INC. • P.O. BOX 220 • THREE LAKES, WI 54562



RIDGID®

800.654.8003

One of the Largest Stocking Distributors
in North America



TOOLUP®.COM

Professional Contractor Supplies



Cleaner TRUCK STOP

see photos in COLOR at www.cleaner.com



2000 US Jett 10K and 4K: 600 gal. tank, 100 hp Deutz, 747 hrs., mounted in 14' heated box on a 2000 Chevy 6500, 45K, Cat dsl., excellent condition.
641-673-9377 or 641-660-6991 CBM



1994 Vactor 2110C Series on Ford LN 8000: 1129 hrs. on Vactor, 24,814 miles, 80 gpm @ 2000 psi, articulating hose reel, 4' extendible boom, hydraulic rear locks, 600' hose, 10 cu. yd. debris tank, 1,000 gal. water tank.\$37,500
800-999-6286 or 800-289-6225 C4



1998 GMC Cues TV System: Approx. 1,700 L.F. of multi conductor cable, pan & tilt, Shorty transporter, washdown system, lots of storage. Good condition. Ready to work. Financing available.\$55,000
Kelly 608-279-2299 CBM



1998 IHC 4900, Sreco HV-2000 Sewer Jet: 6 cylinder John Deere diesel upper, DT-466, Allison automatic, 55,115 miles, 1,894 hours. ..\$39,900
814-696-4343 - Hollidaysburg, PA C4



1994 Vactor 2110C Series on Ford LN 8000: 2264 hrs. on Vactor, 43,880 miles, 80 gpm @ 2000 psi, articulating hose reel, 4' extendible boom, hydraulic rear door locks, 575' hose, 10 cu. yd. debris tank, 1,000 gal. water tank.\$45,000
800-999-6286 or 800-289-6225 C4



1982 Jet Vac, Vactor 810: New water pump, new Ford 300 vac engine. Works well. New 8' pump hose. Money maker! Call me and I will send additional photos.
Joe @ 801-807-8335 CM4



Shower and Restroom Trailers: Platinum and Gold Series, new and used available. Each with separate men and women sides.
CCI/Brian Touey 805-896-3777 CBM

BE ONLINE AND IN CLEANER, MSW OR PUMPER FOR ONLY \$125 PER PUBLICATION! JUST GO TO WWW.CLEANER.COM, WWW.MSWMAG.COM or WWW.PUMPER.COM AND FILL IN THE ONLINE TRUCK STOP FORM!



Two 1990/91 VacCon V390 Combo Units: Rated @ 80 gpm, 2000 psi; and 35 gpm, 3000 psi. Very low miles and hours. Municipal owned.\$75,000
800-242-1494 C4

BE ONLINE & IN CLEANER, MSW OR PUMPER FOR ONLY \$125! Please print ad legibly with correct punctuation and PHONE NUMBER. Don't forget to send photo!

RATE \$125 PER AD, PER MONTH, PER PUBLICATION WITH A 30 WORD MAXIMUM - PLEASE NOTE: You can only advertise **ONE TRUCK** for sale per ad.

DEADLINES CLEANER & MSW: 1st OF THE MONTH • PUMPER: 10th OF THE MONTH - For example: Jan. 1st would be the deadline for Feb. Cleaner.

ADVANCE PAYMENT NO BILLING FOR TRUCK STOP ADS. Payment must be received in **ADVANCE** before publishing.



Municipal Owned 1988 Myers MHV7 Reconditioned Flush Truck: D65-20 pump, rebuilt aux. engine, S/S 2000 gal. tank, 500' new hose, 2 standard nozzles, rear repainted, turnkey.\$51,500
800-242-1494 C4

Enclosed is \$ _____ for _____ ad(s) to run _____ month(s) in

CLEANER MSW PUMPER/Pumper Trader ALL 3 PUBLICATIONS (TRIPLE DOLLAR AMOUNT)

Company Name _____

Address _____ Phone _____

City _____ State _____ Zip _____

PLEASE FILL OUT CREDIT CARD INFORMATION COMPLETELY: CREDIT CARD NO. _____ V-CODE _____ EXP. DATE _____

CARDHOLDER NAME _____ PHONE _____

• **MAIL** this completed form with payment and photo to: COLE Publishing Inc., P.O. Box 220, Three Lakes, WI 54562 (Make check/money order payable to: COLE Publishing Inc.)

• **ONLINE** ad form at: www.cleaner.com, www.mswmag.com or www.pumper.com

• **FAX** this completed form to: 715.546.3786 and **E-MAIL** photo to: truckstop@mswmag.com, truckstop@pumpec.com, truckstop@cleaner.com

PLACE YOUR AD ONLINE AT www.cleaner.com - IT'S ALWAYS THERE TO MEET YOUR BUSY SCHEDULE



Go **GREEN** with **CUES Blue!**

Improving your environment, one pipeline at a time.

For over 40 years, CUES has provided CCTV pipeline inspection solutions by combining industry know-how, top-of-the-line equipment, and the most responsive customer service in the industry. CUES offers the highest caliber equipment available with a streamlined, one-stop shop for all of your pipeline inspection, rehabilitation, and profiling needs. If you're looking for ways to achieve precision condition assessment to accurately determine the course of your rehabilitation and capital improvement programs for your wastewater and stormwater systems, contact CUES for a discussion and demonstration.



Thanks for visiting us!

Custom Truck & Trailer-mounted Systems

Compact Pipe Ranger

6" Rubber



15" Pneumatic



K2 Portable Inspection System

The new K2 Series portable CCTV pipeline inspection system can be mounted in a range of vehicles, trailers, or used as a stand-alone system and includes an ergonomic hand-held control with a wireless option that operates all CUES transporters and cameras.



Mini-Push 20/20



"The Standard of the Industry"



800.327.7791
www.cuesinc.com
salesinfo@cuesinc.com

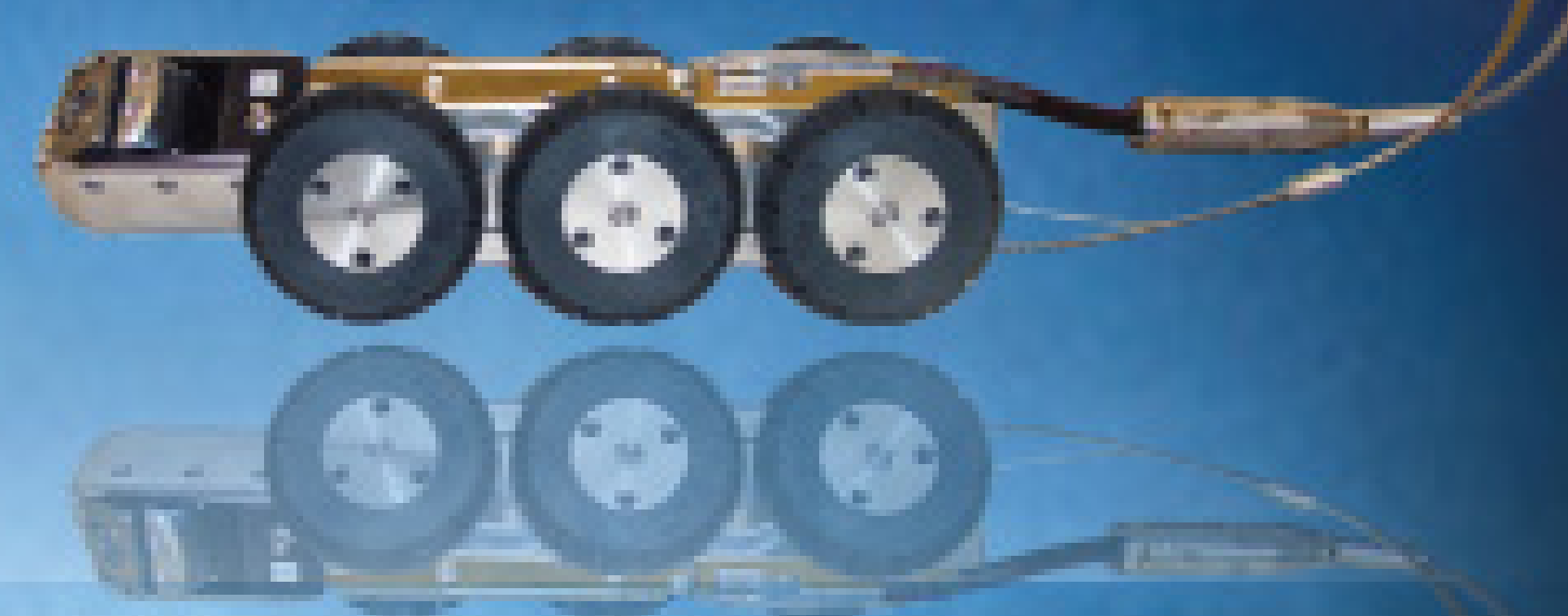

Space-Saving Features Mark Camera Inspection System

By Ken Wysocky

Space-conscious drain cleaners will appreciate the all-in-one design of the Intruder Elite family of video inspection systems from Vision Technology Design & Manufacturing Inc.

The systems include an integrated monitor and detachable push-rod reels. The camera monitor is built into a lightweight frame and does not have to be carried separately to the job, says company president Jack Felix.

"We went down that road because technicians' trucks are becoming so crammed with equipment," Felix says. For technicians who find it difficult to view a monitor outdoors on a sunny day, the 7-inch, high-resolution LCD screen has a sun shield and LED brightness control. It provides a clear picture from any angle that is "as close

as you can get to glare-free," Felix says.

A picture inverter enables technicians to rotate upside-down images so they appear upright. The unit also has an on-screen footage counter and text writer. Users can choose an optional digital video recorder (DVR) or DVD recorder. Video footage can then be downloaded and e-mailed to a customer. The unit is compatible with any conventional video recording device, Felix notes.

The reel carries a 100-foot push rod with 1-inch-diameter micro camera head, or a 200-foot push rod with a 1.3-inch mini-camera head. The camera heads are available in black-and-white or color. The reels are detachable and interchangeable, enabling users to inspect 1- to 6-inch pipes.

A dual-frequency transmitter that broadcasts



Intruder Elite from Vision Technology Design & Manufacturing Inc.

at 512 HZ and 874 Hz works with any locator to pinpoint the location and depth of the camera head down to 12 feet. The unit runs on 12-volt DC power (with an AC wall adapter) or a built-in rechargeable battery that provides four hours of continuous use. **For information: 877/724-3435; www.vtdesign.com.**

General Pipe Introduces Lightweight J-2900 Jetter

The maneuverable Jet-Set J-2900 gas-powered waterjetter from General Pipe Cleaners weighs 173 pounds, offers 3,000 psi, and measures 25 1/2 inches long, 28 1/2 inches wide and 42 inches high. Powered by an 11-hp Honda engine, the unit features a 4-gpm triplex pump with Vibrapulse on demand. A 300-foot capacity hose reel with reel brake and brass swivel is mounted on a heavy-duty frame with two pneumatic tires. Safety features include a thermal relief valve, back-flow check valve and inlet filters. **For more information: 800/245-6200; www.drainbrain.com.**



QuickView Adds Accessory Package

Envirosight LLC has added an extended targeting leg, pole extensions and an updated display/recorder to its QuickView zoom inspection camera system. The adjustable carbon-filter targeting leg attachment enables users to inspect drop lines, while the 6-foot pole extension can add 6-18 feet of depth, enabling the camera to inspect manholes as deep as 48 feet. The camera's 7-inch color LCD video display provides nine times the pixel resolution of its previous 4-inch screen and has been updated to support high definition. The unit's memory card capacity also has been increased. **For more information: 866/936-8476; www.envirosight.com.**



RIDGID Extends Press Products Line

ProPress Rings from RIDGID are available in 1/2-, 3/4-, 1-, 1 1/4-, 1 1/2- and 2-inch sizes, enabling users to press connections in less accessible areas. The rings have a swivel design with 180-degree rotation for connection at almost any angle. Kits for pressing up to 4-inch bronze and copper fittings are available. **For more information:**

800/769-7743; www.ridgid.com.



Electric Eel Releases Counter-top Model

The CT counter-top cleaning machine from Electric Eel Manufacturing Co. Inc. offers a variable-speed motor for maximum cable control, and a power range of 75 to 350 rpm with constant torque. Designed to clean up to 50 feet of 3/4- to 2 1/2-inch drains, the unit features a 1/5-hp, 90-volt DC motor, stainless-steel drum and air-operated foot switch and cord assembly. It can run 1/4-, 5/16- and 3/8-inch cable. A hand-tighten Jacobs Chuck is standard, and a two-way auto-cable feed is available. **For more information: 800/833-1212; www.electriceel.com.**

NLB Offers UHP Waterjet Lance

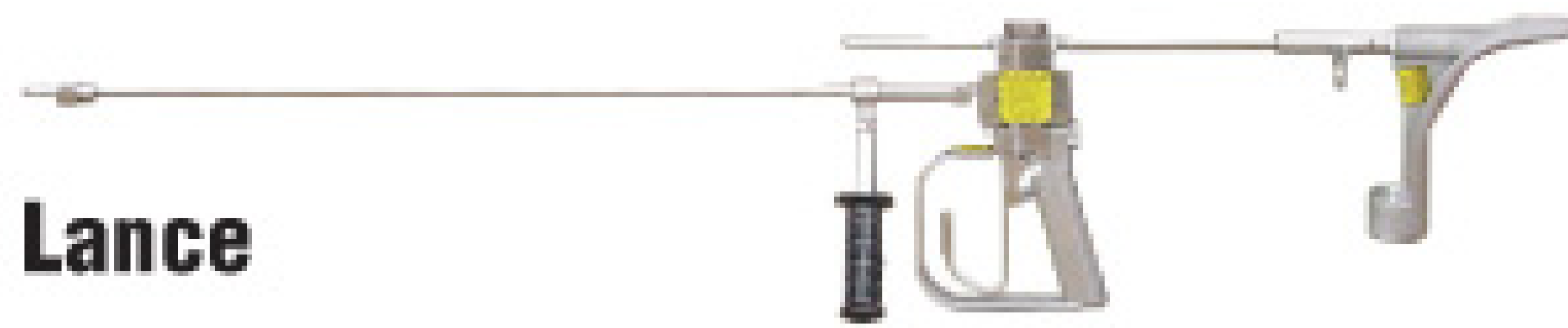

The NCG40-286 ultra-high pressure waterjet lance from NLB Corp. delivers 40,000-psi and features a one-finger latch design to prevent accidental actuation and 60-second cartridge change. It weighs 13.5 pounds, and has an adjustable hand grip and shoulder stock. When used with the Viper 40 self-rotating head, it can produce rotating waterjet action without compressed air. **For more information: 248/624-5555; www.nlbcorp.com.**

Ace Supply Develops Mobile Vac Boom

Designed for hydro-excavating or vac-excavating, the Mobile Vac Boom flex-hose extension from Ace Supply attaches to a mini-excavator, excavator, skid-steer or backhoe, providing greater safety and more precise excavation. **For more information: 814/899-3644; www.mobilevacboom.com.**



Clear Computing Launches Centralized Reporting

Clear Computing has added centralized financial reporting for external divisions to its Total Activity Control operations management

system. The new feature enables users to access and run individual or combined reports, wherever they are located. Reports can be viewed, e-mailed or exported into Excel. **For more information: 888/332-5327; www.clearcomputing.com.**

Water Cannon Designs Undercarriage Attachment

The Mud Cannon undercarriage cleaner from Water Cannon attaches to a pressure washer hose and requires only 5 1/2 inches of clearance. Featuring a stainless-steel Mosmatic swivel and spray bar, the spinning 4-nozzle rotating assembly cleans an approximately 24-inch area. The unit has a telescoping handle and can withstand temperatures up to 195 degrees F, as well as almost any type of liquid chemical or acid solution. **For more information: 800/333-9274; www.watercannon.com.**



Ditch Witch Releases 250R/T Locating System

The 250R/T locating system from Ditch Witch is designed to locate and avoid buried telephone, CATV, power, gas and water lines. The unit features a 250T transmitter and 250R receiver. It offers intuitive controls, an easy-to-read display and depth estimation up to 15 feet. Tones are derived from the actual signals radiating from pipes or cables. The display is backlit and reinforced with a scratch-resistant coating for optimal visibility day or night. **For more information: 800/654-6481; www.ditchwitch.com.**

Duracable Introduces Upright Cable Cleaner



The DM 175 Gladiator cleaning machine from Duracable Manufacturing Co., comes with 100 feet of 3/4-inch cable and features a 1/2-hp motor with 10:1 gear ratio that operates at 145 rpm, 175 rpm or 215 rpm. The unit has a three-position adjustable handle that locks in place with a lanyard. The frame has an integrated toolbox and is balanced to prevent against "dancing," even with all the cable out. Stair climbers are standard, while horizontal support legs and loading wheels are optional. Swing bolts on each side of the head bearing allow for quick reel release. **For more information: 800/247-4081; www.duracable.com.** ♦

35,000 MUNICIPAL AND UTILITY MAINTENANCE PROFESSIONALS READ IT EVERY MONTH. DO YOU?

A subscription is FREE. www.mswwmag.com or 800-257-7222

MUNICIPAL
SEWER
&
WATER

It's A Bag Full

cleaner.com

- > Classifieds
- > Truck Stop Ads
- > E-zines
- > Product Categories

www.drainmachines.com

Electric Eel Manufacturing
Drain & Sewer Cleaning Equipment
by **PIPE TOOLS INC**
2008 Catalog Available Now

TRY TEK Machine Works, Inc.

FAST DELIVERY
on
replacement parts

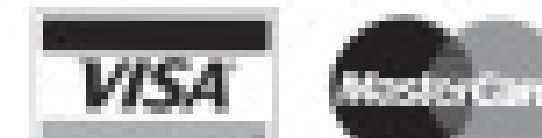

We accept VISA or MasterCard



Contact us for more information:
Phone: 717-428-1477
Fax: 717-428-2865
Email: trytek@trytek.com

250 N. Main St.
Jacobus, PA 17407
USA

**Hundreds
in use!**

www.trytek.com
6" to 15" Tap Cutter

Serving the
industry for
21 years

814.535.6766



NEW TOWN...NEW VENUE...SAME ATTITUDE!

GapVax®

Setting the standard...as The World's Most Advanced Manufacturer of Industrial and Combination JetVac Equipment!

Thank you for attending the show...give us a call...let us know what we can build for you!

EELCAM™ PIPELINE INSPECTION SYSTEMS

EC-200 SYSTEM

STANDARD FEATURES:

- Inline Sonde
- Counter
- Keyboard
- VCR
- Microphone
- Picture inverter
- Centering skids
- Camera test port
- DC adapter
- Lightweight 30" cable reel with brake



AVAILABLE
WITH "SELF-LEVELING"
COLOR CAMERA

**NOW
AVAILABLE
WITH
DVD!!**

All units available with DVD recorders

EASY
ACCESS
TO ALL
CONTROLS –
FLIP-DOWN
KEYBOARD



CONTROL
UNIT WITH
WHEELS –
HANDLE
FOR EASY
TRANSPORT



OTHER SYSTEMS AVAILABLE!

DRAIN CLEANING TOOLS FOR PROFESSIONALS

Electric Eel®

1.800.833.1212
www.electriceel.com

THE WARRIOR. THE SOLDIER.

NOW REPORTING FOR DUTY.



Spartan Soldier

Spartan Warrior



SPARTAN
FOR TOUGH CUSTOMERS.
SINCE 1943

Introducing the industry's sleekest, quietest trailer jets ever. Spartan's fully enclosed, 4,000 PSI Warrior and stealthy 3,000 PSI Soldier feature exclusive soundproofing technology for engine noise below OSHA's strict standard for mandatory hearing protection. What's more, both come packed with all the power and performance you expect from the most trusted name in the business. Spartan. Innovation comes standard.



Pop the hood: Uncover all the hard-hitting features and specs at spartantool.com

CONTACT US TODAY | 800.435.3866